



Volume 2

COMPOSIZIONE
MODULARE

con origami modulari

Nastri
Stelle
Girandole
Ghirlande



Franco Pararin

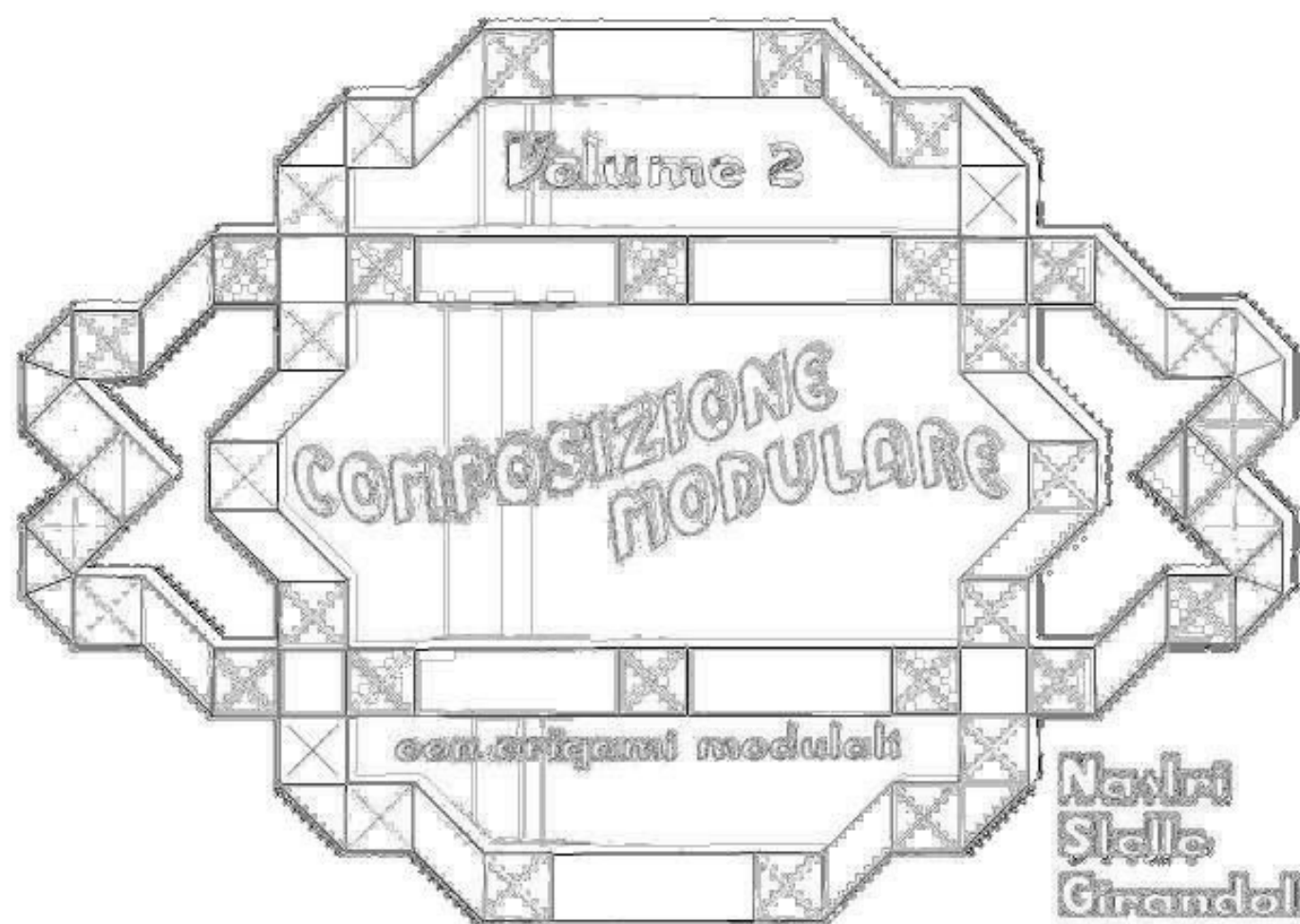

Volume 2

COMPOSIZIONE MODULARE

con elementi modulari

Nastri
Stelle
Girandole
Chirlande

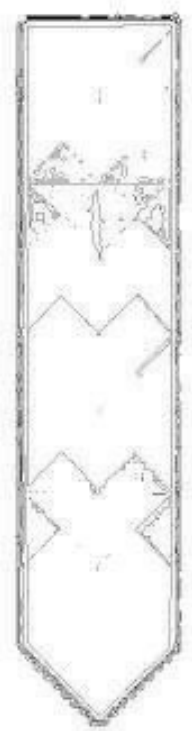
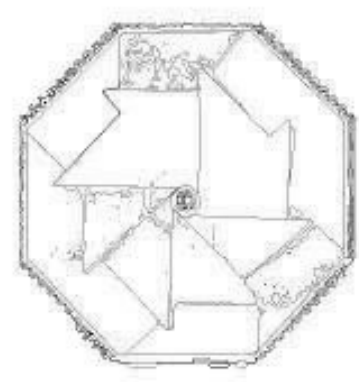
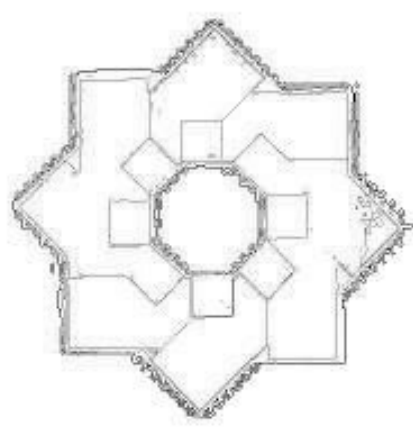
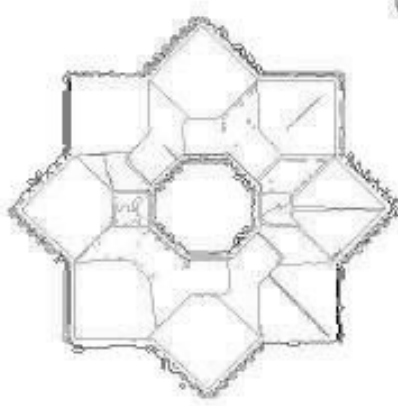
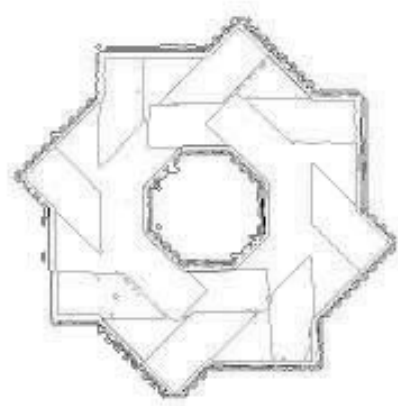
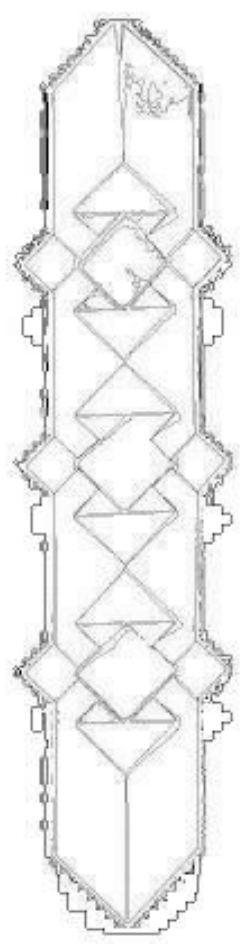

francesco Pavarini

PREFAZIONE

Questo mio ultimo lavoro comprende anche materiale sparso già pubblicato ma che sarebbe andato perduto dopo la chiusura del mio sito: "Moduli elementari" e "Nastro azteco".

Le novità consistono in un discreto numero di ghirlande, nastri e girandole, il tutto costruito, ovviamente, senza l'uso di colla e forbici.

Ringrazio Antonio Coiana quale presidente del Centro Diffusione Origami per l'ospitalità data ai miei libri.

Gli schemi di piegatura di singoli modelli saranno invece pubblicati nella mia pagina Instagram.

I miei prossimi libri di composizione origami conterranno principalmente schemi di modelli di tassellazioni e poliedri.

Gennaio 2023

Franco Pavarin

This latest work of mine also includes scattered material already published but that would be lost after the closure of my site: "Elementary modules" and "Aztec tape".

The novelties consist of a fair number of garlands, ribbons and pinwheels, all constructed, obviously, without the use of glue and scissors.

I thank Antonio Coiana as president of the Origami Diffusion Center for the hospitality given to my books.

The folding patterns of individual models will instead be published on my Instagram page.

My next origami arranging books will mostly contain pattern diagrams of tessellations and polyhedra.

Este último trabajo mío también incluye material disperso ya publicado pero eso sería perdido tras el cierre de mi sitio: "Módulos elementales" y "Cinta azteca".













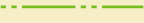













Las novedades consisten en un buen número de guirnaldas, cintas y molinetes, todos contruidos, obviamente, sin el uso de pegamento y tijeras.

Agradezco a Antonio Coiana como presidente del Centro de Difusión de Origami por la hospitalidad brindada a mis libros.

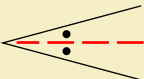
En cambio, los patrones de plegado de modelos individuales se publicarán en mi página de Instagram.

Mis próximos libros de arreglos de origami contendrán principalmente diagramas de patrones de teselaciones y poliedros.

Simbologia origami

	Indicazione	Risultato 3D
 Piega a valle (piega bassa)		
 Piega a monte (piega alta)		
 Ruotate e piegate		
 Ruotate, piegate e riportate alla posizione iniziale		
 Ribaltate sull'asse verticale		
 Ribaltate sull'asse orizzontale		
 Ruotate di 180°		
 Piega bisettrice a valle		
 Figura ingrandita		

Realizzazione delle pieghe rovesce

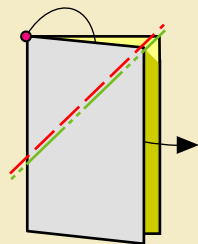

1

Eseguite una piega rovescia interna

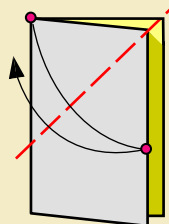

2

Una piega a valle

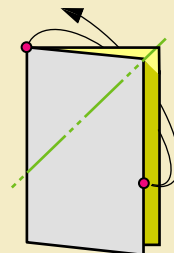

3

Ripiegate con piega a monte sulla medesima traccia

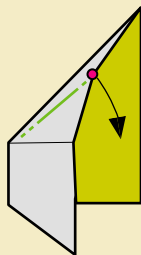

4

Aprite e rovesciate il verso della piega

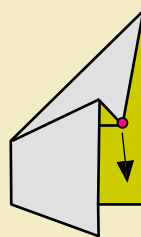

5

Inserite all'interno il vertice indicato

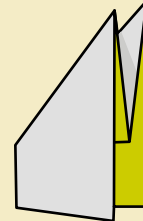

6

Piega rovescia interna ultimata

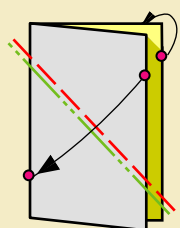

1

Eseguite una piega rovescia esterna

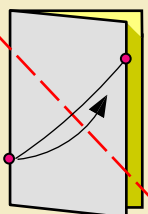

2

Una piega a valle

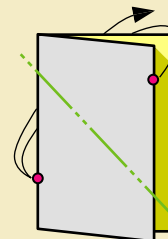

3

Ripiegate con piega a monte sulla medesima traccia

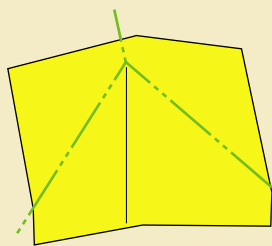

4

Aprite e rovesciate il verso della piega

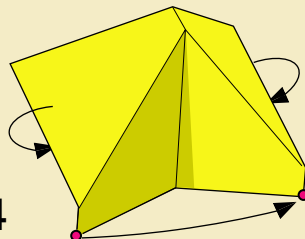

5

Richiudete

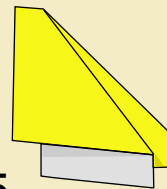

6

Piega rovescia esterna ultimata

MODULI ORIGAMI

elementari per
la costruzione di
nastri, stelle e ghirlande

ELABORAZIONI CON TRIANGOLI RETTANGOLI ISOSCELI 2017

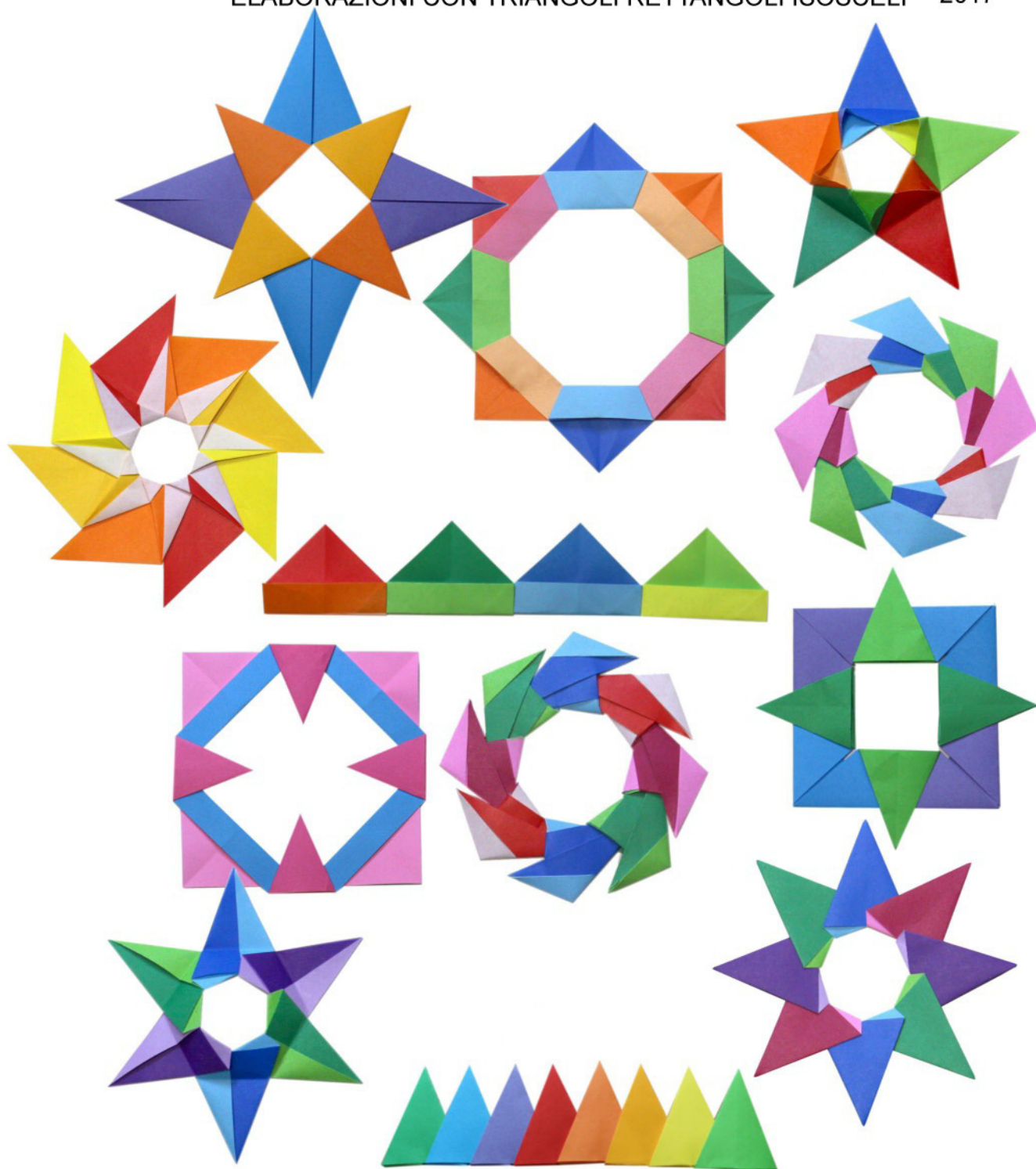

MODULI ORIGAMI

elementari

Con questa mia nuova sperimentazione ho provato a comporre decorazioni geometriche adoperando solamente moduli ottenuti dalla sezione del quadrato lungo una diagonale.

È risultata una serie di modelli molto semplici, adatti per uso scolastico-educativo (origami sociale), robusti, smontabili e modificabili.

Franco Pavarin, li 07/02/2017

Modulo base

Questo modulo è fondamentale perchè essendo dotato di 2 tasche laterali e 2 ganci inferiori permette unioni anche con altri moduli, sia rettilinee che circolari. Il passaggio 5 permette di scegliere di ottenere moduli bicolori.

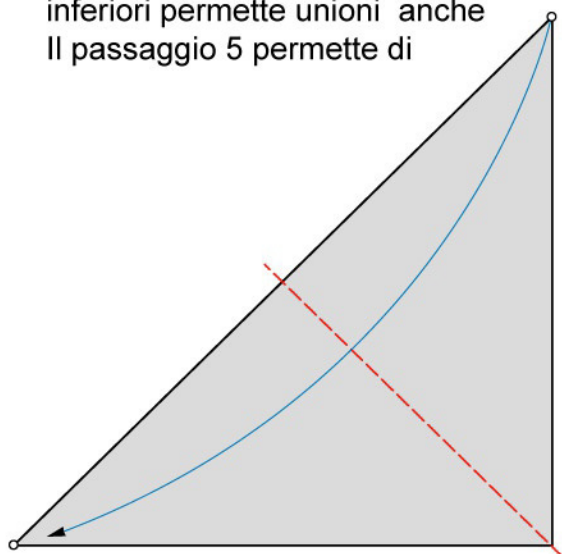

1 piega a valle

1

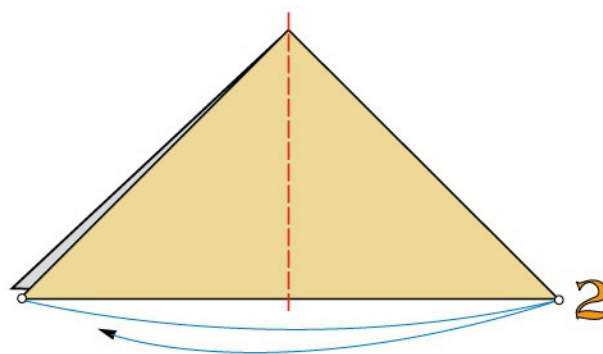

1 piega a valle solo sulla superficie in vista

2

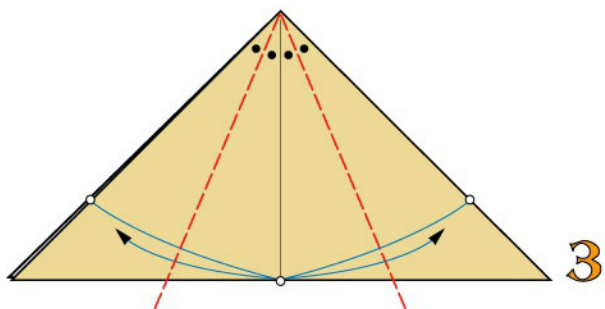

2 pieghe bisettrici a valle

3

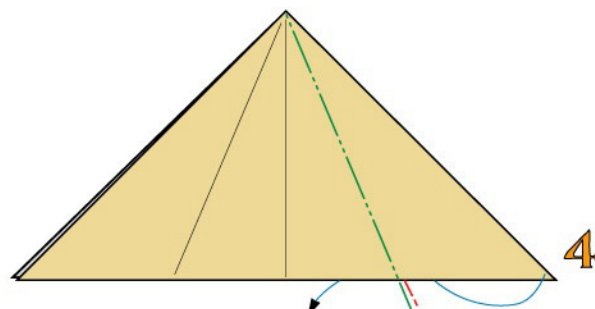

1 piega rovescia interna

4

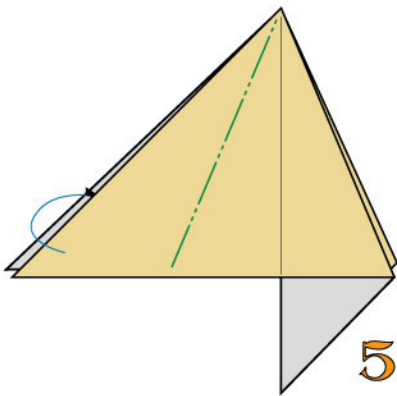

5
1 piega a monte solo
sulla superficie in vista

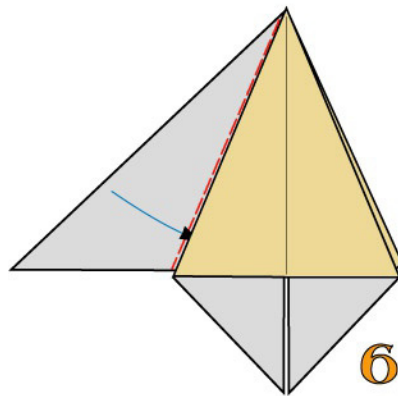

6
1 piega a valle
e intascate

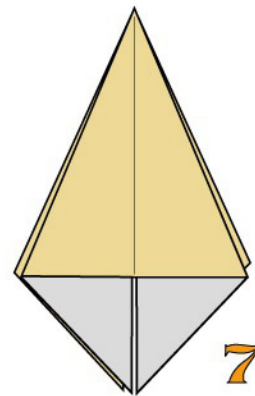

7
Modulo base
monocolore ultimato

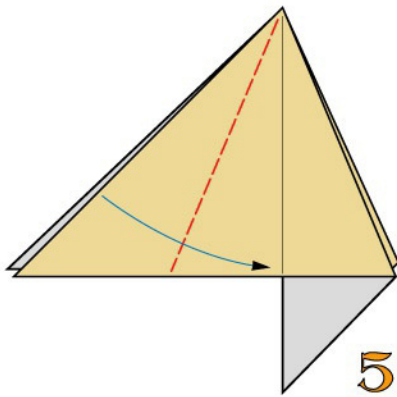

5
1 piega a valle solo
sulla superficie in vista

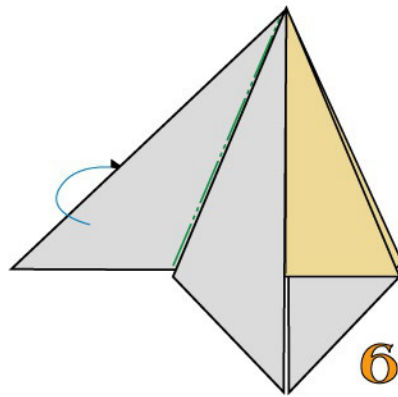

6
1 piega a monte

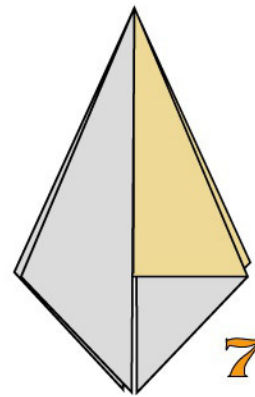

7
Modulo base
bicolore ultimato

Nastro "A"

Si realizza unendo moduli base in
successione



UNIONE DI MODULI MONOCOLORI

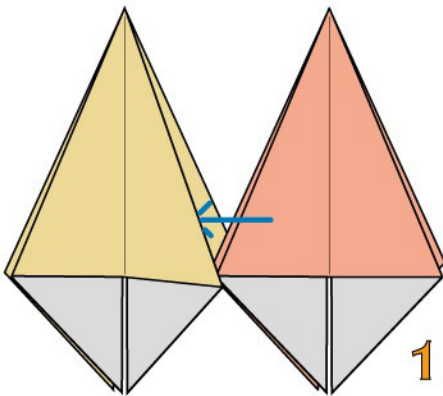

1
Inserite il modulo di destra
all'interno del modulo di sinistra

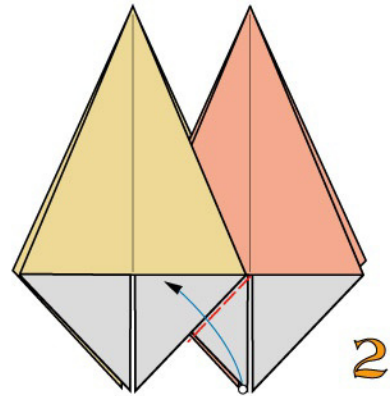

2
1 piega a valle

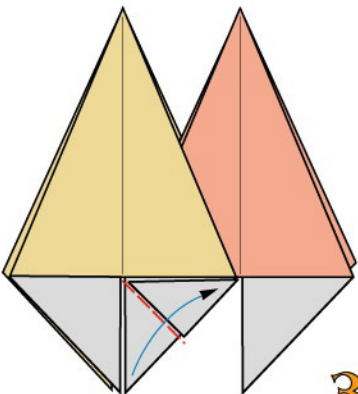

3
1 piega a valle

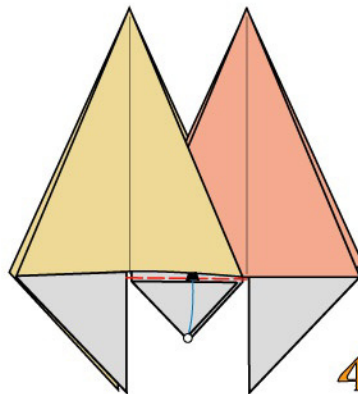

4
piegate ambedue i moduli con
1 piega a valle intascando

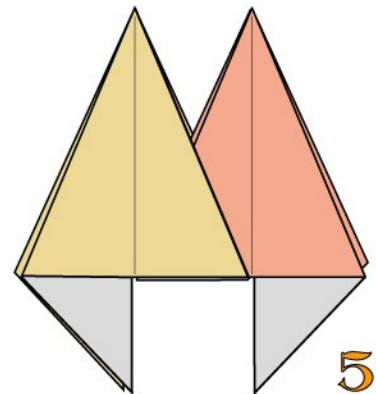

5
Unione di 2 moduli
monocolori completata

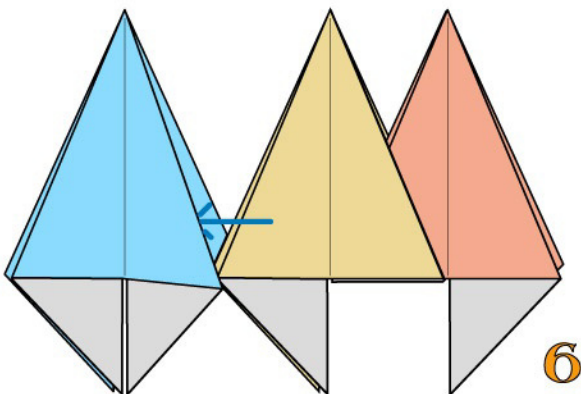

6
Inserite un nuovo modulo e bloccate
come già eseguito precedentemente

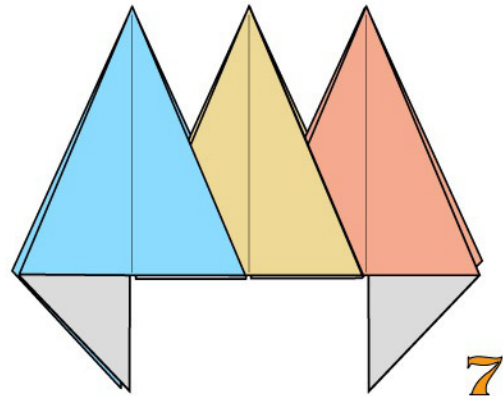

7
Unione di 3 moduli monocolori
completata. Ovviamente i ganci
inferiori del primo e dell'ultimo
vanno intascati e nascosti

Stella "A"

Con il modulo base si possono realizzare stelle piatte con 8 moduli, o stelle 3D con 4,5,6,7 moduli. Nella foto di destra sono stati adoperati 6 moduli bicolori, e sono state necessarie 6 pieghe a valle per far emergere l'anello centrale convesso.

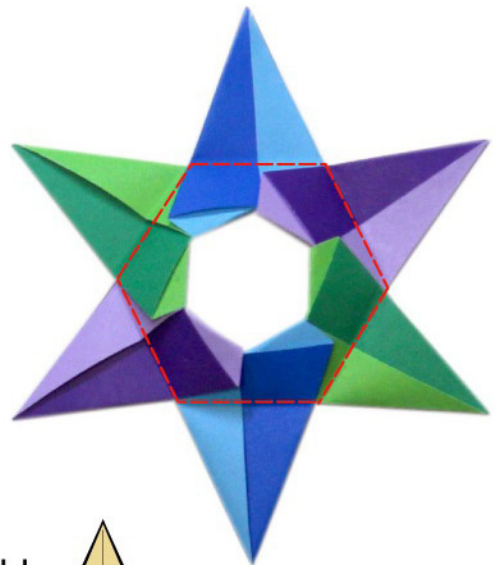

UNIONE DEI MODULI

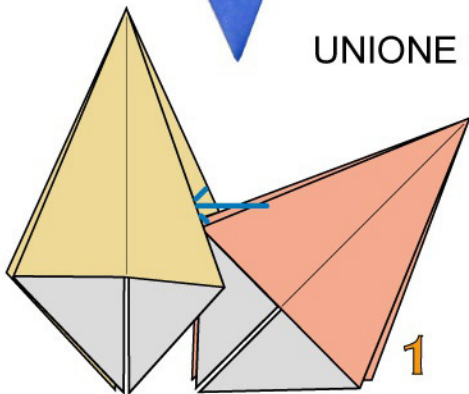

1

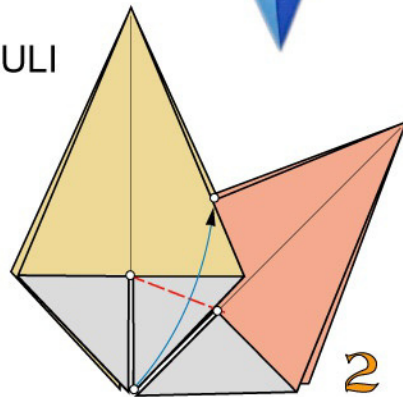

2

Inserite il modulo di destra, ruotato di 45°, all'interno del modulo di sinistra

1 piega a valle

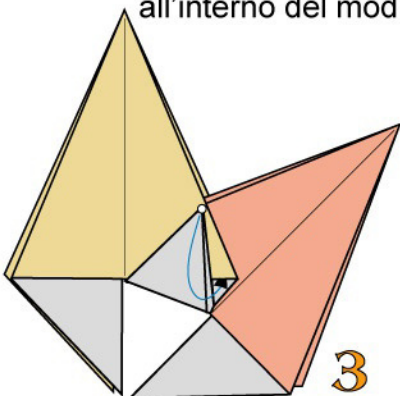

3

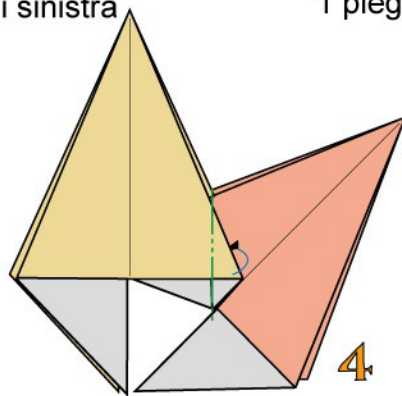

4

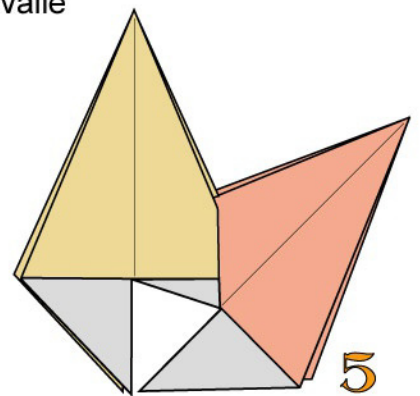

5

Intascate il vertice indicato

1 piega a monte ed intascate

Unione di 2 moduli "base" completata

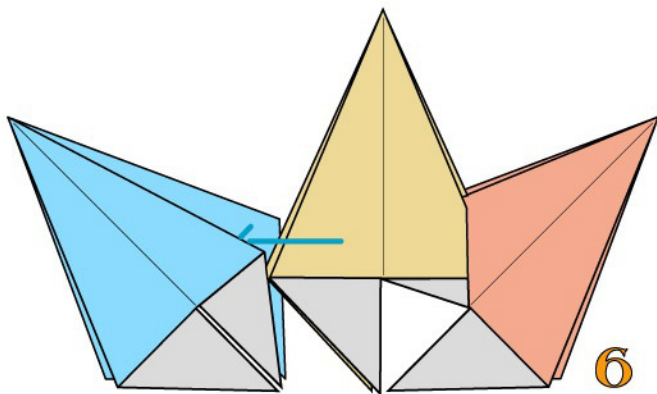

Inserite 1 altro modulo

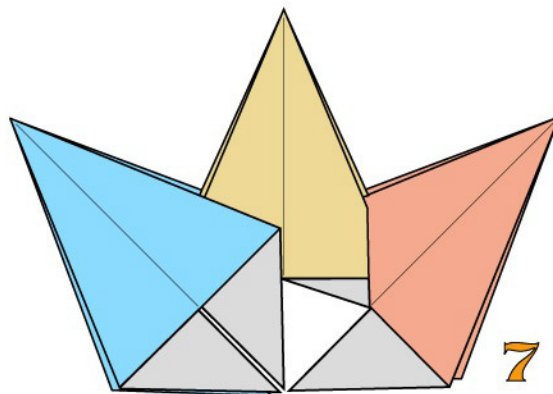

Bloccatelo come già visto nei passaggi precedenti

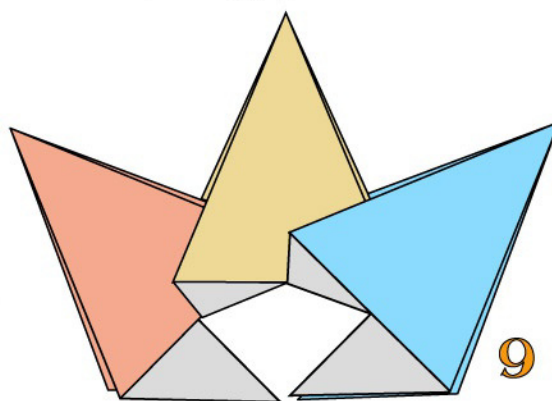
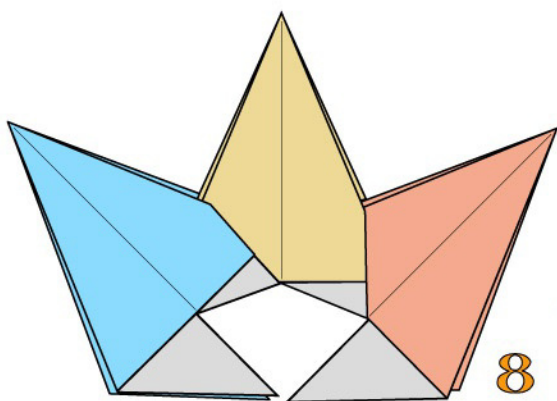

Unione di 3 moduli "base" completata. Ribaltate

Nella stella di sinistra è stata eseguita un'altra elaborazione 3D, aprendo 5 tasche e creando 5 piramidi cave sporgenti in corrispondenza delle giunzioni fra i moduli

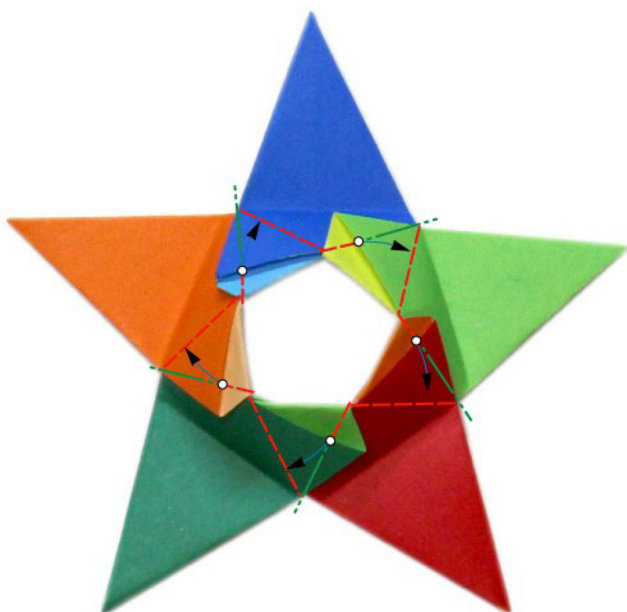

Stella "B"

Questa stella è formata da 4 moduli base e 4 moduli "B". Quest'ultimi sono semplicissimi, di grandi dimensioni e dotati solamente di 2 ganci inferiori e quindi gregari del modulo base. Carta indifferentemente monocolore o bicolore.

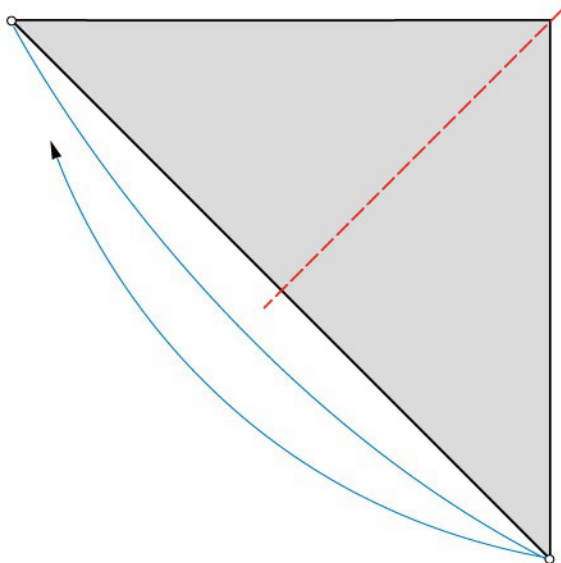
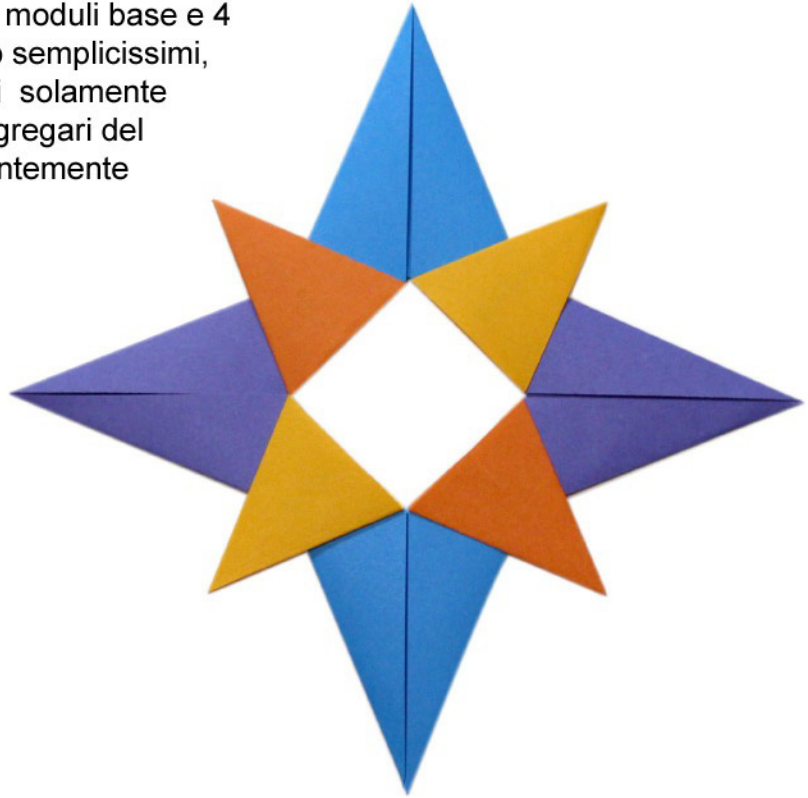

1 piega a valle

1

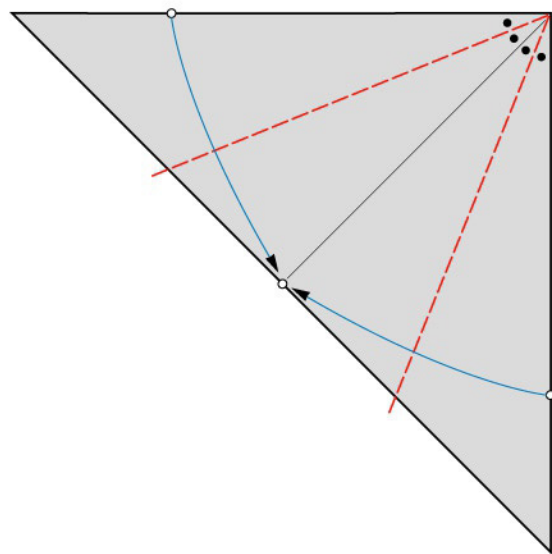

2 pieghe bisettrici a valle

2

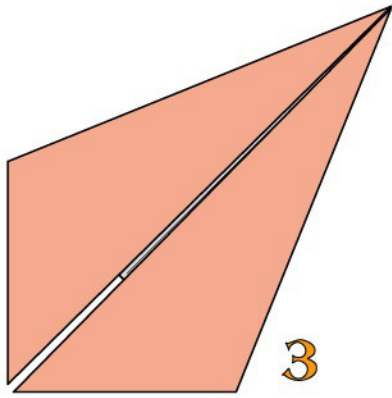

Modulo "B" ultimato

UNIONE DEI MODULI

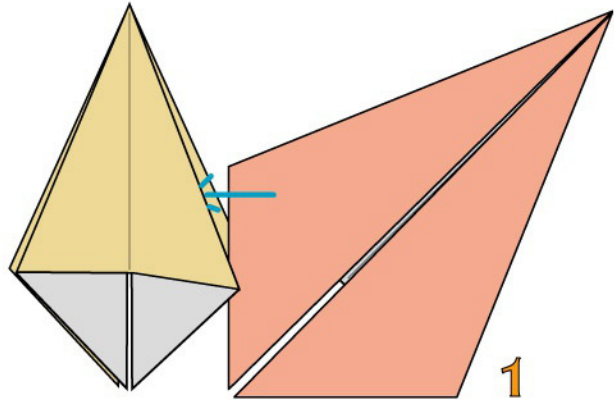

Inserite il modulo di destra all'interno del modulo di sinistra

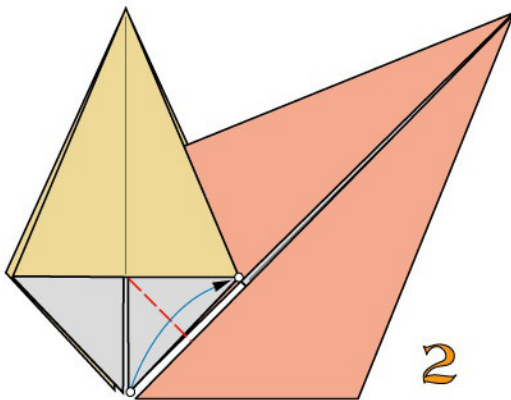

Piegate ambedue i moduli a valle

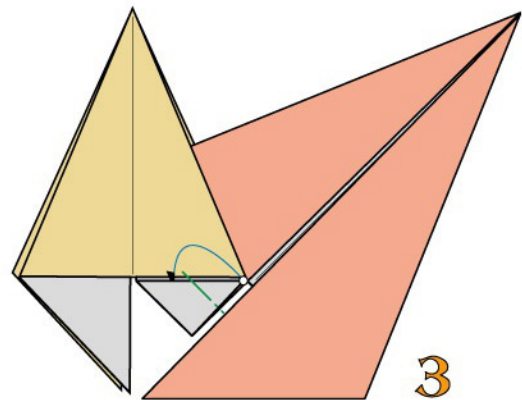

Ruotate ambedue i moduli con una piega a monte

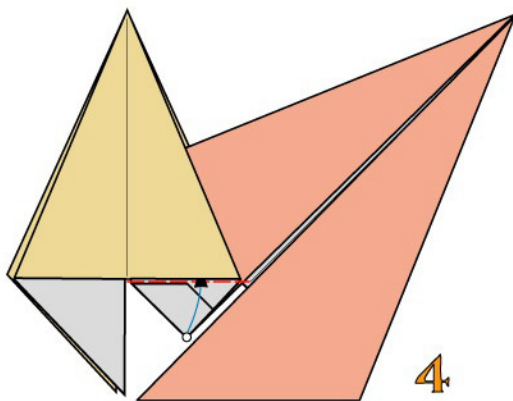

Con una piega a valle Intascate il vertice indicato

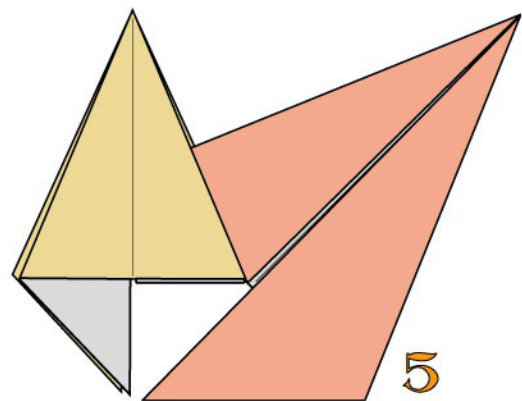

Unione dei moduli "base" e "B" completata

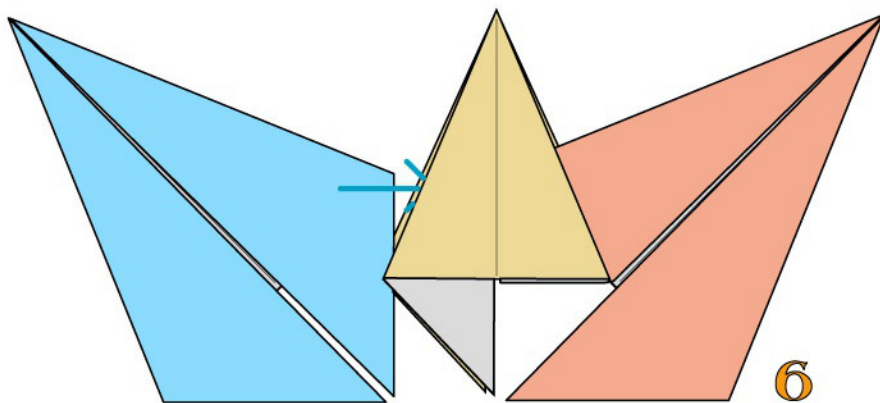

Inserite un nuovo modulo "B",
ruotato di 90° all'interno del
modulo base

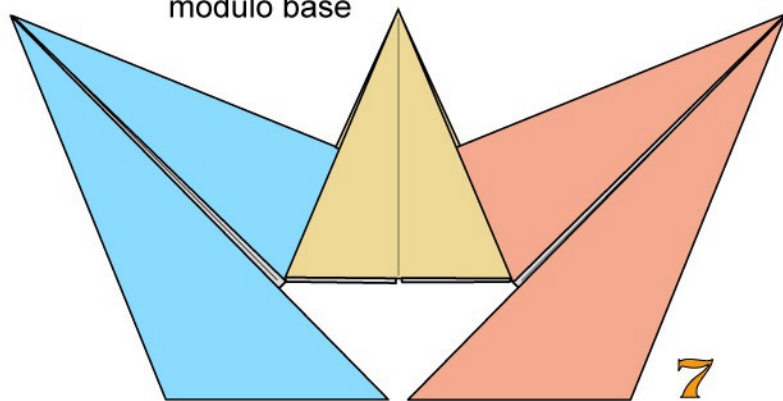

Bloccate il modulo "B" come
già visto nei passaggi precedenti

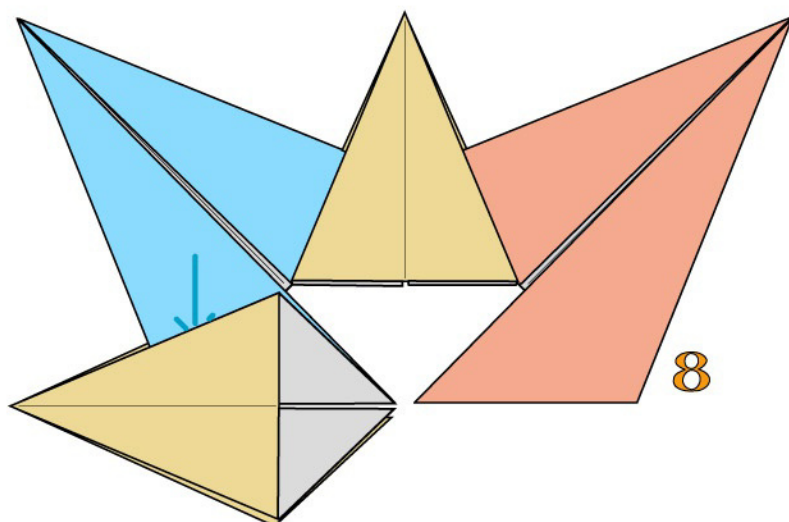

Inserite il gruppo in un nuovo modulo base ruotato di
90° e bloccate come già eseguito precedentemente

Stella "C"

Questa stella è formata da 4 moduli base e 4 moduli "C". Quest'ultimi sono semplicissimi, di grandi dimensioni e dotati solamente di 2 ganci inferiori e quindi gregari del modulo base. Carta indifferentemente monocolora o bicolore.

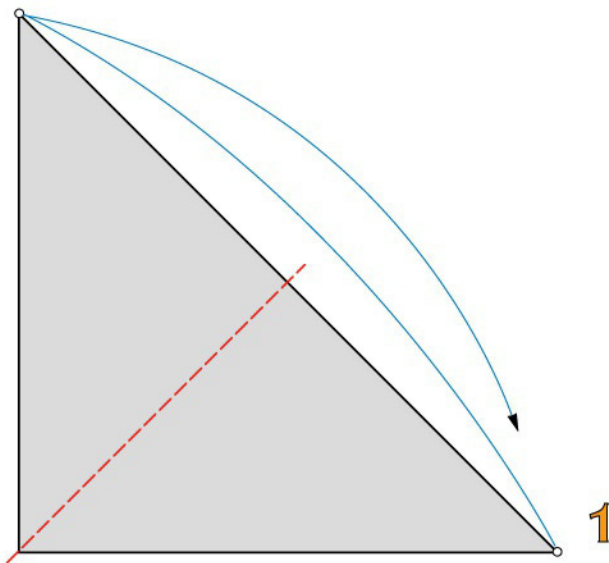
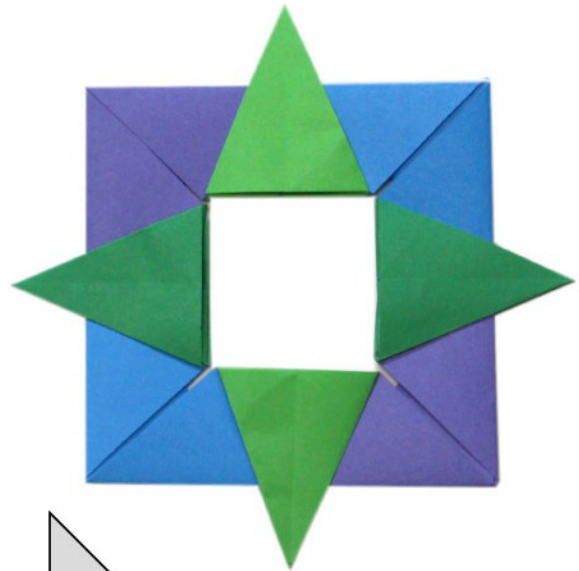

Costruzione del modulo "C".
1 piega a valle

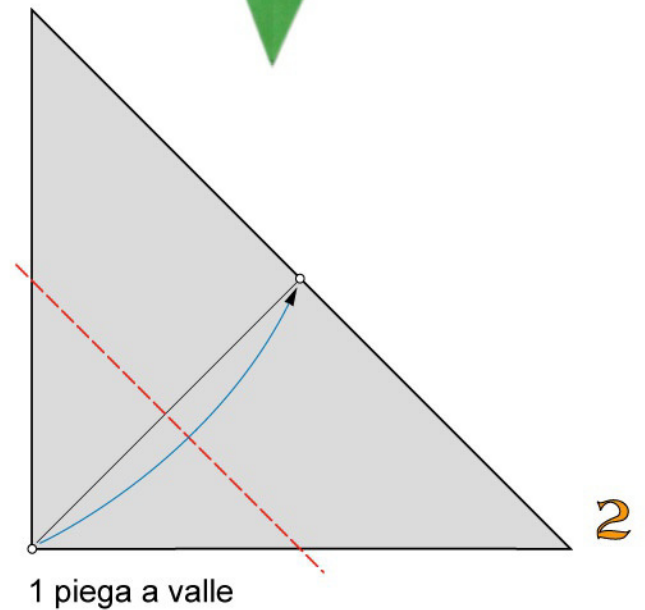

1 piega a valle

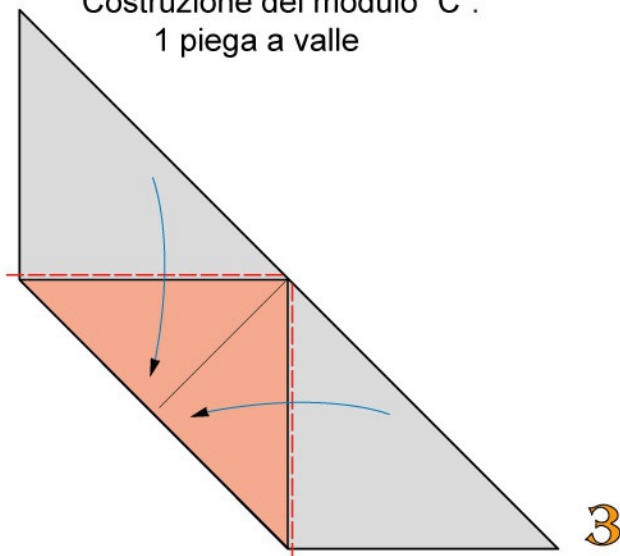

2 pieghe a valle

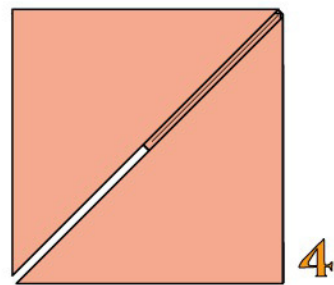

Modulo "C" ultimato

UNIONE DEI MODULI

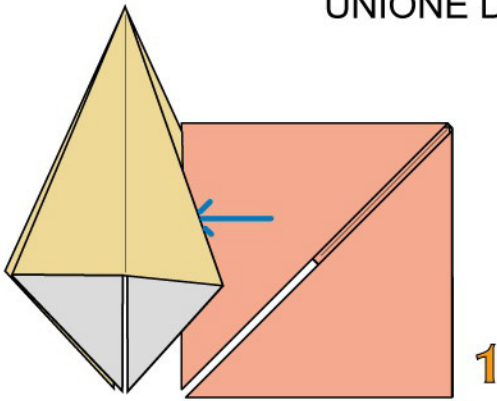

1
Inserite 1 modulo "C" all'interno di un modulo "base"

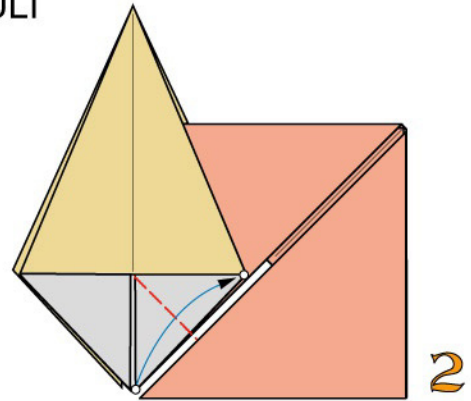

2
Piegate ambedue i moduli a valle

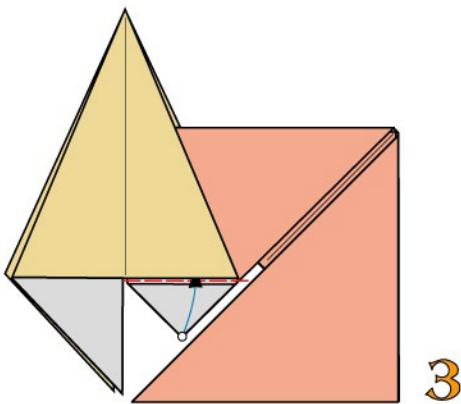

3
Con una piega a valle Intascate il vertice indicato

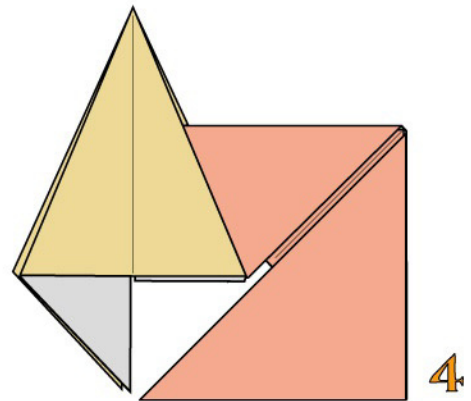

4
Unione dei moduli "base" e "C" completata

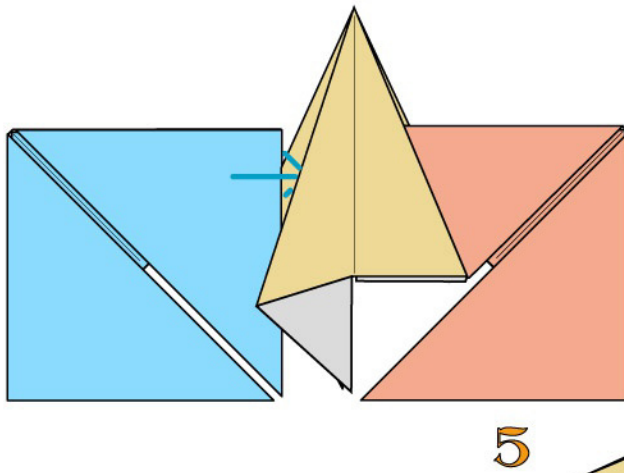

5
Inserite 1 altro modulo "C", ruotato di 90°, all'interno del modulo "base" e bloccatelo come già visto nei passaggi precedenti

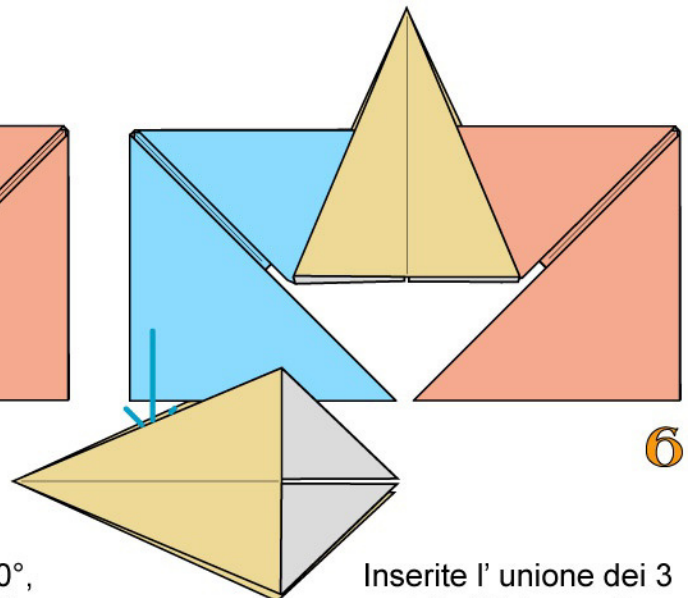

6
Inserite l' unione dei 3 moduli all'interno di un modulo base ruotato di 90°

Decorazione geometrica

Questa semplice decorazione è formata da 4 moduli base e 4 moduli "D".
Quest'ultimi sono semplicissimi, di grandi dimensioni e dotati solamente di 2 ganci laterali e quindi gregari del modulo base.
Carta indifferentemente monocolore o, meglio, bicolore.

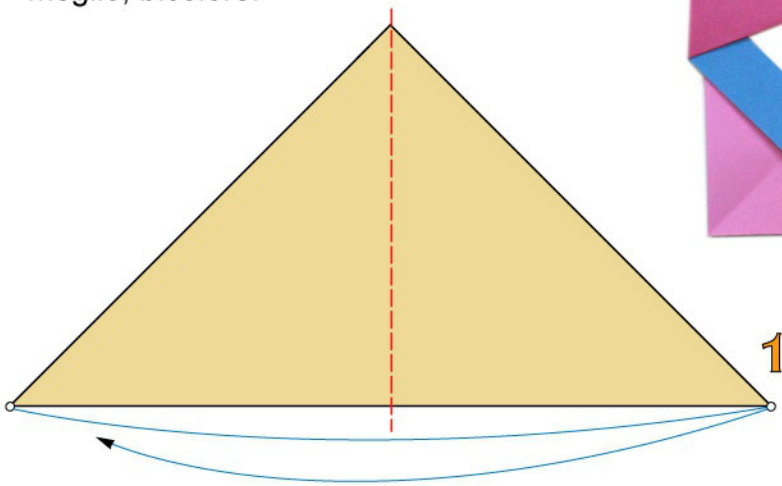
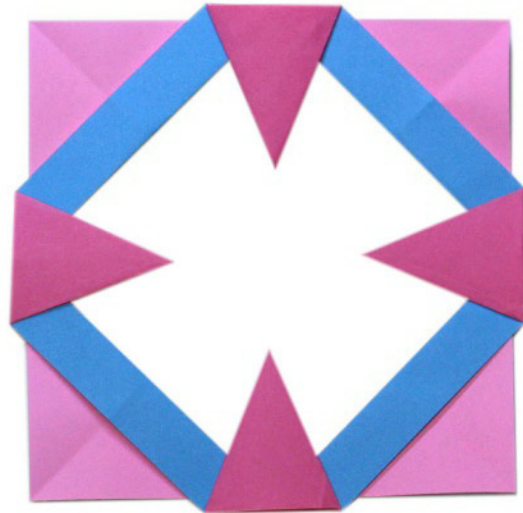

Costruzione del modulo "D".
1 piega a valle

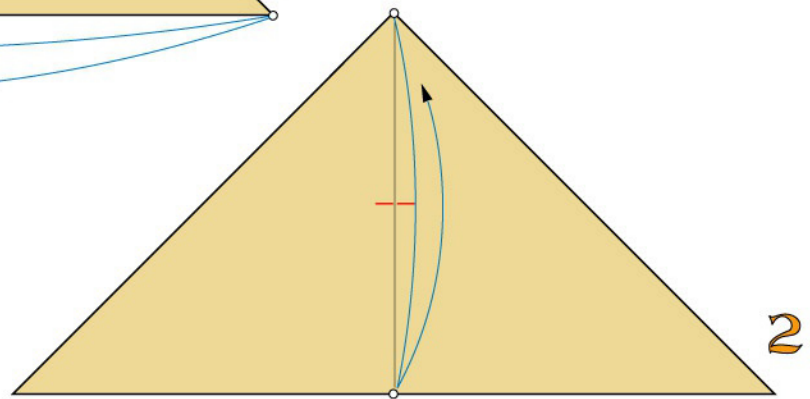

1 piccola piega a valle

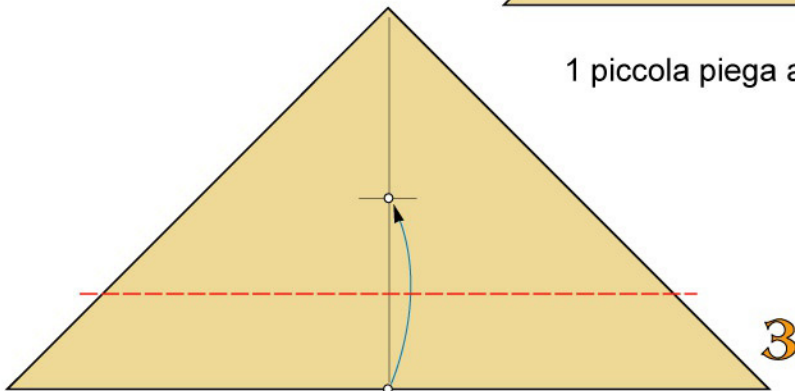

1 piega a valle

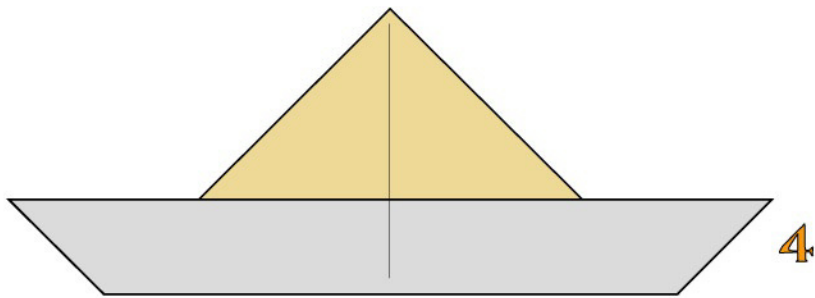

Modulo "D" ultimato

UNIONE DEI 1 MODULI

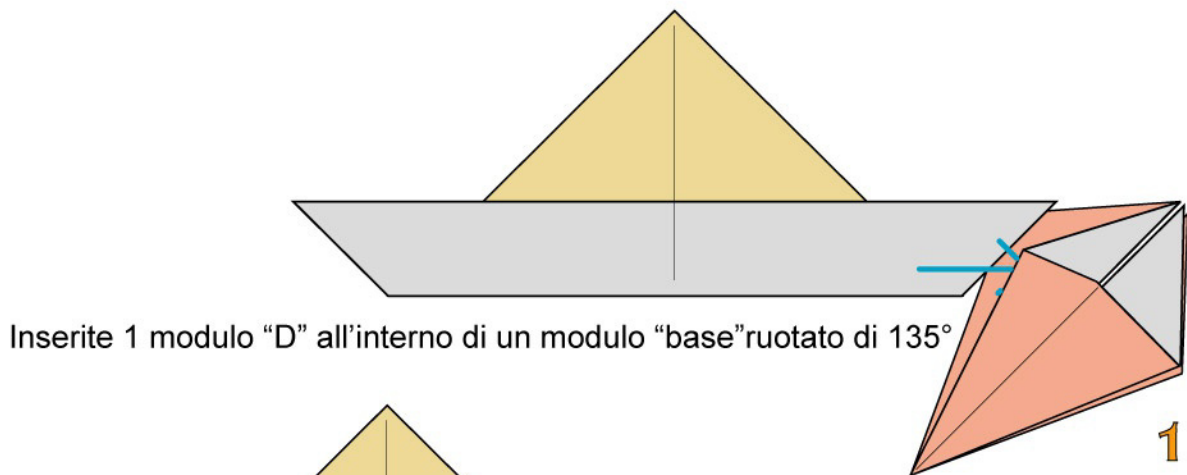

Inserite 1 modulo "D" all'interno di un modulo "base" ruotato di 135°

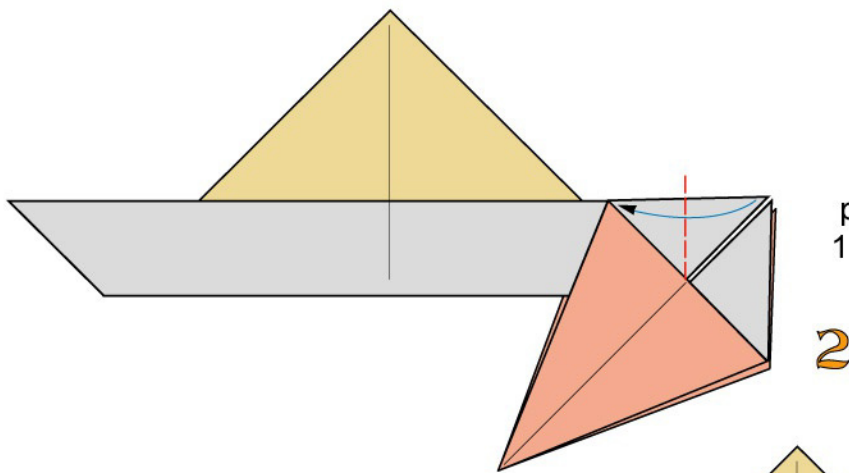

piegate ambedue i moduli con 1 piega a valle

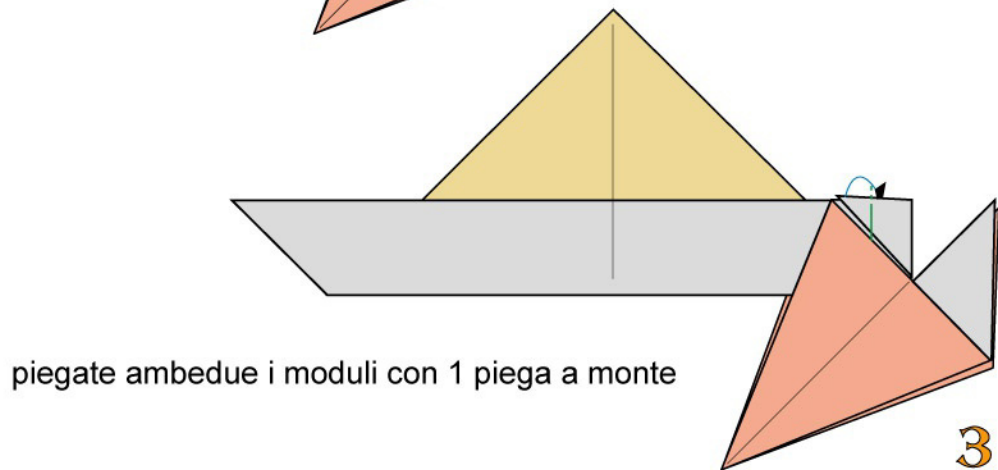

piegate ambedue i moduli con 1 piega a monte

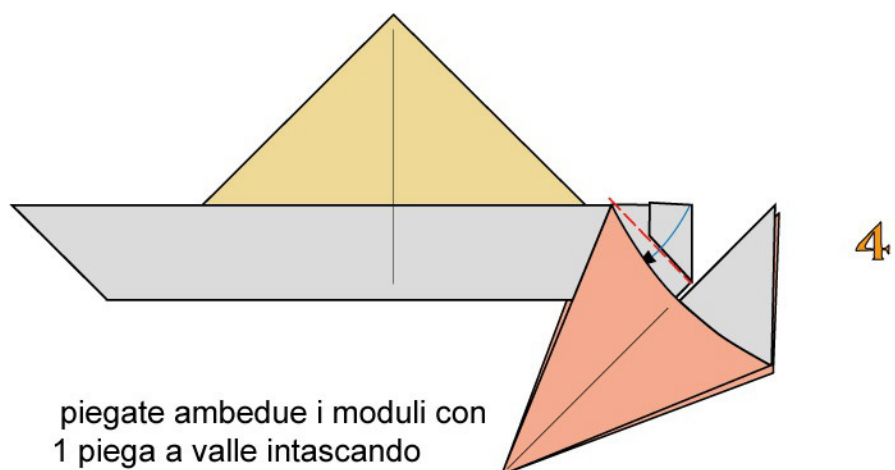

piegate ambedue i moduli con
1 piega a valle intascando

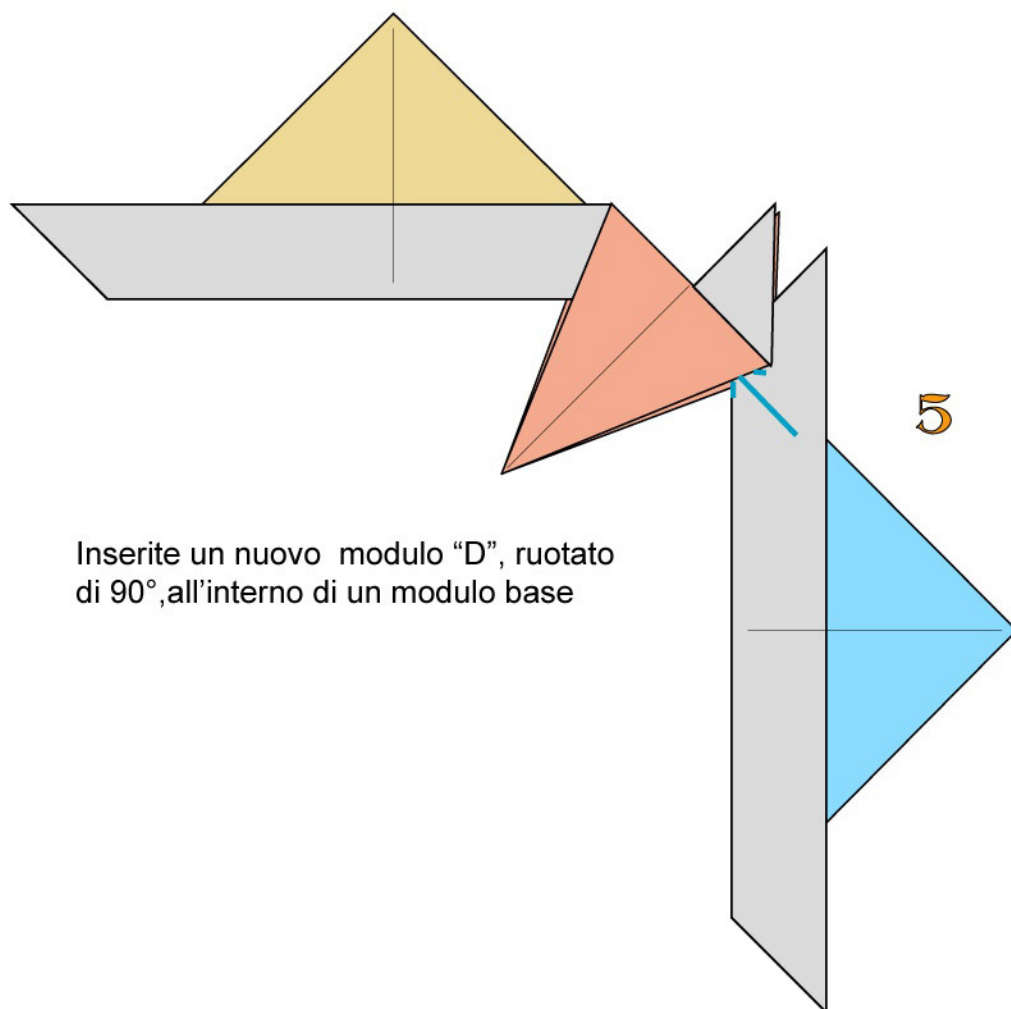

Inserite un nuovo modulo "D", ruotato
di 90°, all'interno di un modulo base

bloccate l'unione come
già visto nei passaggi precedenti

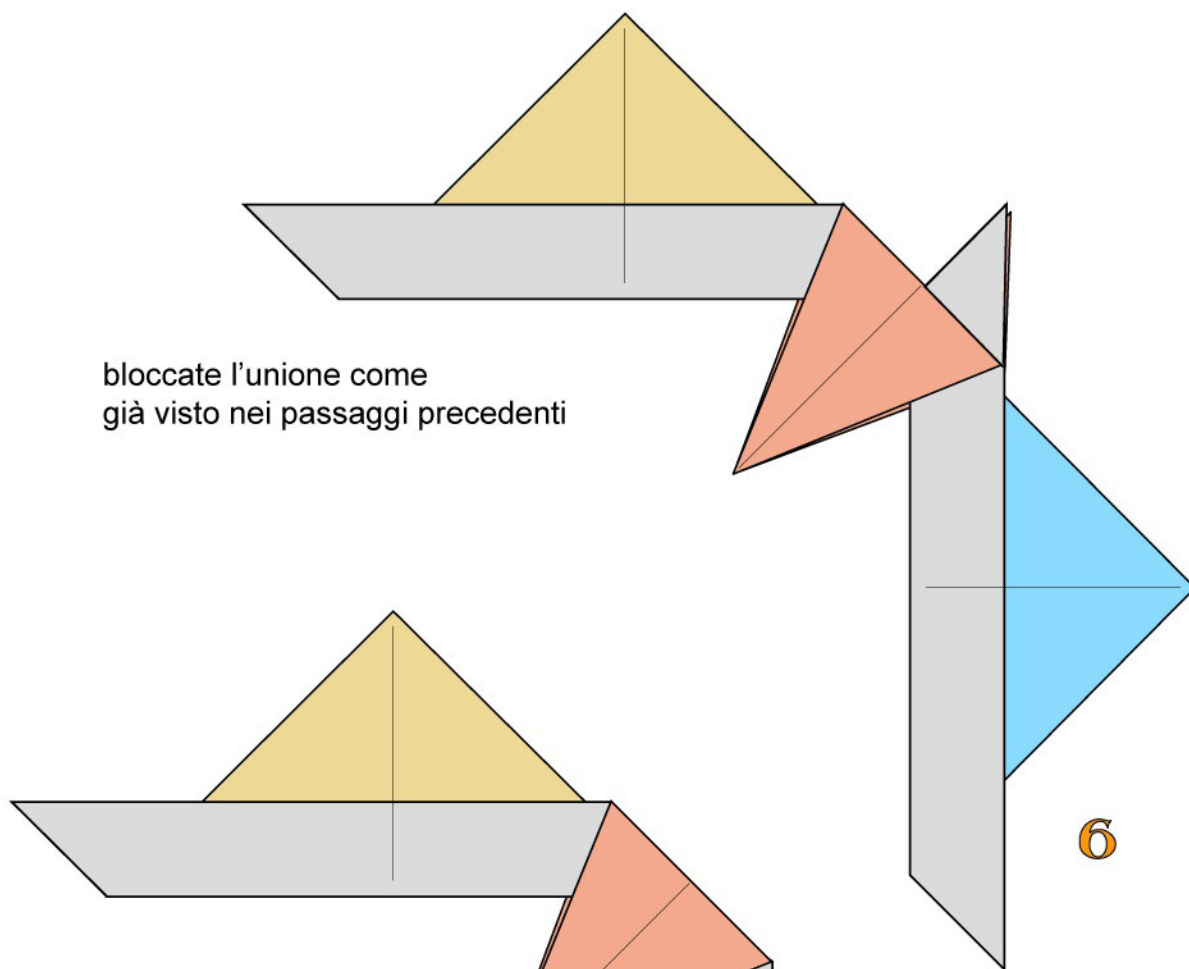

Inserite l'unione dei 3 moduli all'interno
di un nuovo modulo "base" ruotato di 225°

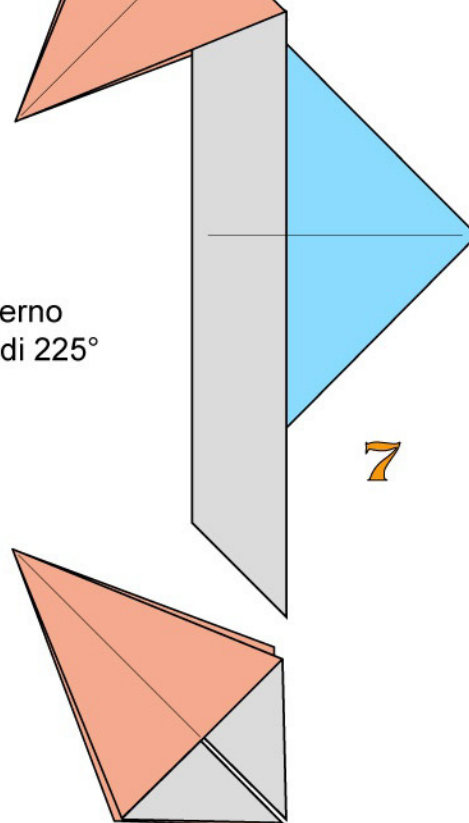

Girandola "A"

Questa girandola si realizza unendo 8 moduli uguali, da realizzare con carta monocolore o, meglio, bicolore

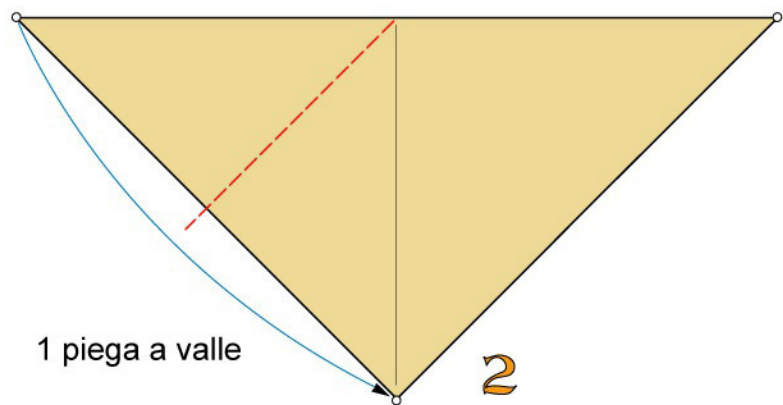
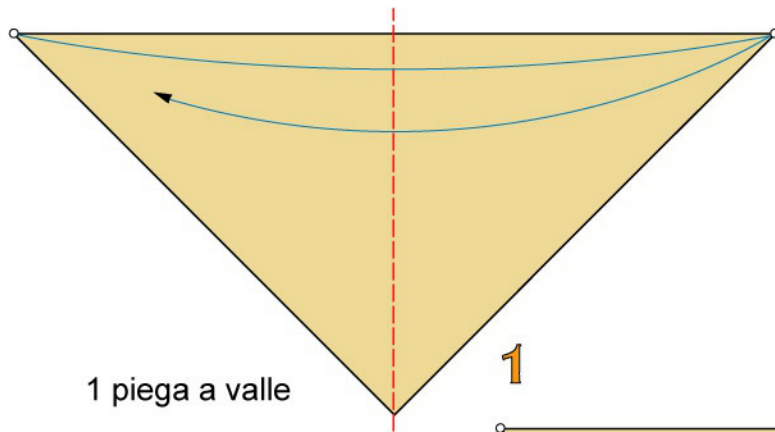
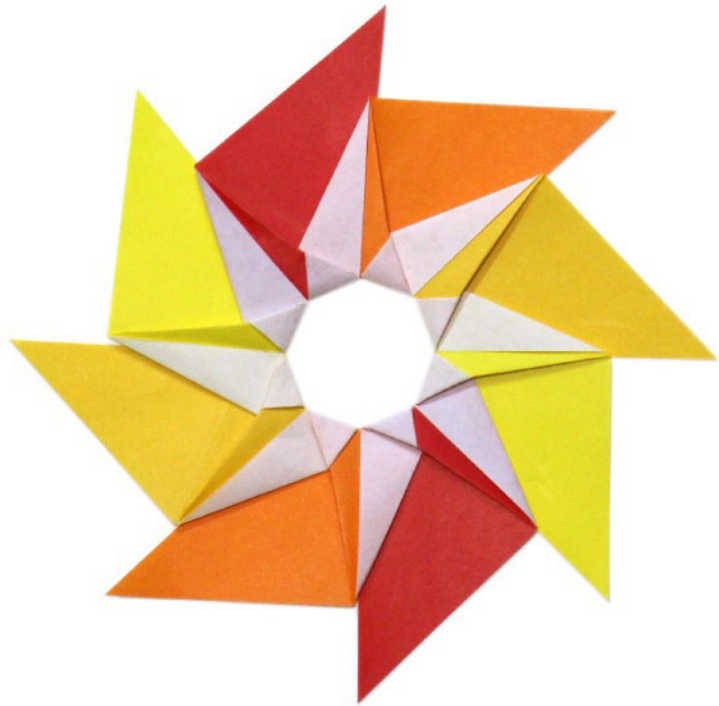

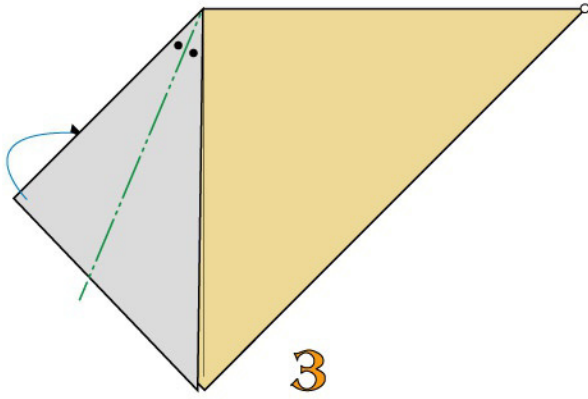

1 piega bisettrice a monte

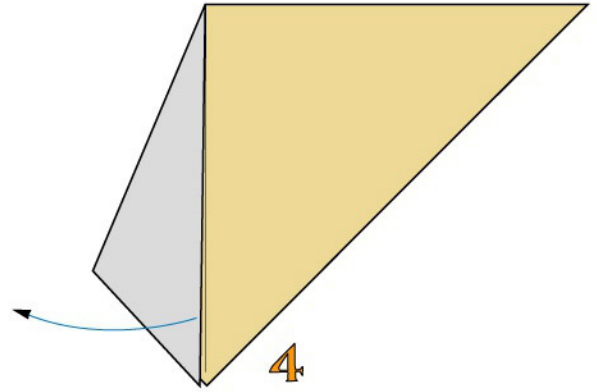

Riaprite

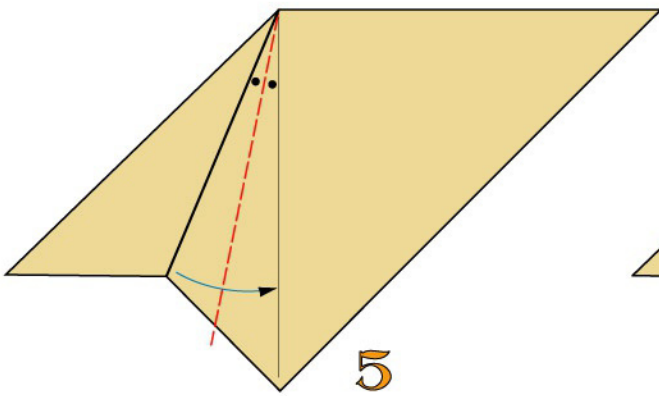

1 piega bisettrice a valle

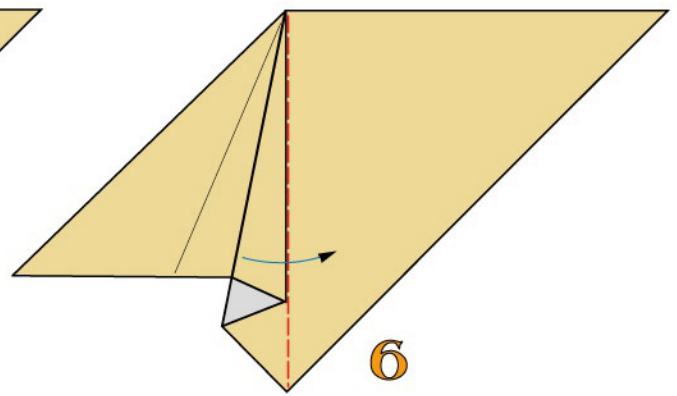

Ripiegate a valle

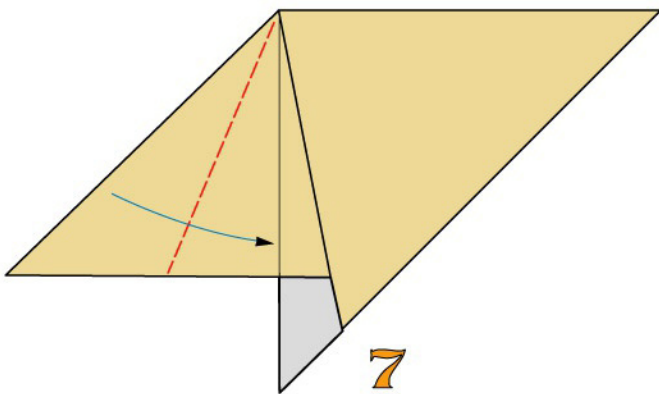

Ripiegate a valle

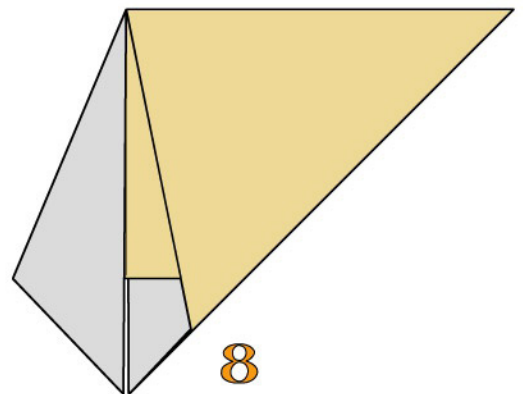

Modulo ultimato

UNIONE DEI MODULI

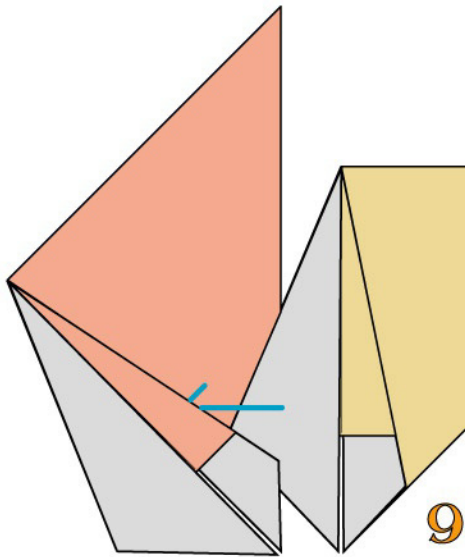

Inserite il modulo di destra entro il modulo di sinistra, ruotato di 45°

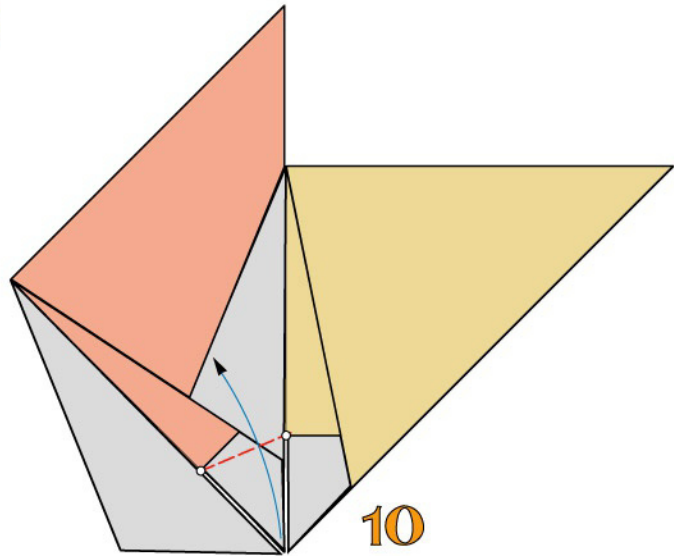

piegate ambedue i moduli con 1 piega a valle

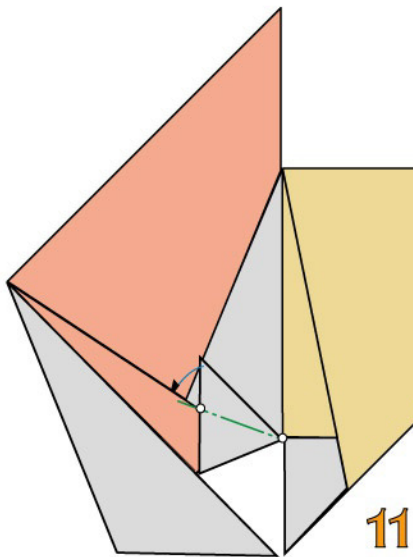

piegate ed intascate ambedue i moduli con 1 piega a monte

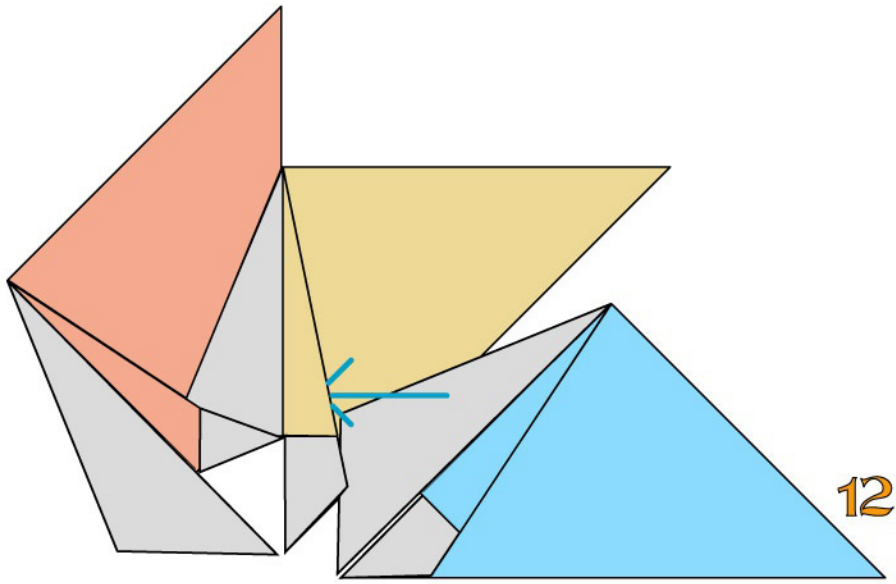

12

Inserite 1 nuovo modulo, ruotato di 90°

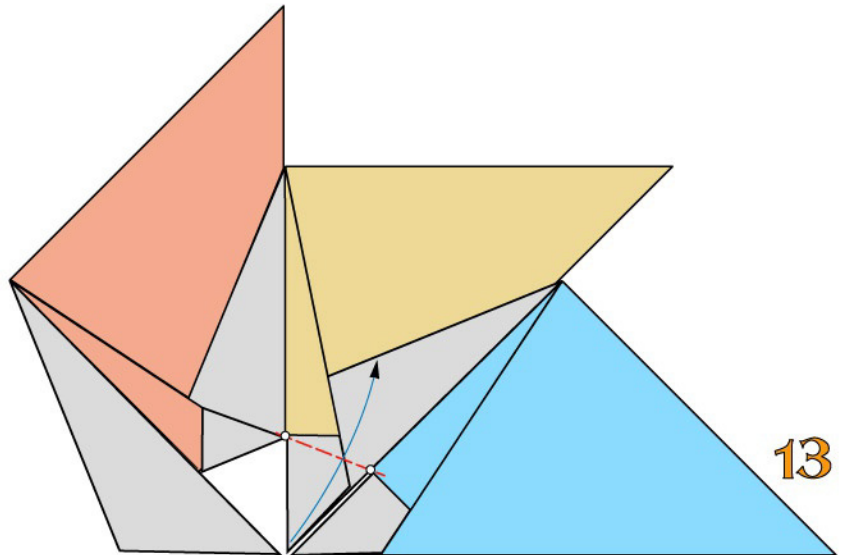

13

piegate ambedue i moduli
con 1 piega a valle

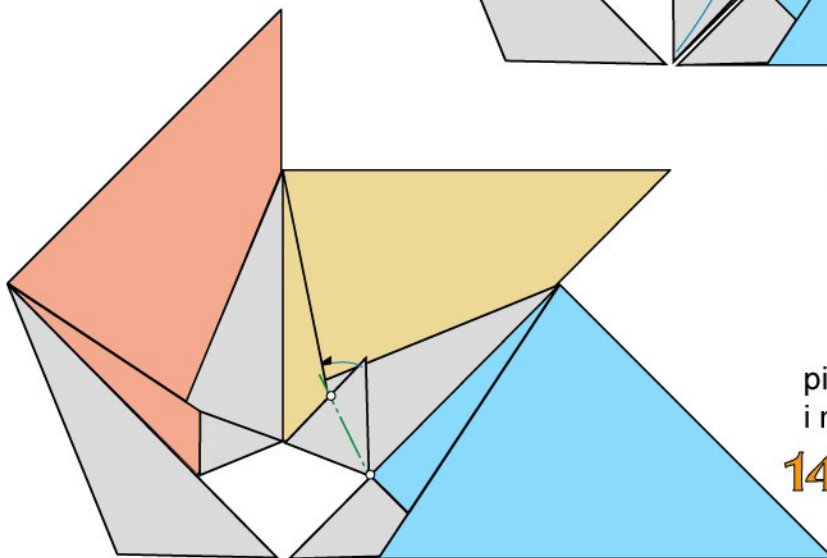

14

piegate ed intascate ambedue
i moduli con 1 piega a monte

Nastro "B"

Si realizza unendo un certo numero di moduli per formare una composizione modulare lineare. Adoperate carta preferibilmente bicolore

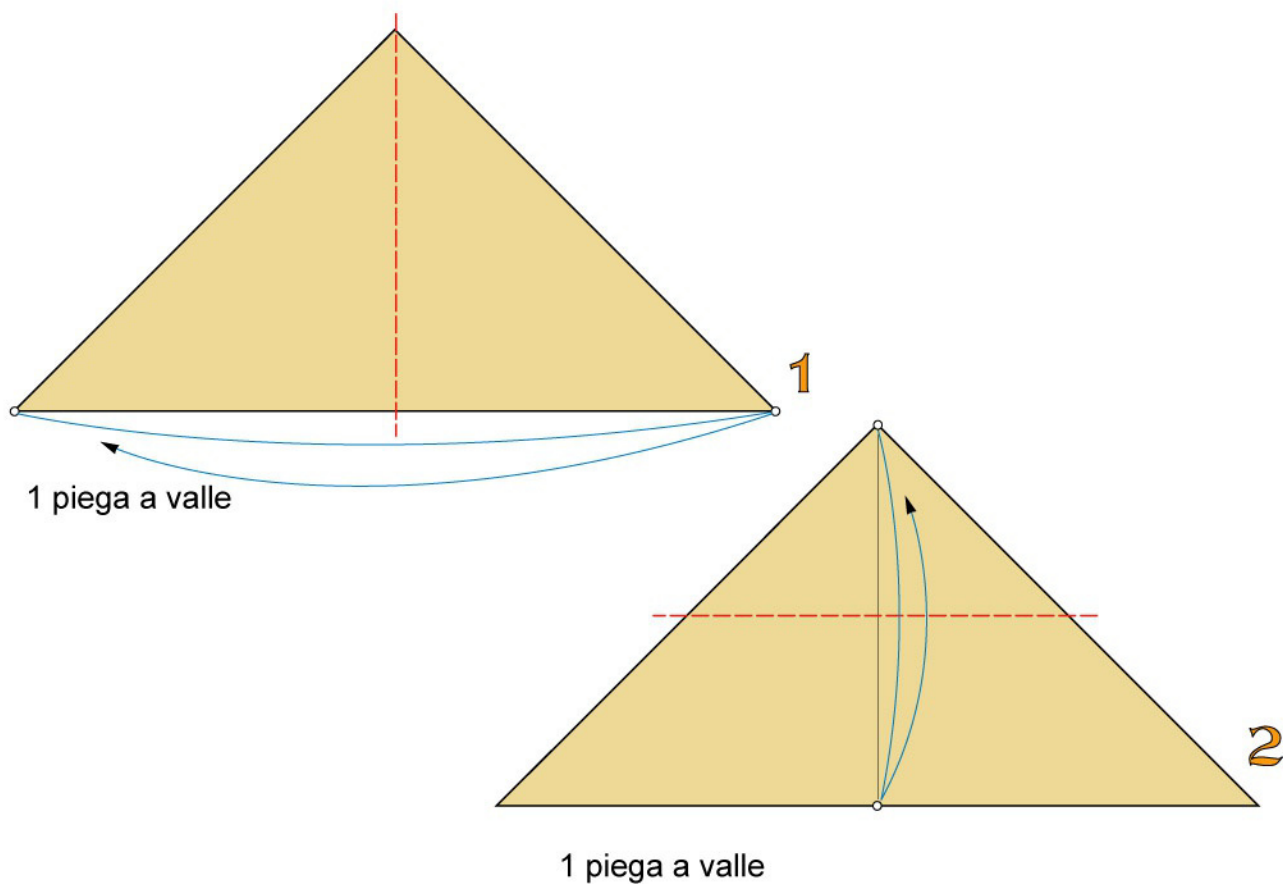
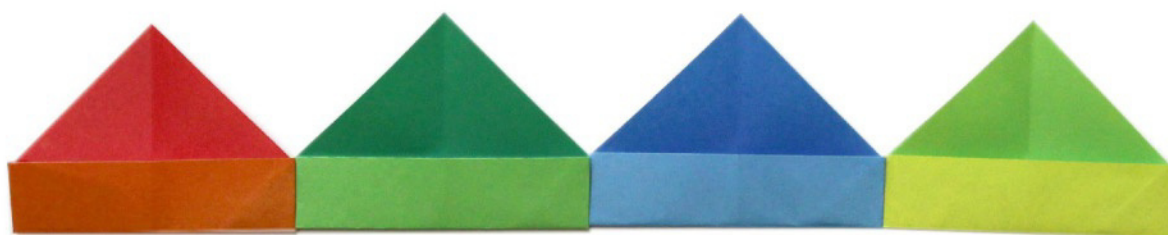

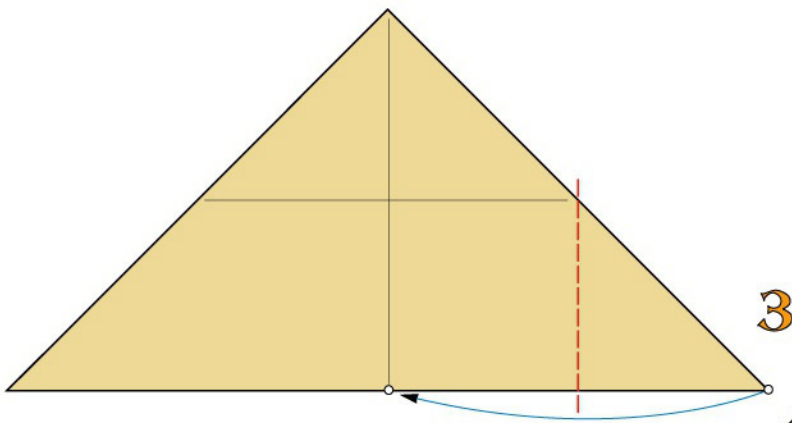

1 piega a valle

3

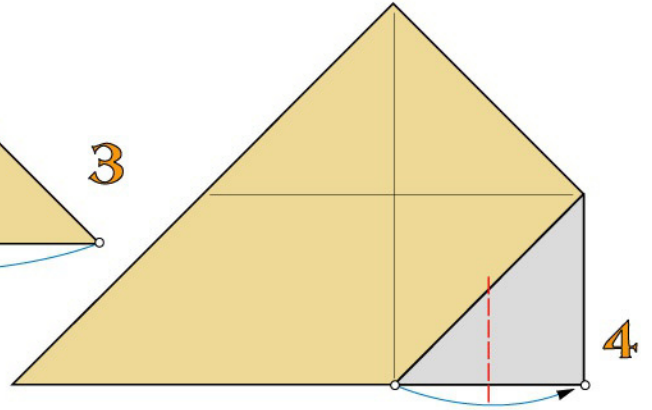

1 piega a valle

4

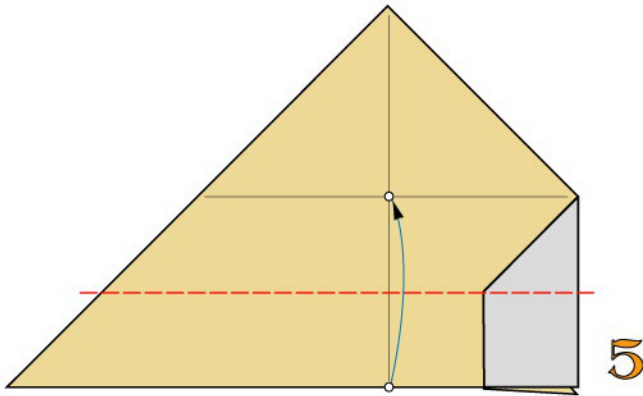

1 piega a valle

5

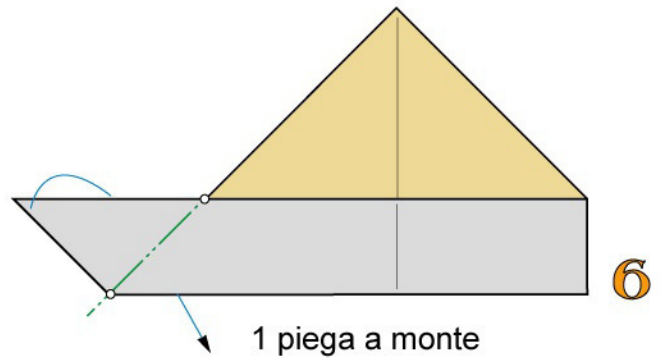

1 piega a monte

6

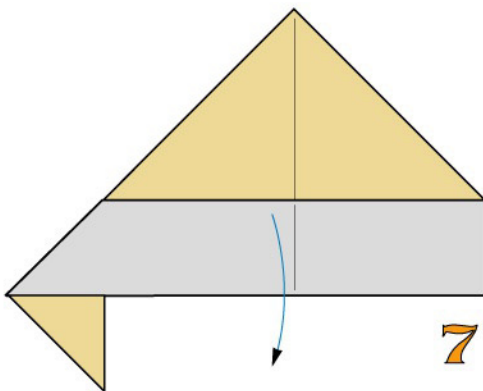

7

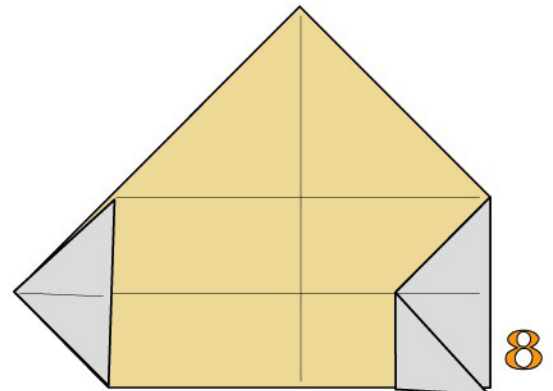

8

Modulo ultimato.
Riaprite per procedere al montaggio

UNIONE DEI MODULI

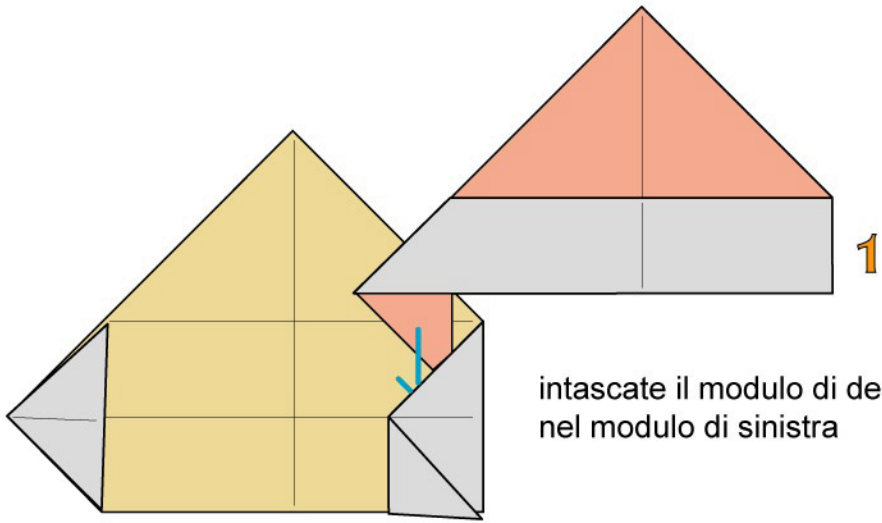

intascate il modulo di destra
nel modulo di sinistra

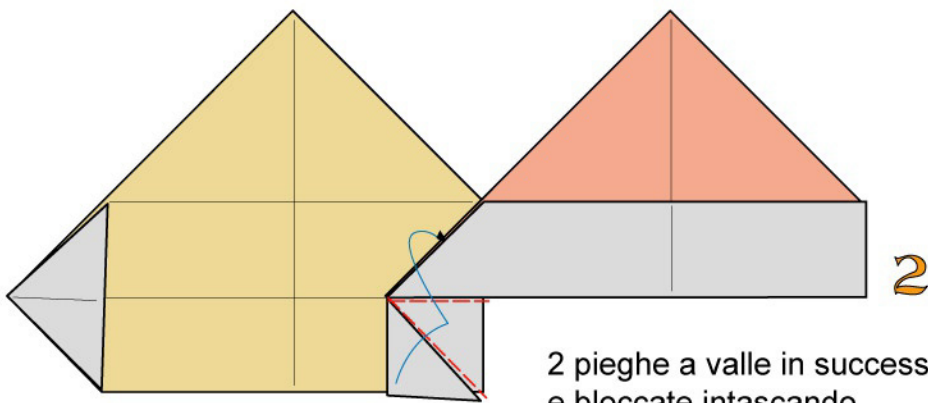

2 pieghe a valle in successione
e bloccate intascando

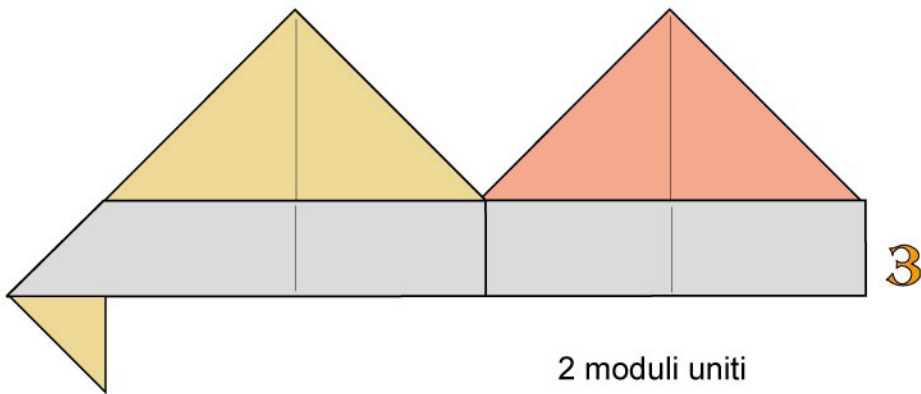

2 moduli uniti

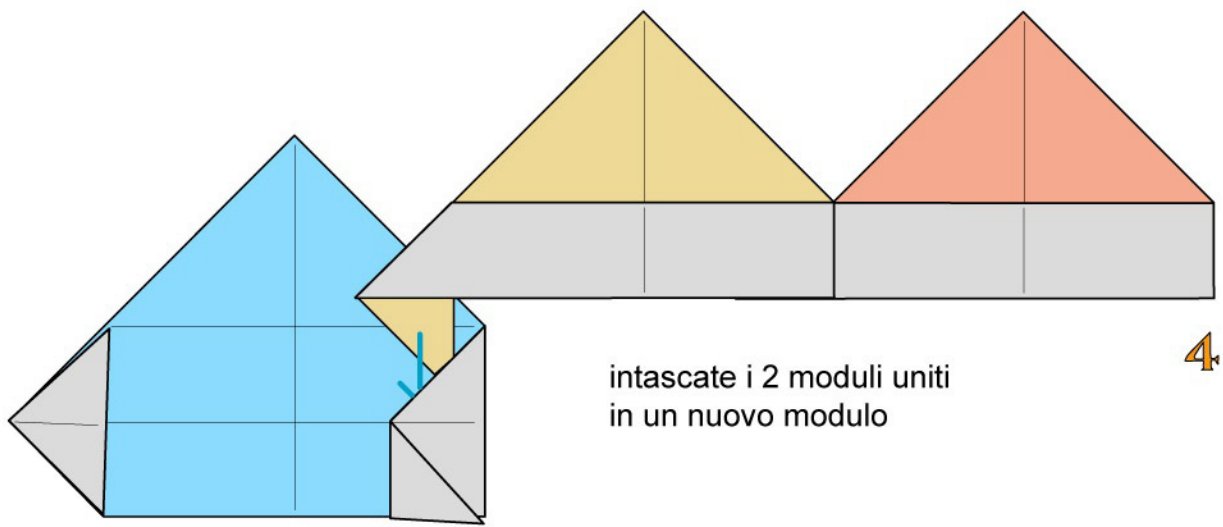

intascate i 2 moduli uniti
in un nuovo modulo

4

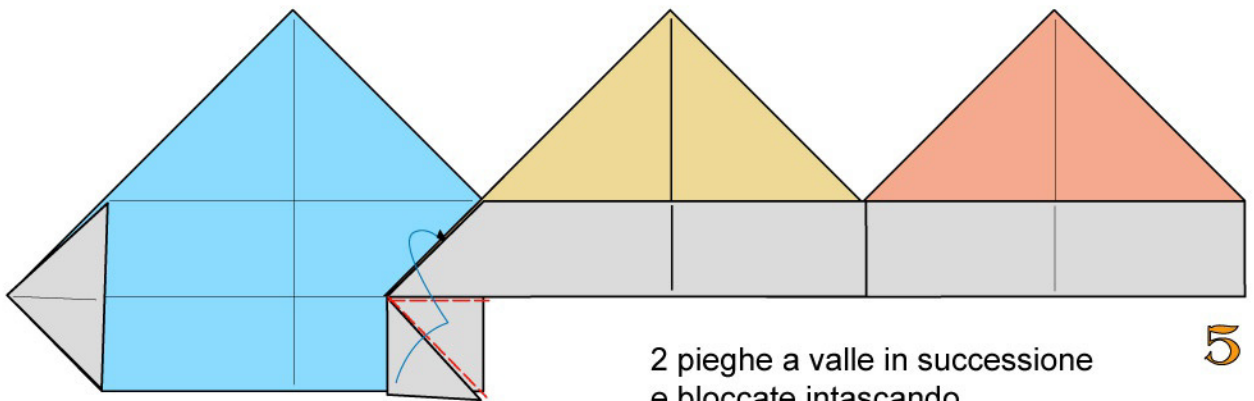

2 pieghe a valle in successione
e bloccate intascando

5

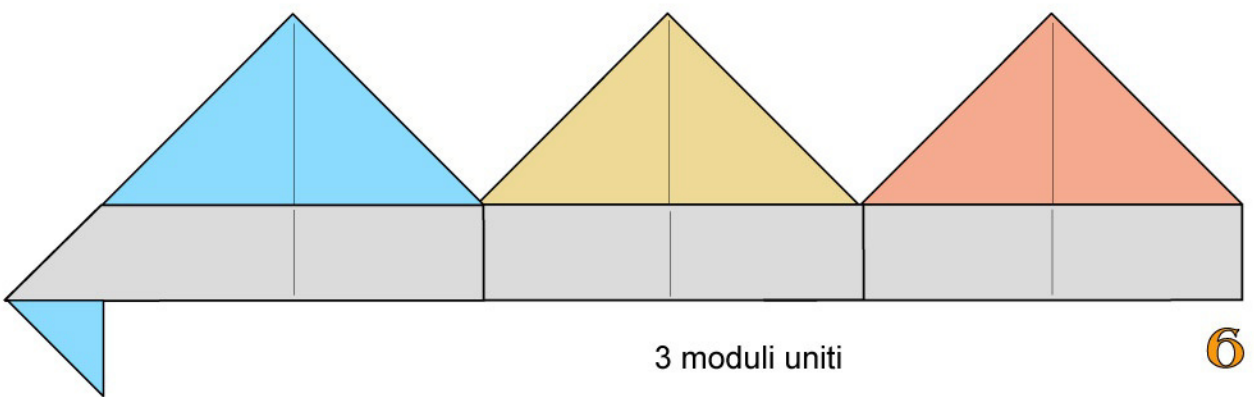

3 moduli uniti

6

Ghirlanda

Si possono realizzare decorazioni piatte con 8 moduli uguali, o 3D con 3,4,5,6,7 moduli. Nella foto di sinistra è evidente l'anello centrale convesso della ghirlanda realizzata con 6 moduli bicolori.

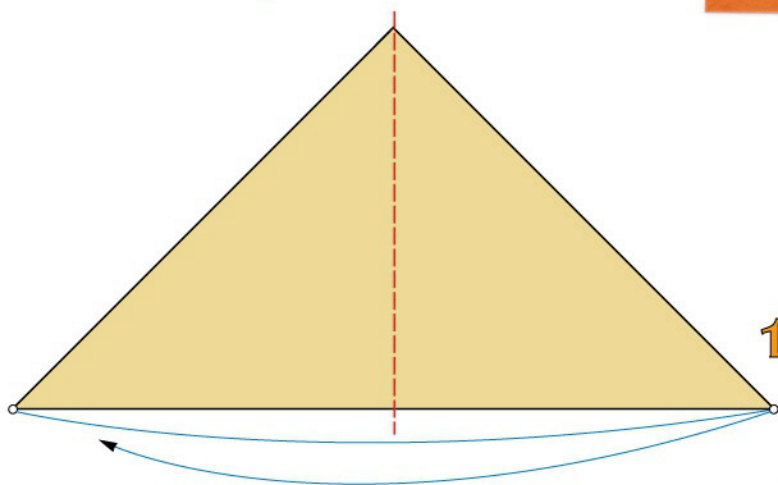
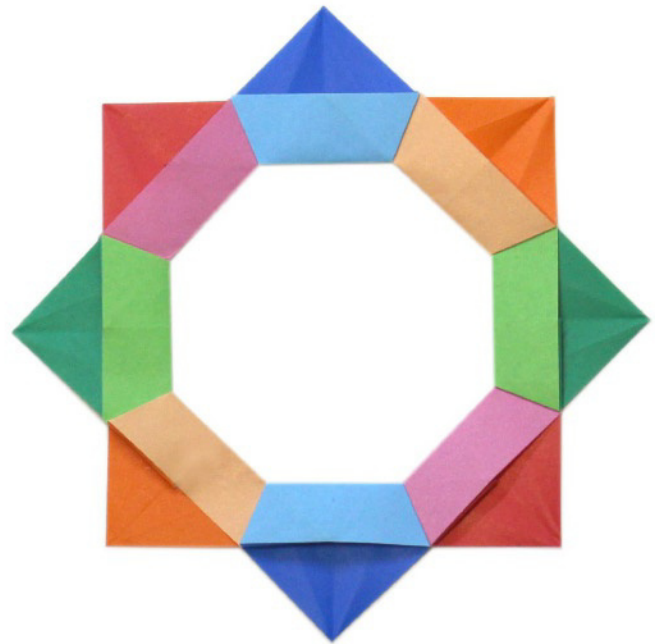
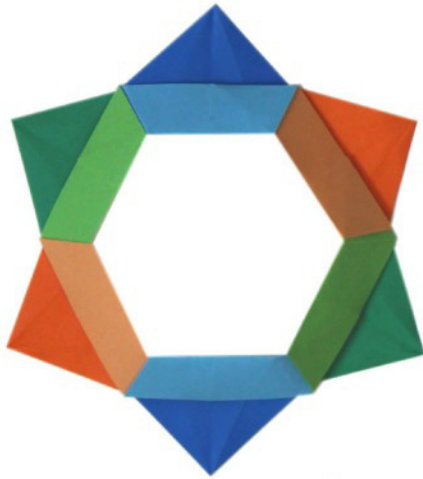

1 piega a valle

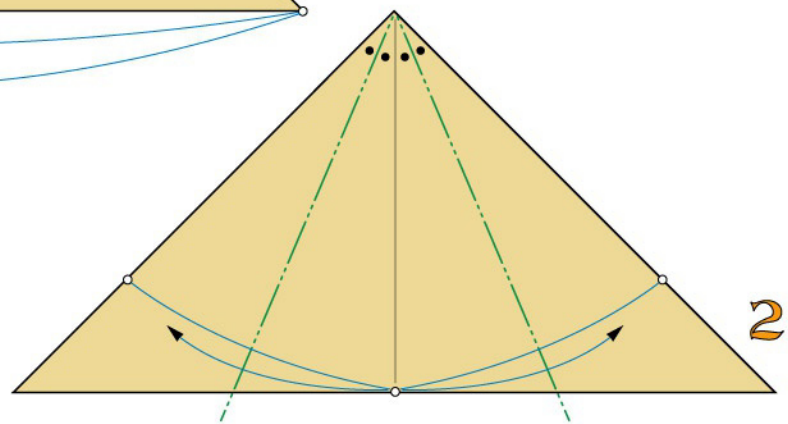

2 pieghe bisettrici a monte

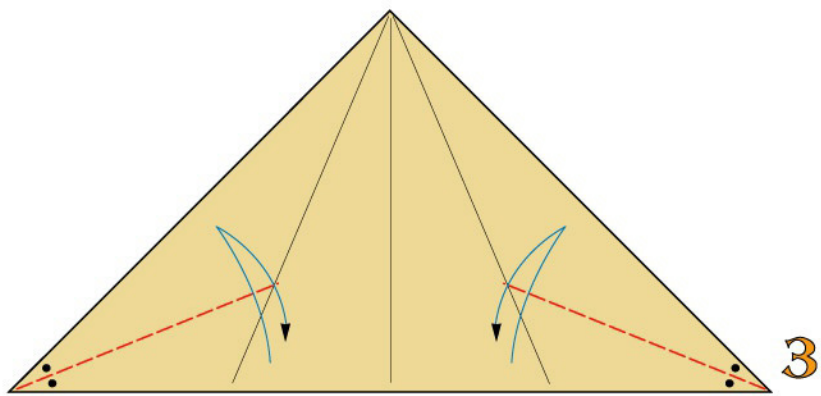

2 pieghe bisettrici a valle

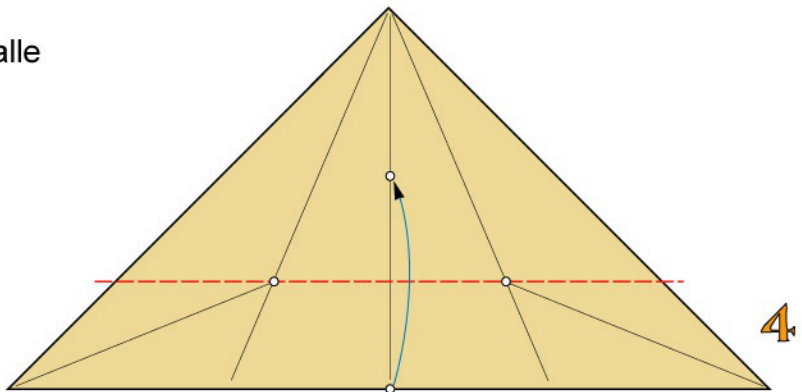

1 piega a valle

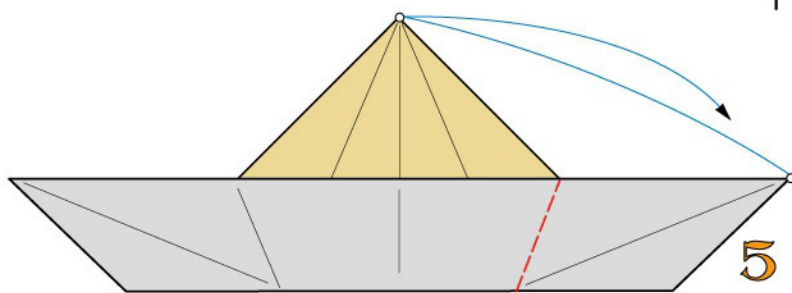

1 piega a valle

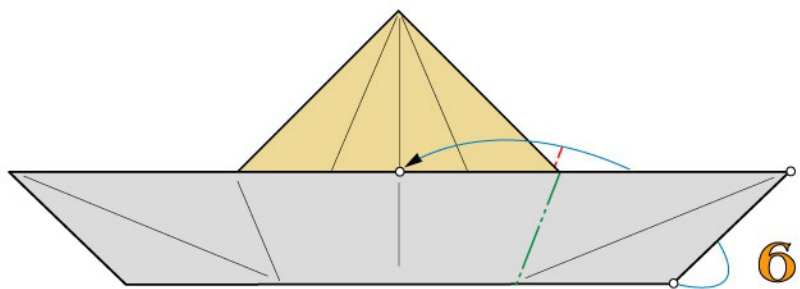

1 piega rovescia interna

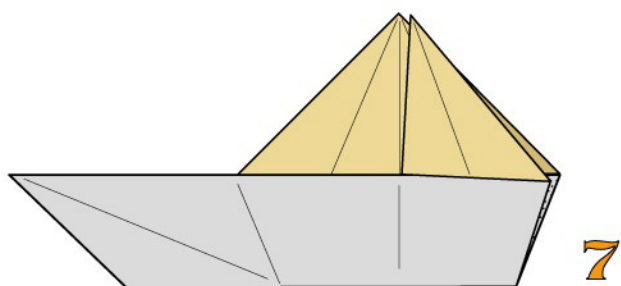

Modulo ultimato

UNIONE DEI MODULI

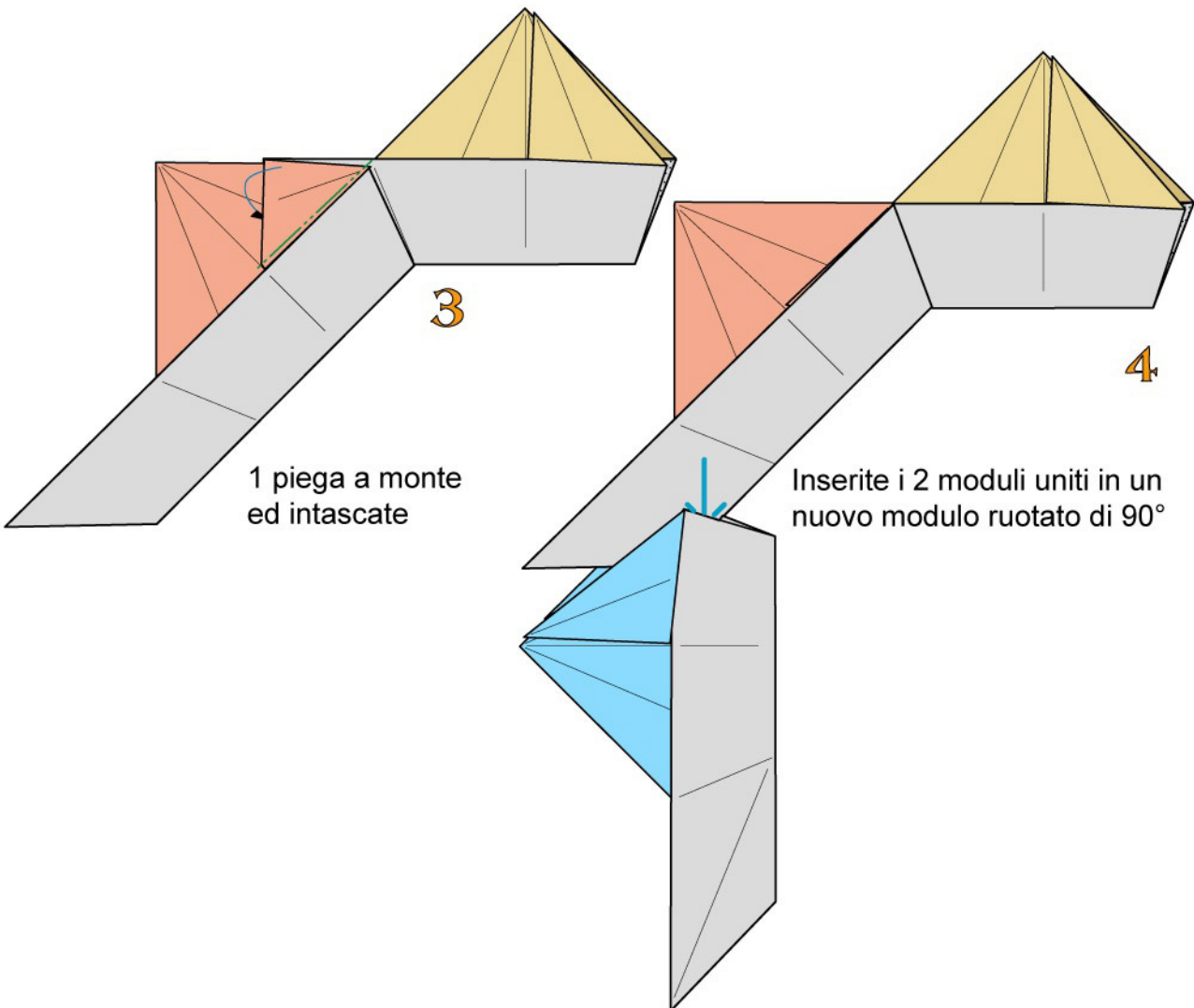
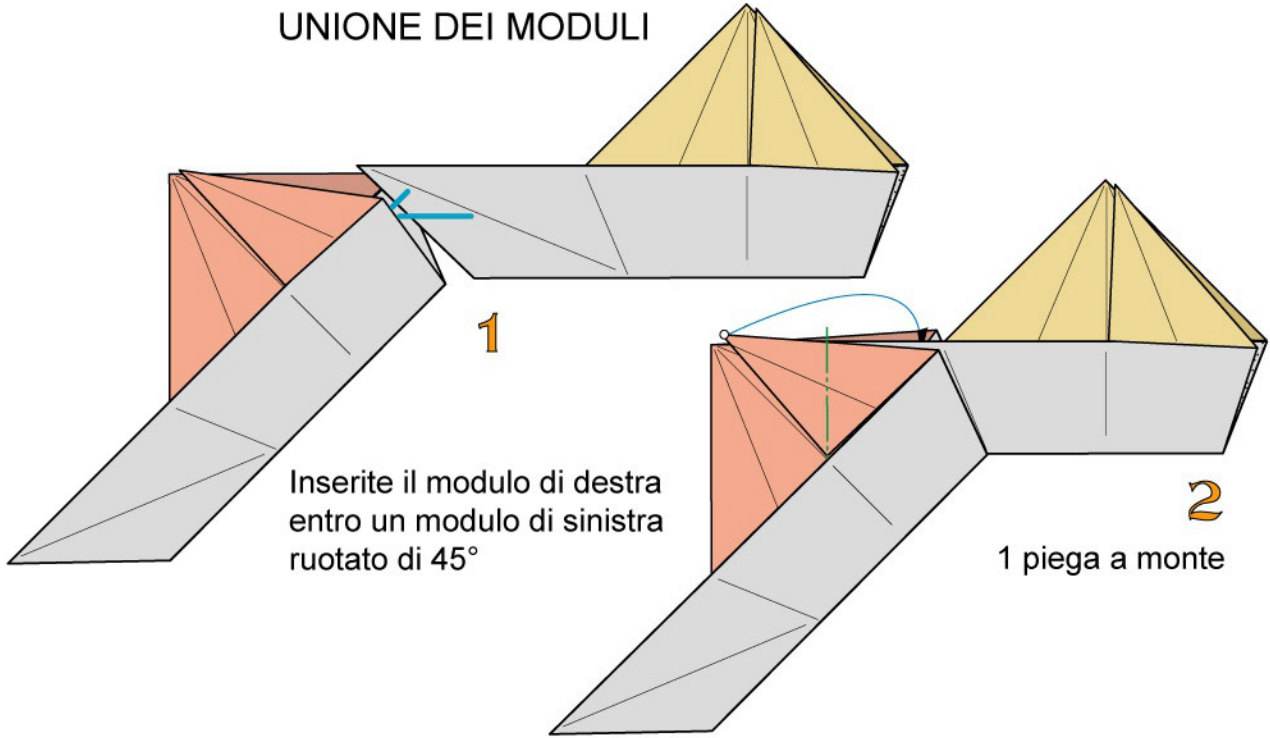

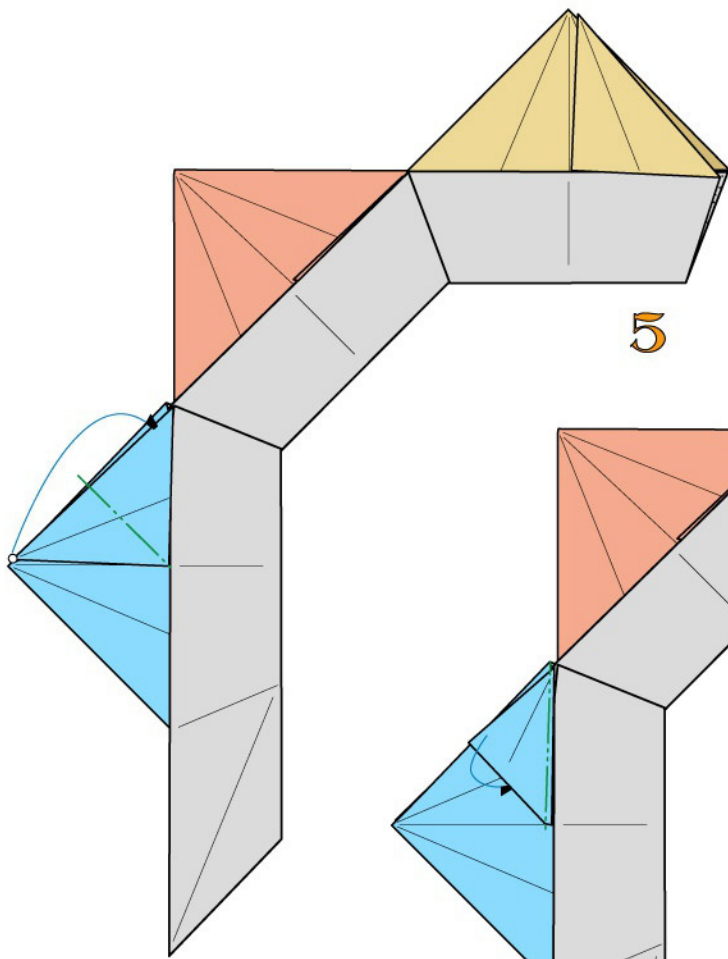

5

1 piega a monte

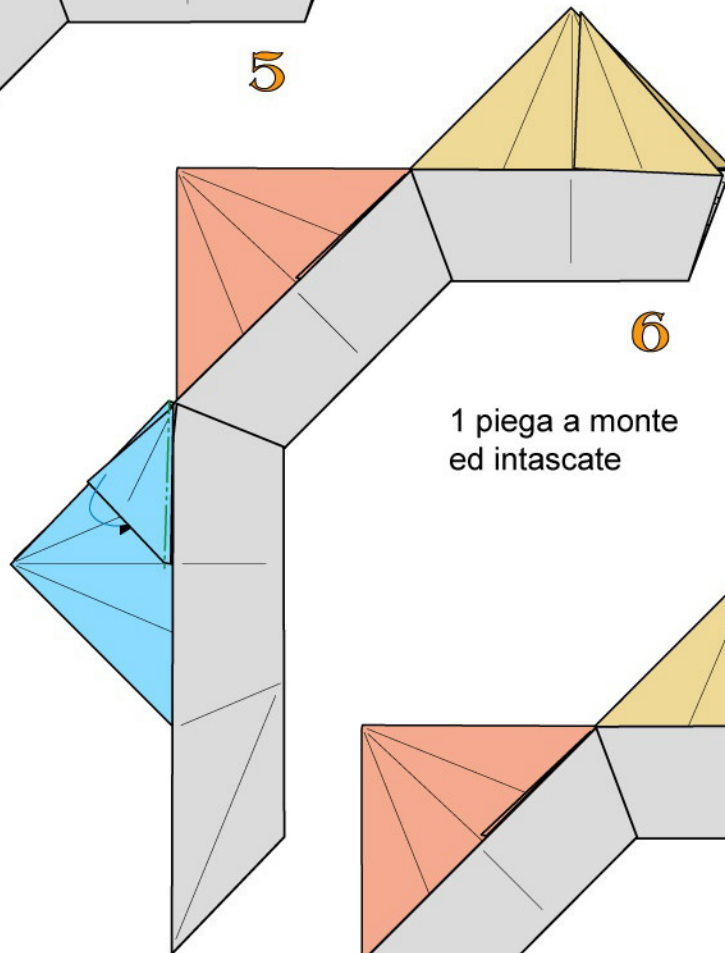

6

1 piega a monte
ed intascate

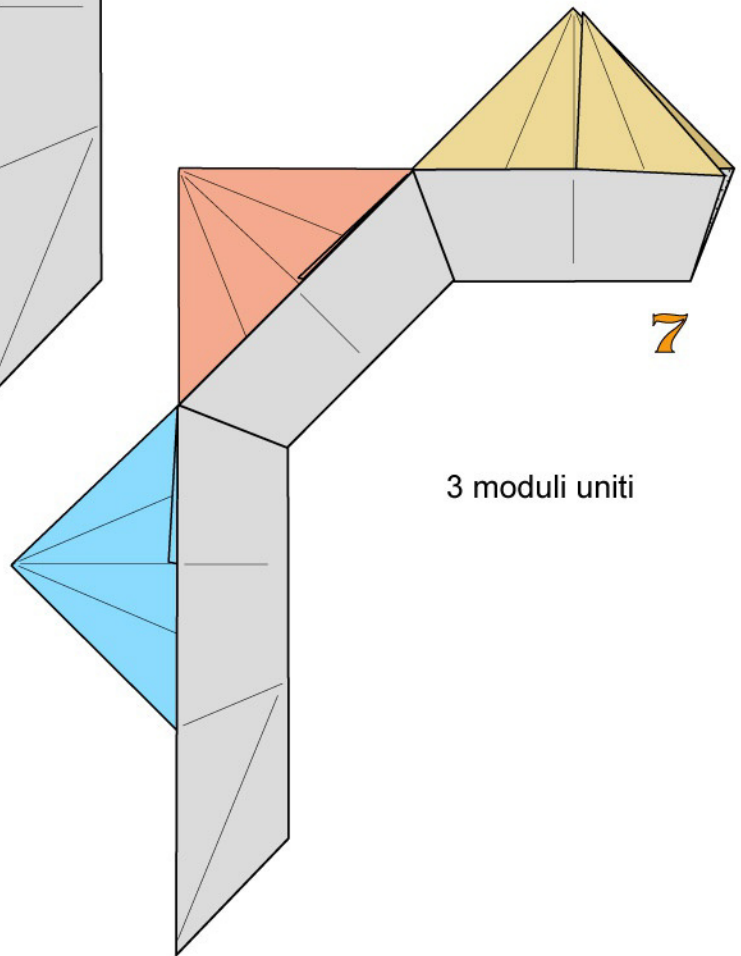

7

3 moduli uniti

Girandola "B"

Per la realizzazione di questa girandola sono necessari 8 moduli uguali costruiti con carta bicolore. Foto di fronte e retro

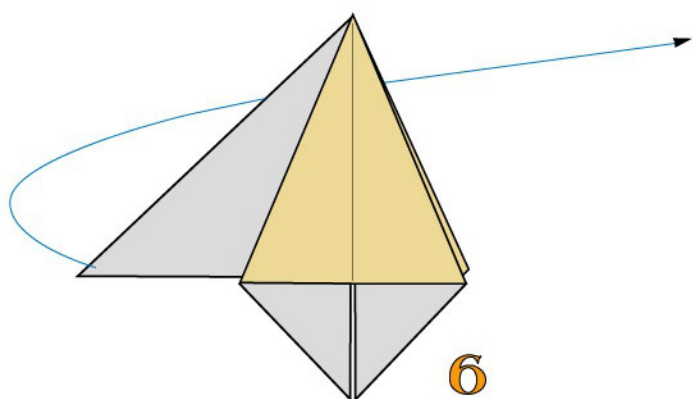
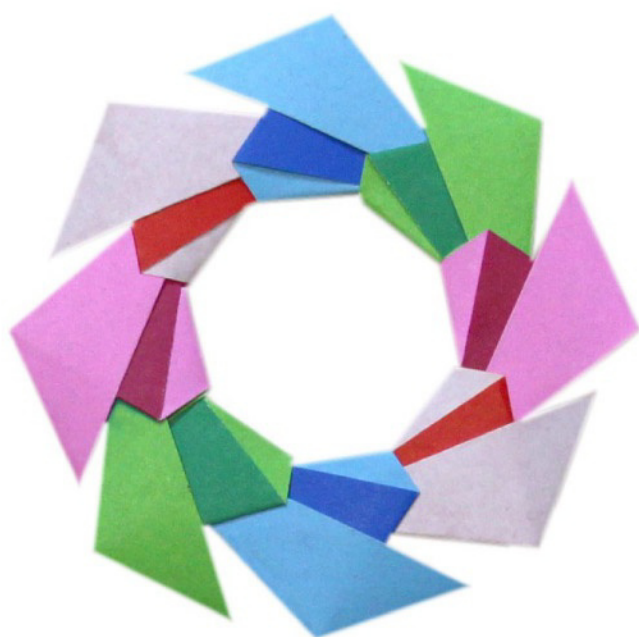

Partite dalla fig. n. 5 del modulo "A".
Aprite

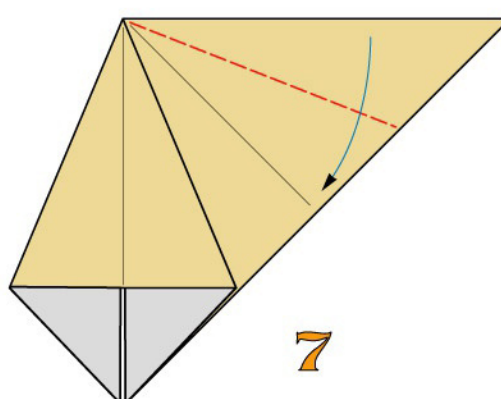

Ripiegate a valle

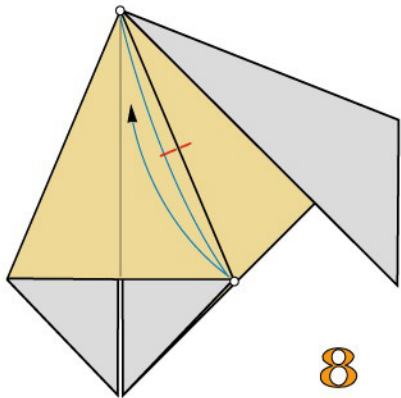

1 piccola piega a valle

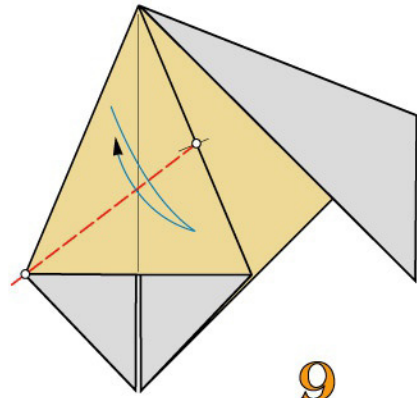

1 piega a valle

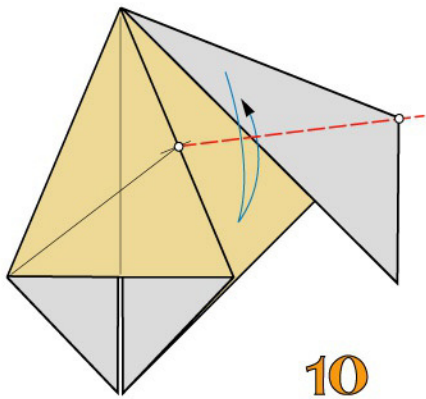

1 piega a valle

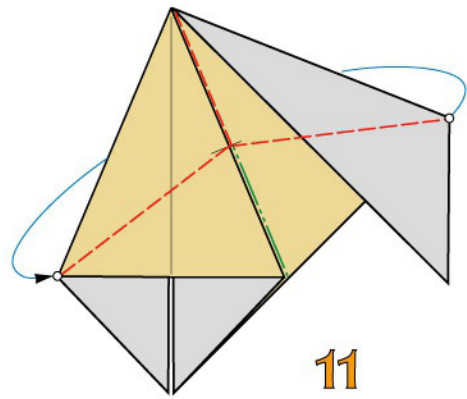

Ripiegando 3 volte a valle ed 1 a monte, eseguite una rovescia esterna

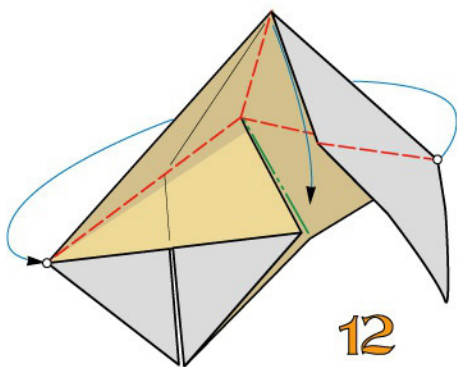

12

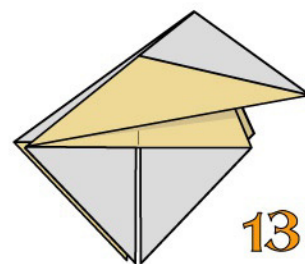

13

Modulo ultimato

UNIONE DEI MODULI

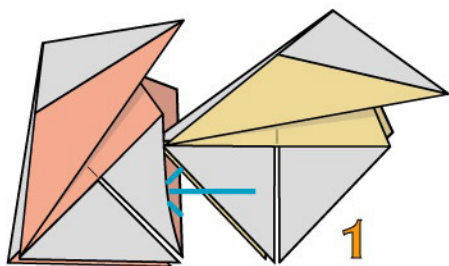

1

Inserite il modulo di destra entro il modulo di sinistra, ruotato di 45°

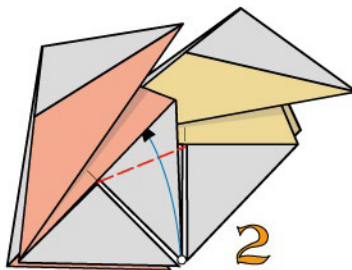

2

Piegate a valle ed intascate

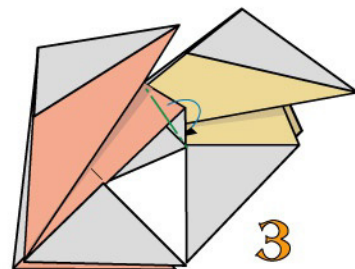

3

Piegate a monte ed intascate

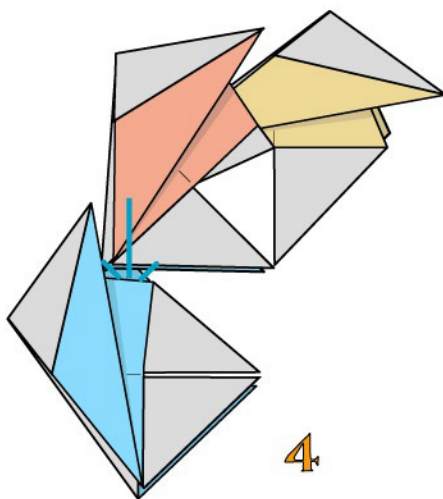

4

Inserite i 2 moduli uniti entro un nuovo modulo, ruotato di 90°

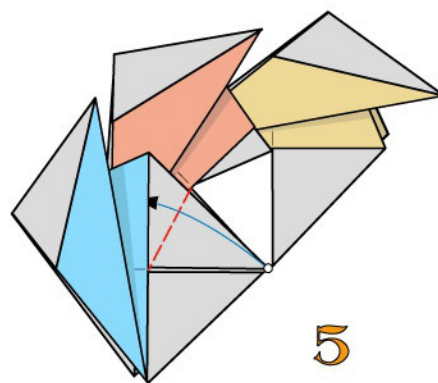

5

Una piega a valle ed intascate il vertice indicato

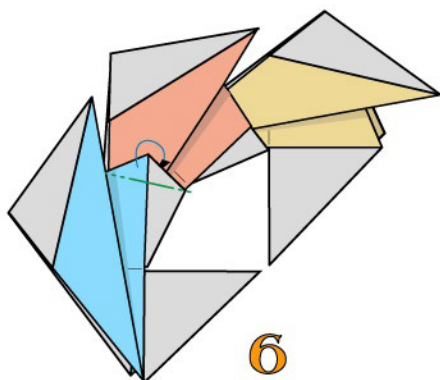

6

Una piega a valle ed intascate il vertice indicato

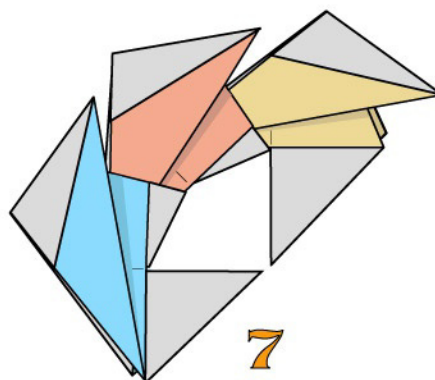

7

3 moduli uniti

GHIRLANDA "A"



Adoperate 4 fogli quadrati di carta monocoloro

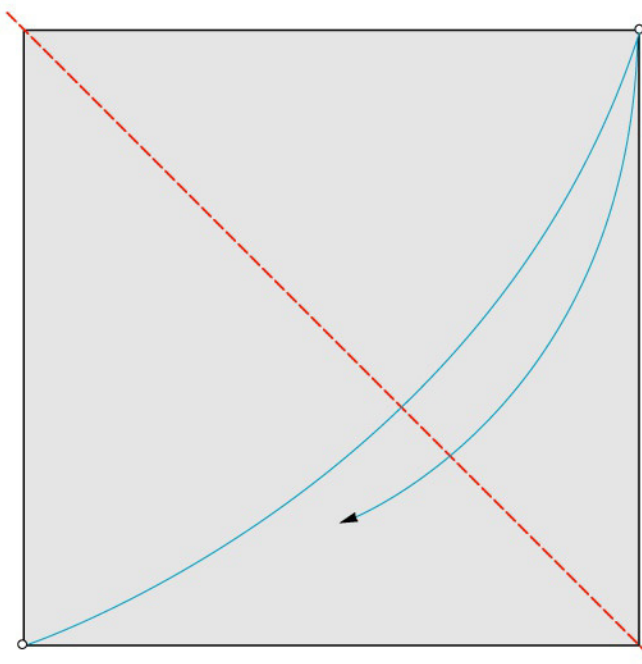

1 piega diagonale a valle

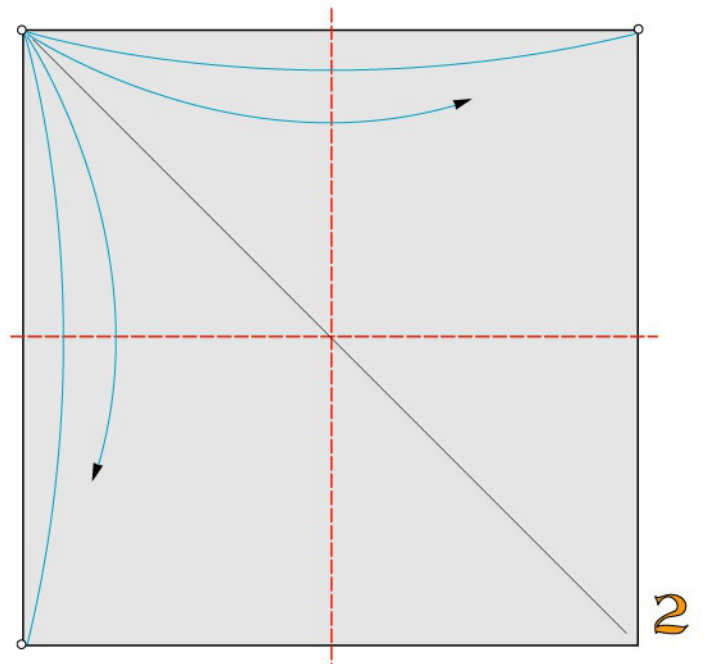

2 pieghe a valle

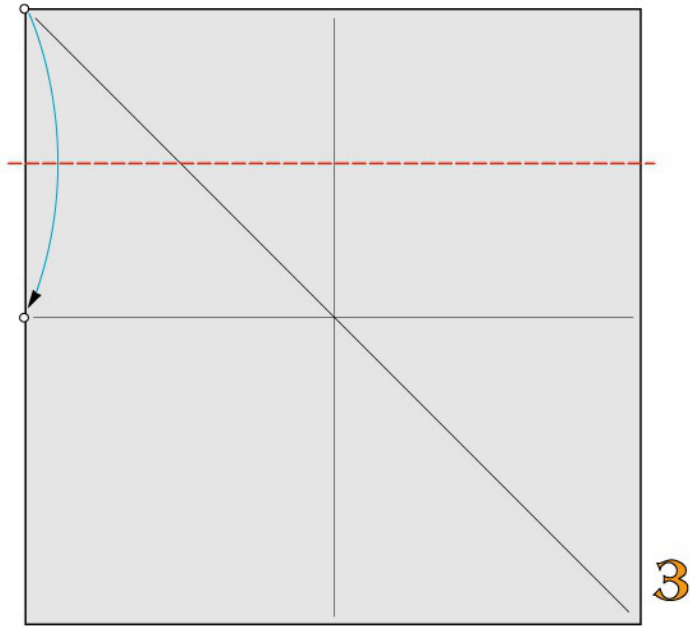

1 piega a valle

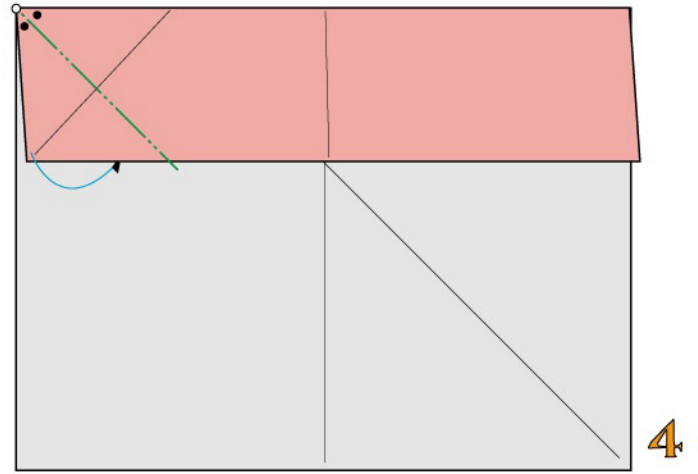

1 piega bisettrice a monte

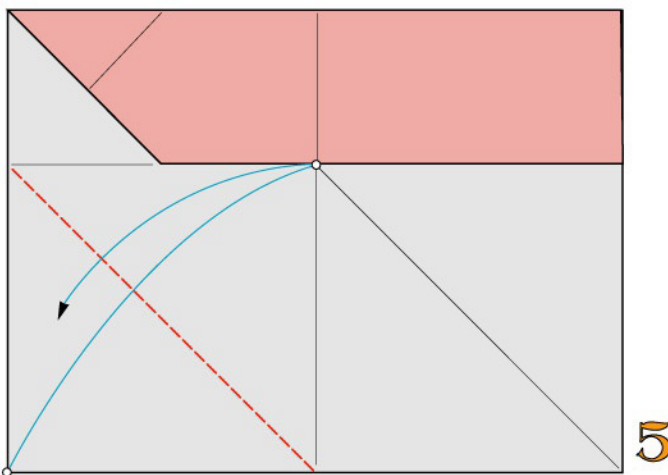

1 piega diagonale a valle

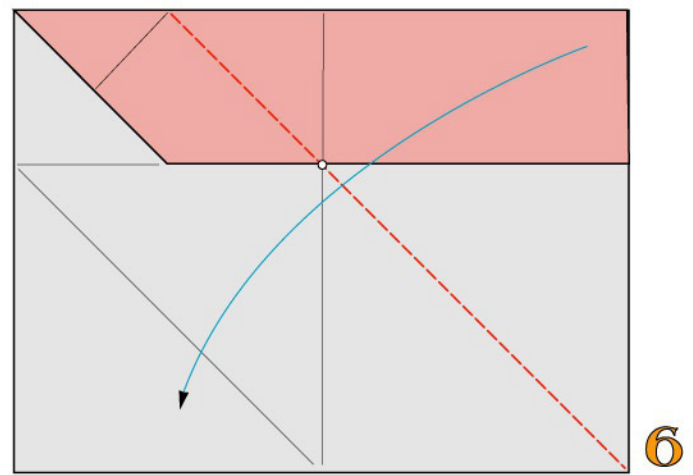

1 piega a valle

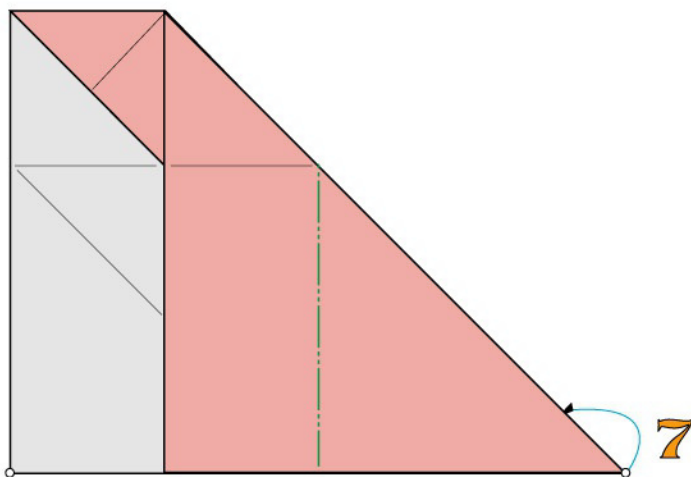

1 piega a monte

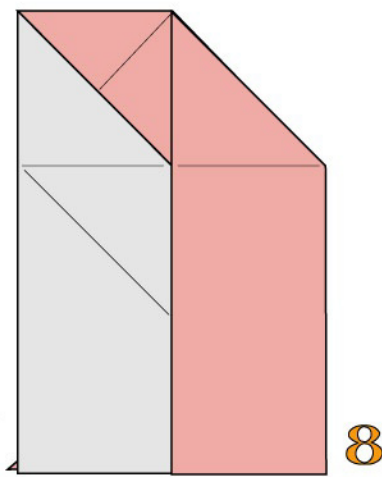

Modulo ultimato

UNIONE DEI MODULI

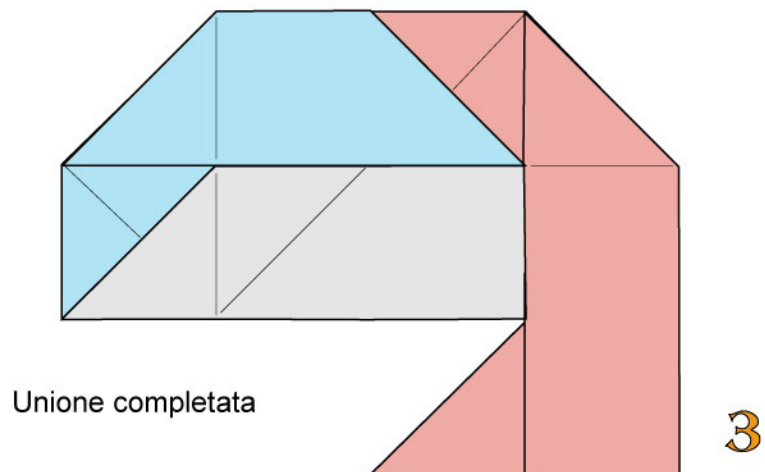
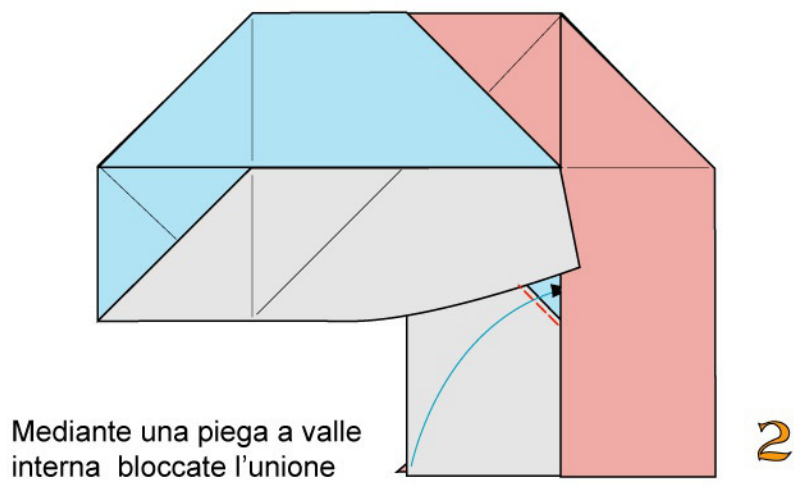
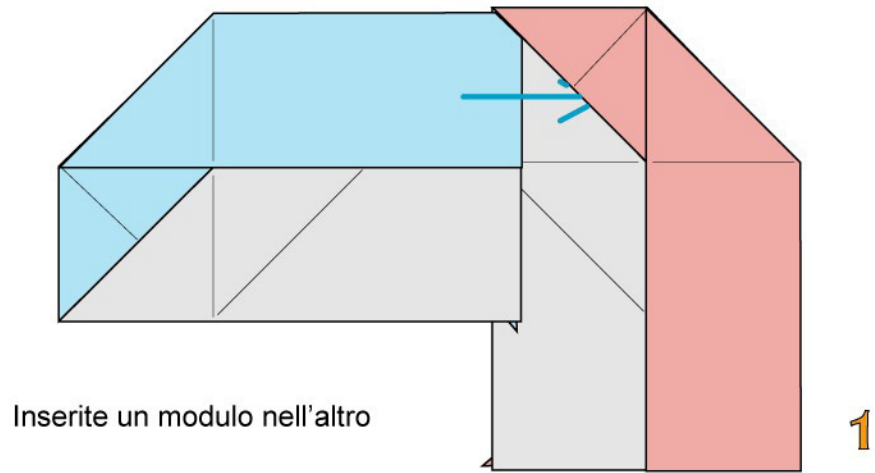

GHIRLANDA "B"

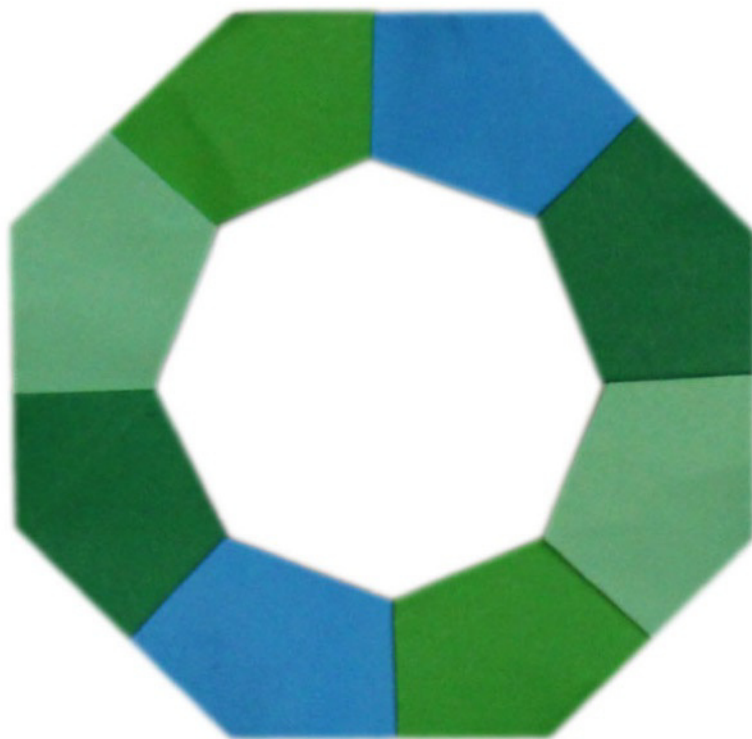

Adoperate 8 fogli quadrati di carta monocoloro o bicolore

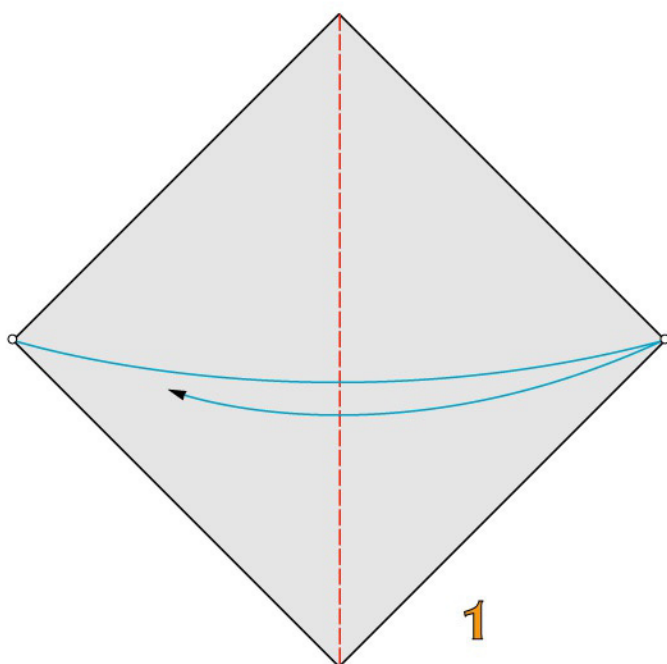

1

1 piega diagonale a valle

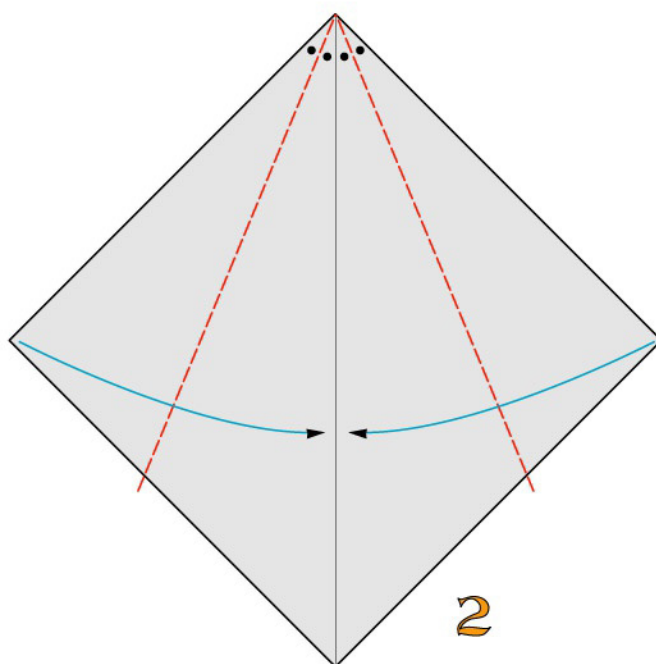

2

2 pieghe bisettrici a valle

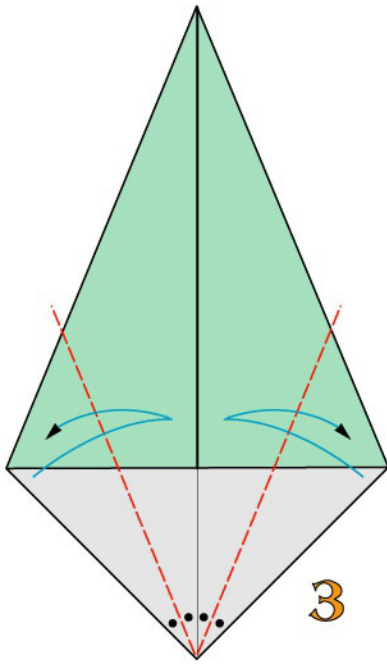

2 pieghe bisettrici a valle

3

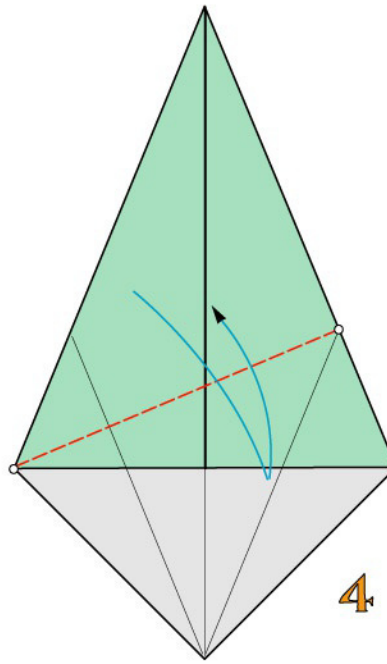

1 piega a valle

4

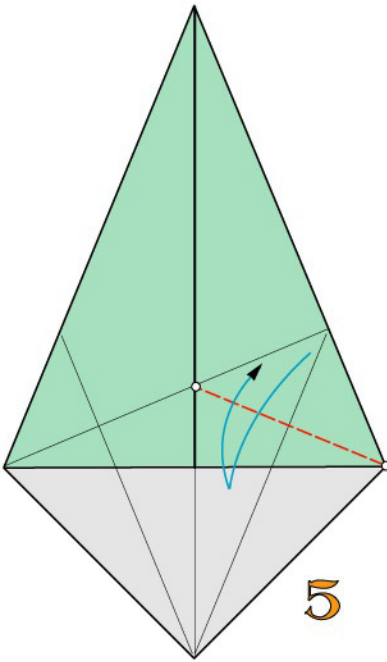

1 piega a valle

5

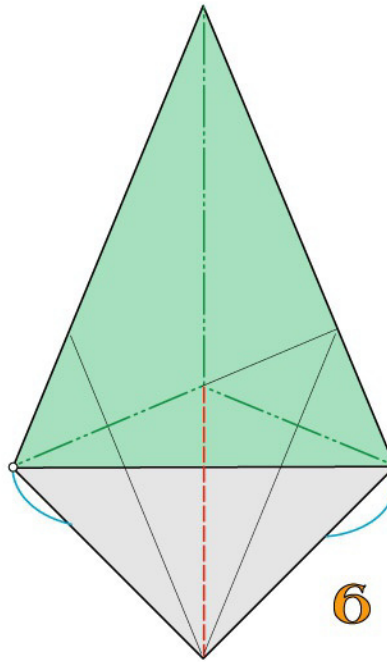

Ripiegate a valle e a monte

6

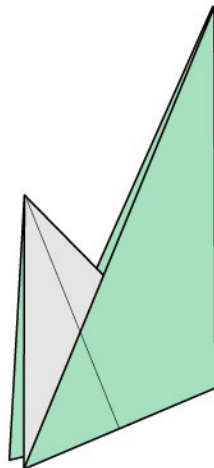

Modulo ultimato

7

UNIONE DEI MODULI

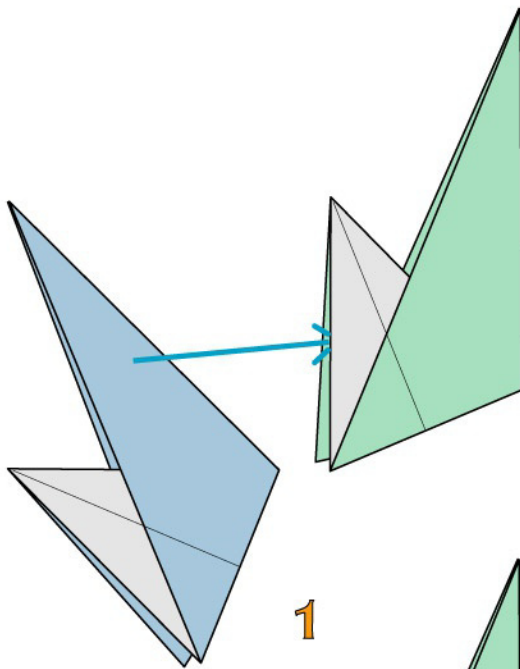

Inserite un modulo nell'altro

1

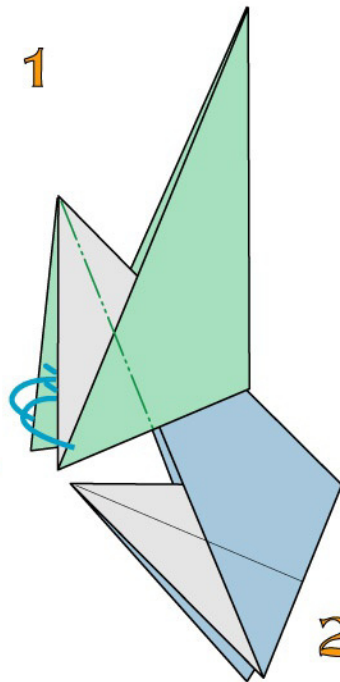

2 pieghe a monte, 1 per lato e intascate

2

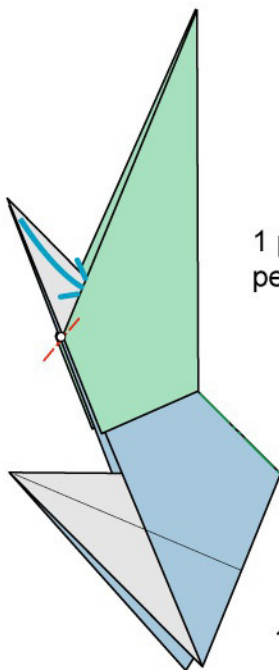

1 piega a valle interna per bloccare l'unione

3

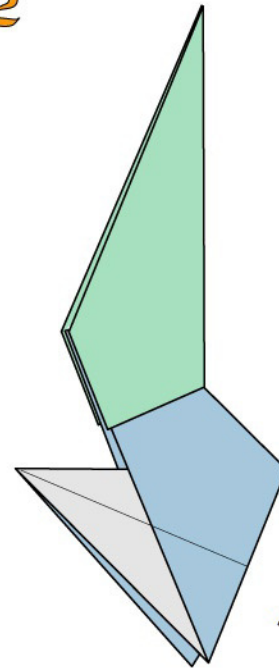

Unione completata

4

GHIRLANDA "C"

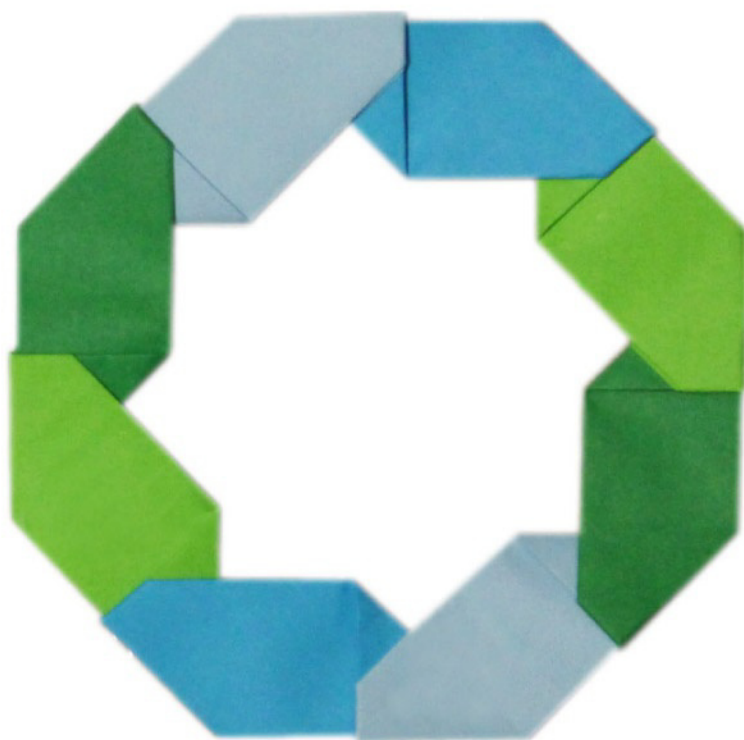

Adoperate 8 fogli A4 o frazioni di A4, monocolori o bicolori

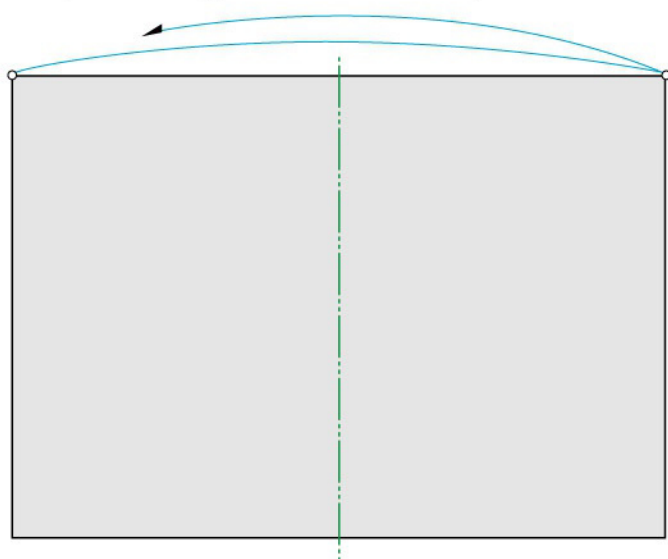

1 piega a monte

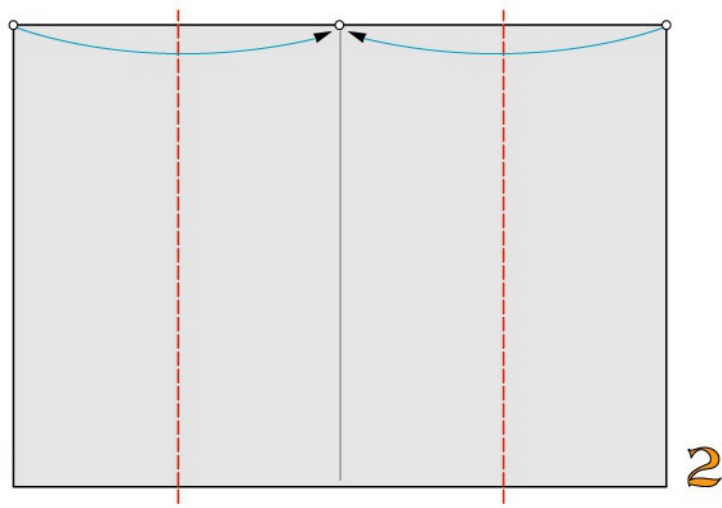

2 pieghe a valle

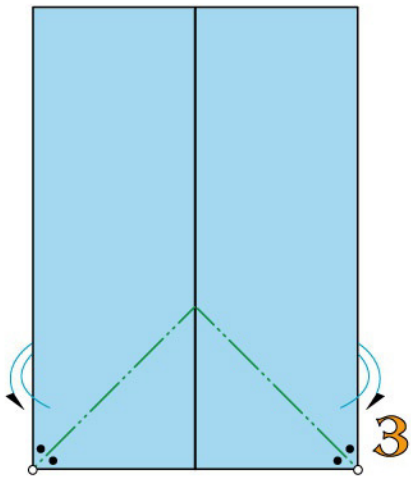

2 pieghe bisettrici a monte

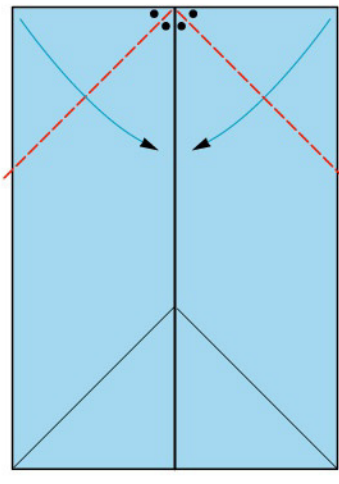

2 pieghe bisettrici a valle

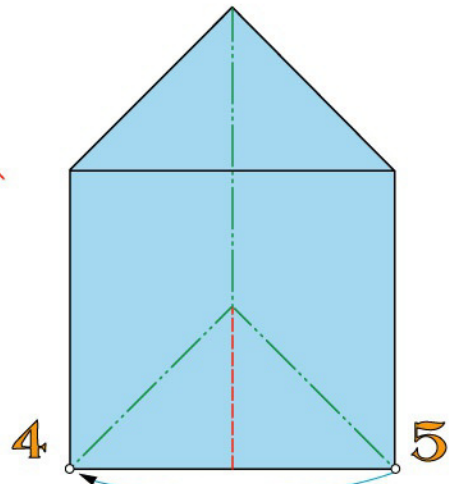

Ripiegate a valle e a monte

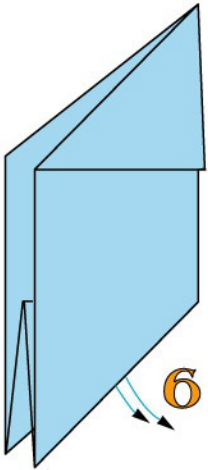

Estraete le superfici interne

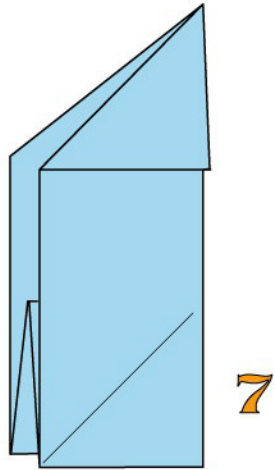

Modulo ultimato

UNIONE DEI MODULI

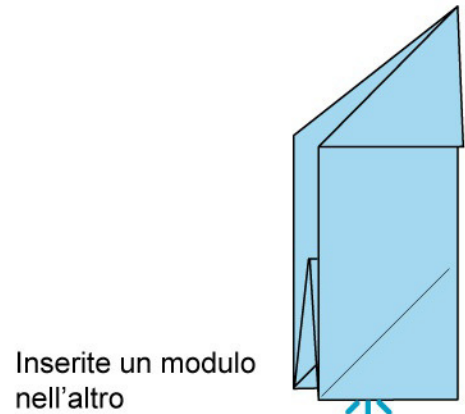

Inserite un modulo nell'altro

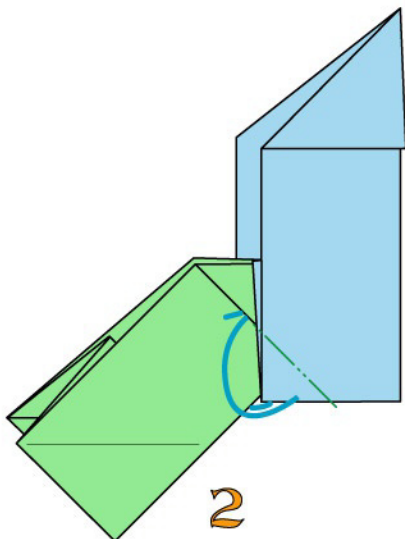

2 pieghe a monte, 1 per lato e intascate

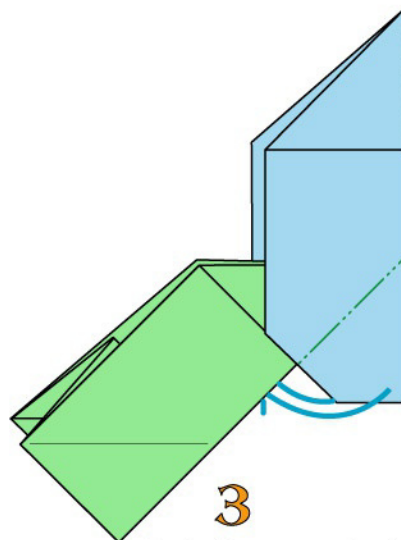

2 pieghe a monte, 1 per lato e intascate

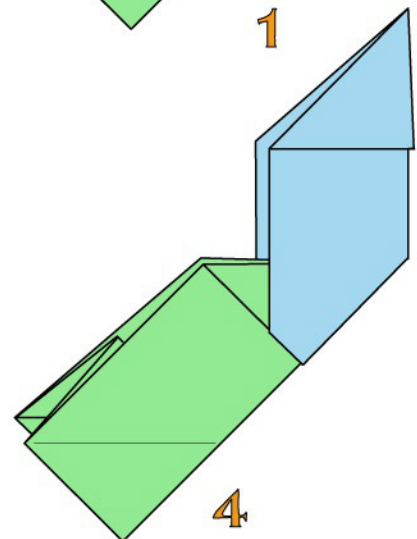

Unione completata

GHIRLANDA "D"

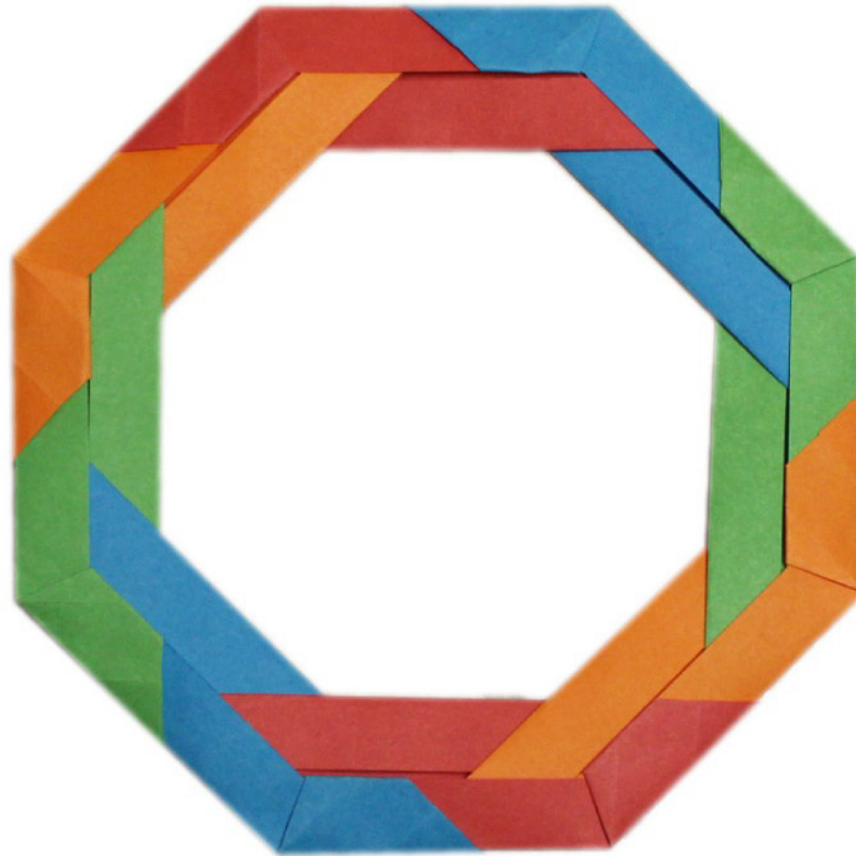

Adoperate 8 mezzi quadrati di carta monocolore

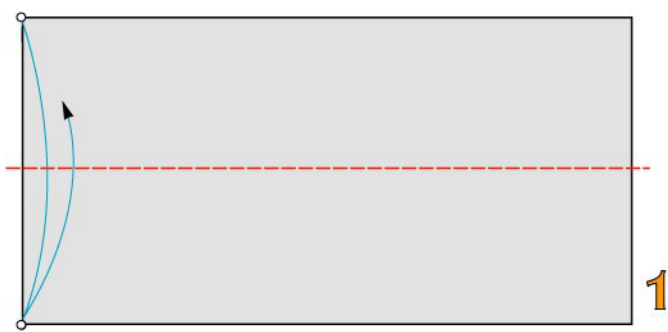

1 piega a valle

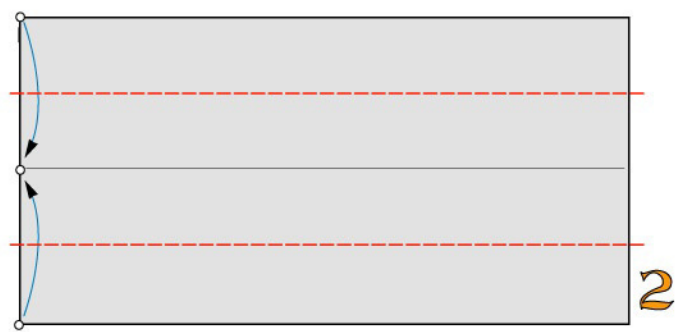

2 pieghe a valle

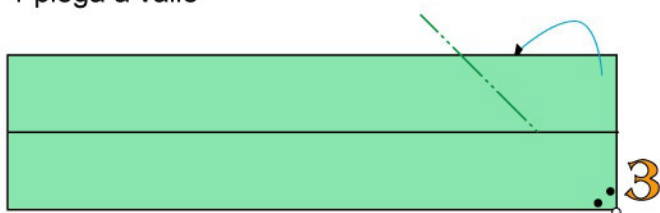

1 piega a monte

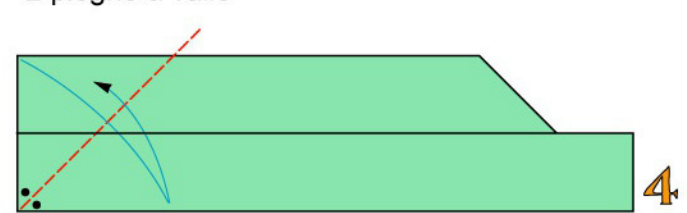

1 piega bisettrice a valle

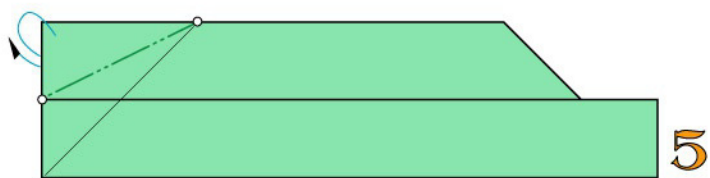

1 piega a monte

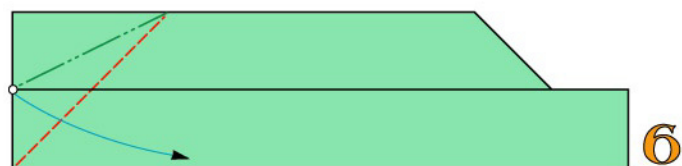

1 piega a valle e ripiegate a monte

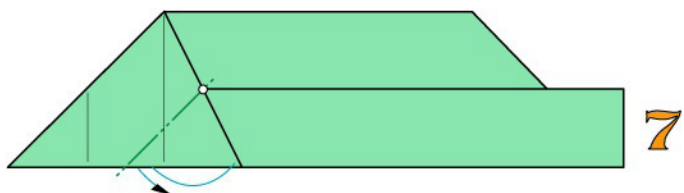

1 piega a monte

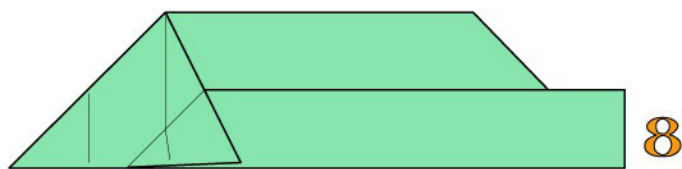

Modulo ultimato

UNIONE DEI MODULI

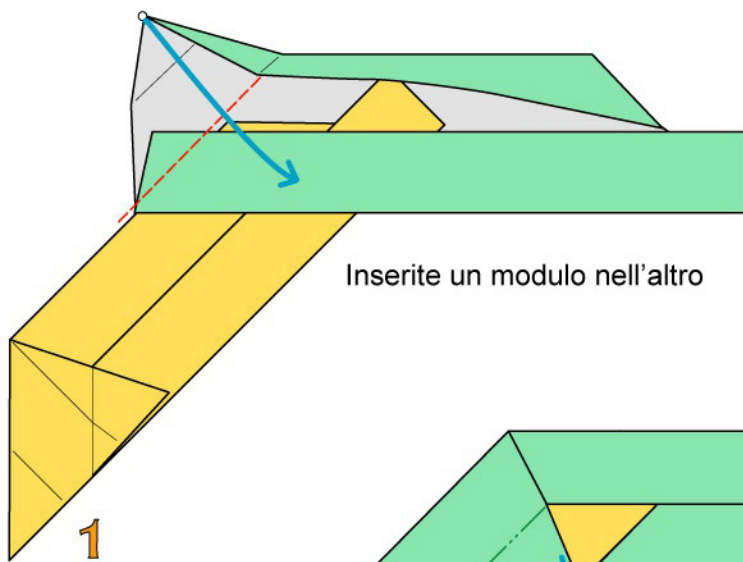

Inserite un modulo nell'altro

1

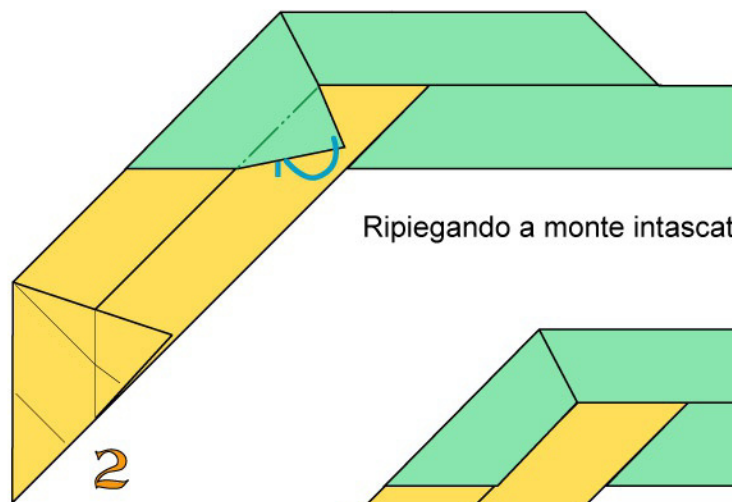

Ripiegando a monte intascate bloccando l'unione

2

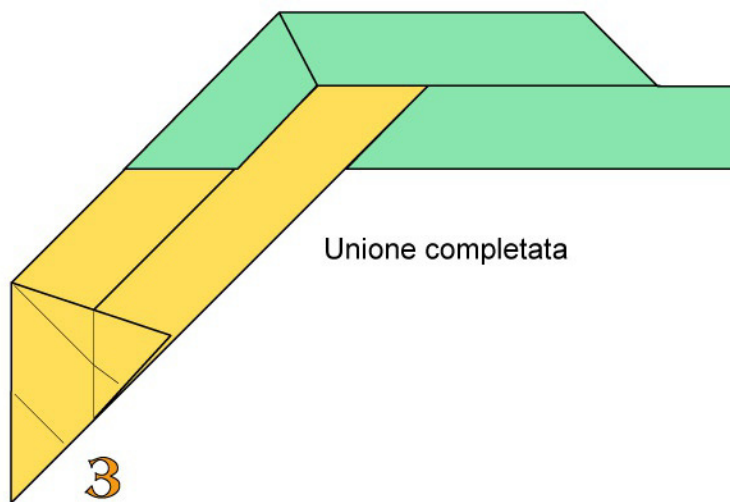

Unione completata

3

GHIRLANDA "€"

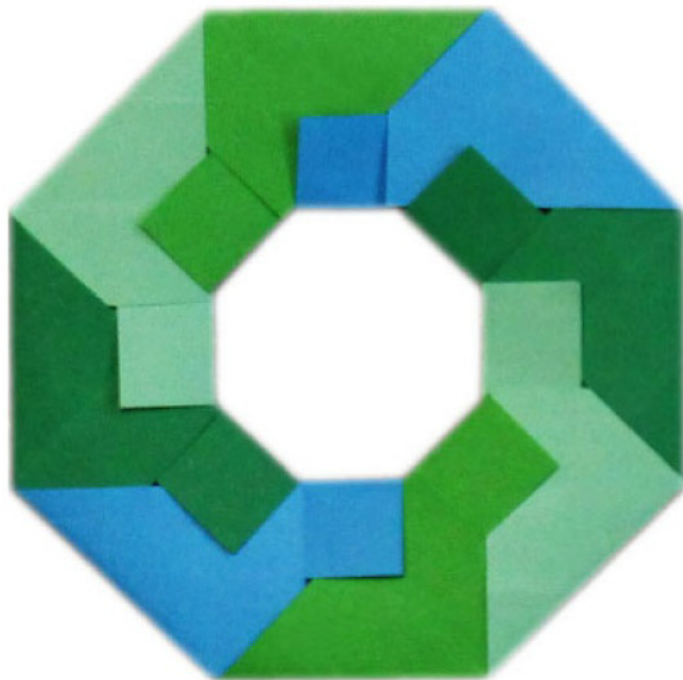

Adoperate 8 fogli quadrati di carta monocolore o bicolore

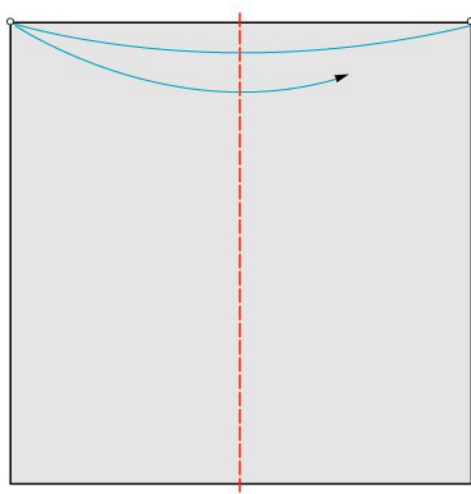

1 piega a valle

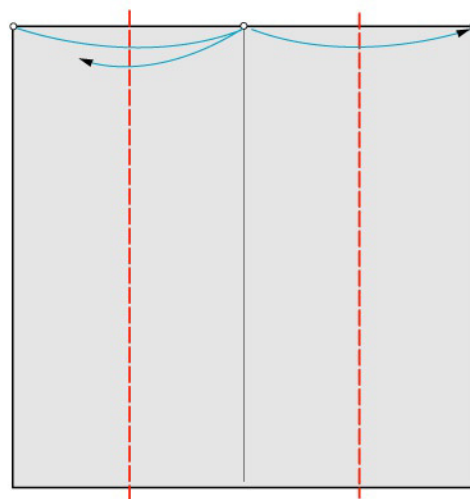

2 pieghe a valle

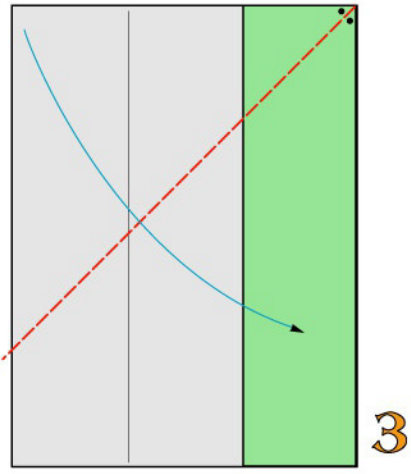

1 piega bisettrice a valle

3

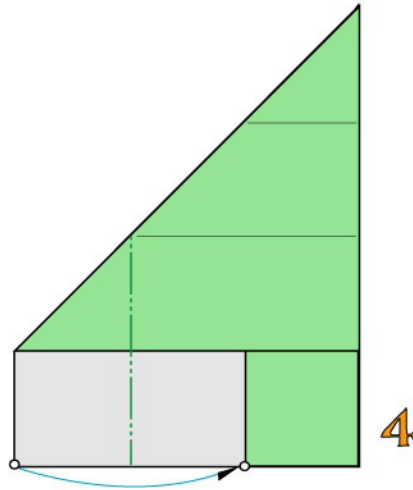

1 piega a monte

4

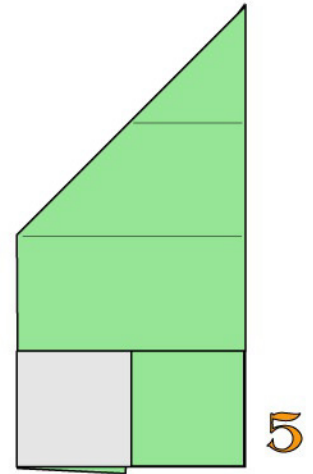

Modulo ultimato



UNIONE DEI MODULI

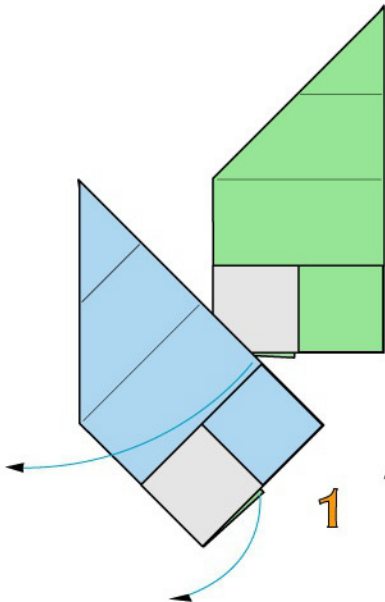

Aprire un modulo

1

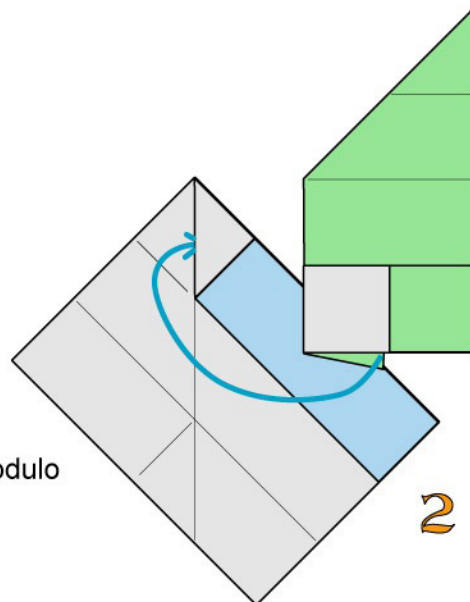

Intascate un modulo nell'altro

2

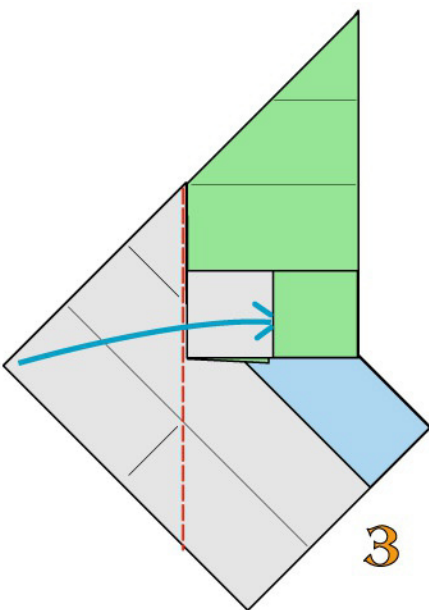

Ripiegando a valle intascate

3

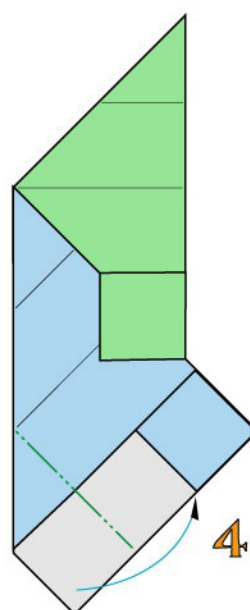

Ripiegate a monte

4

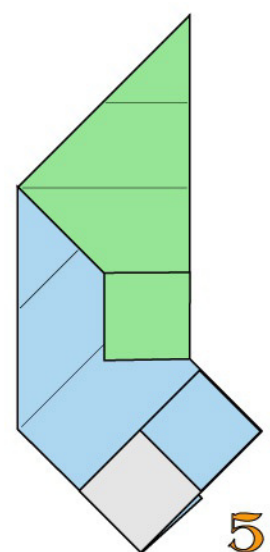

Unione completata

5

GHIRLANDA "F"



Adoperate 8 mezzi quadrati di carta monocolora o bicolore

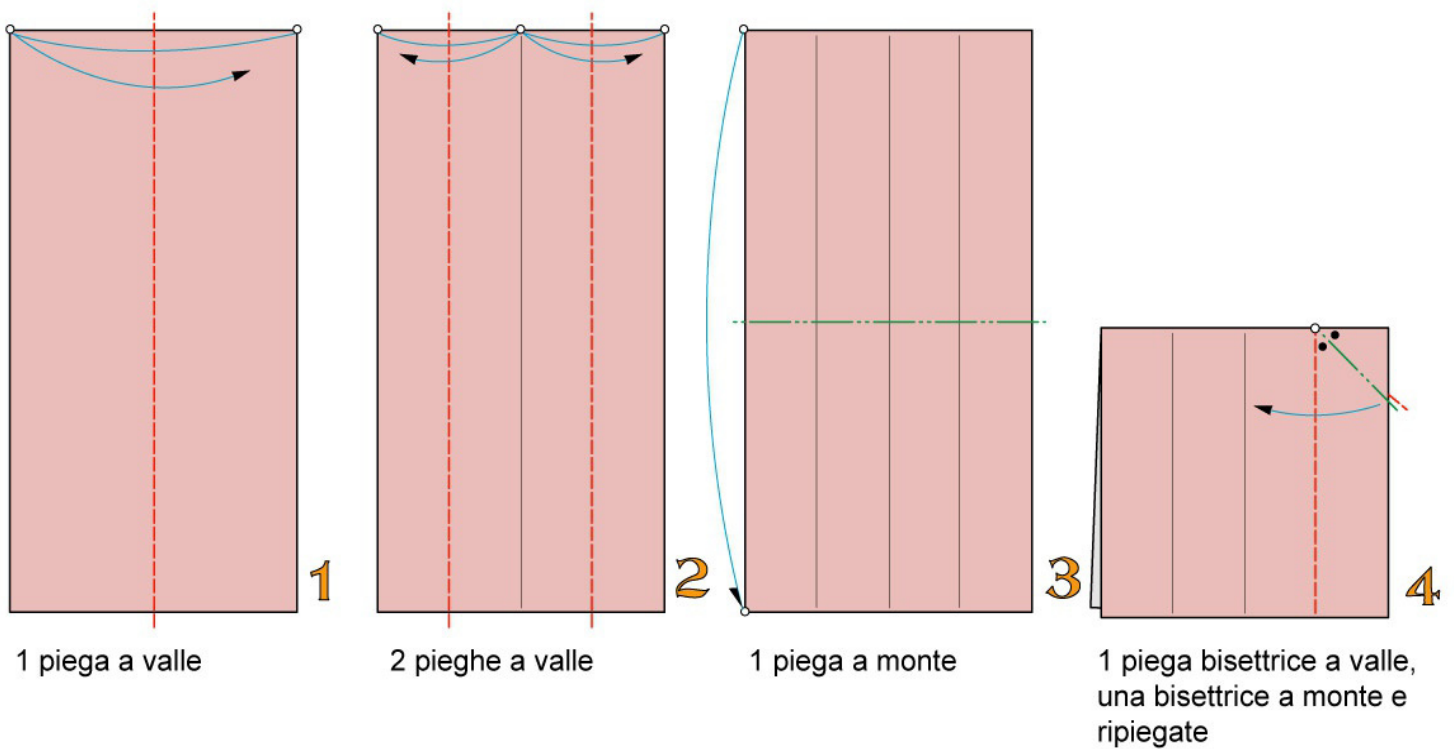

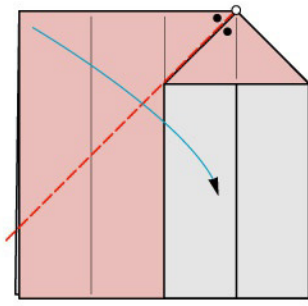

1 piega bisettrice a valle

5

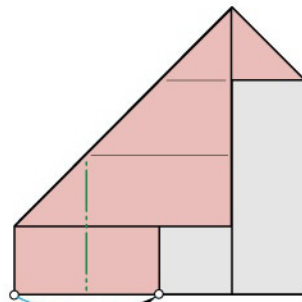

1 piega a monte

6

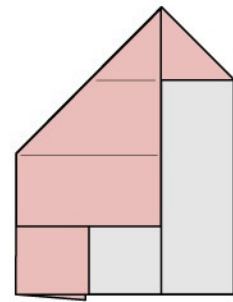

Modulo ultimato

7

UNIONE DEI MODULI

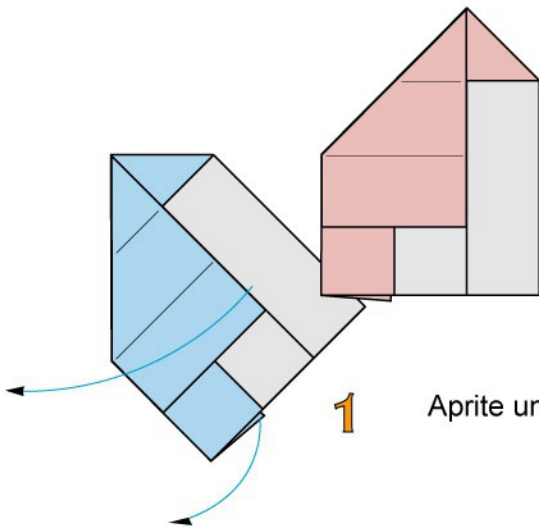

1

Aprite un modulo

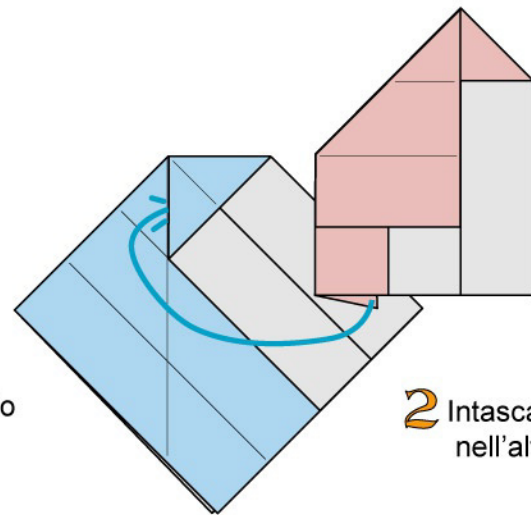

2

Intascate un modulo nell'altro

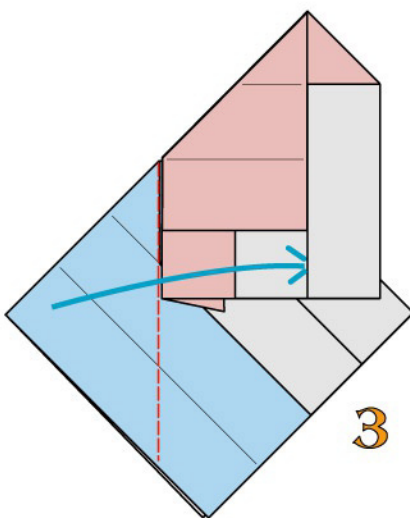

3

Ripiegando a valle intascate

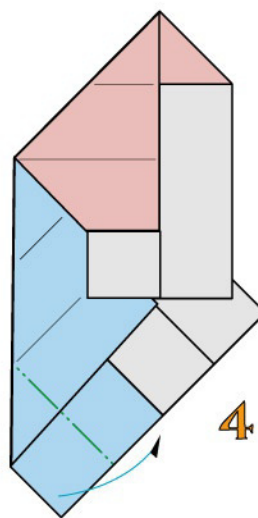

4

Ripiegate a monte

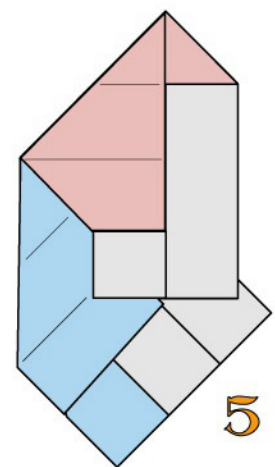

5

Unione completata

GHIRLANDA "G"

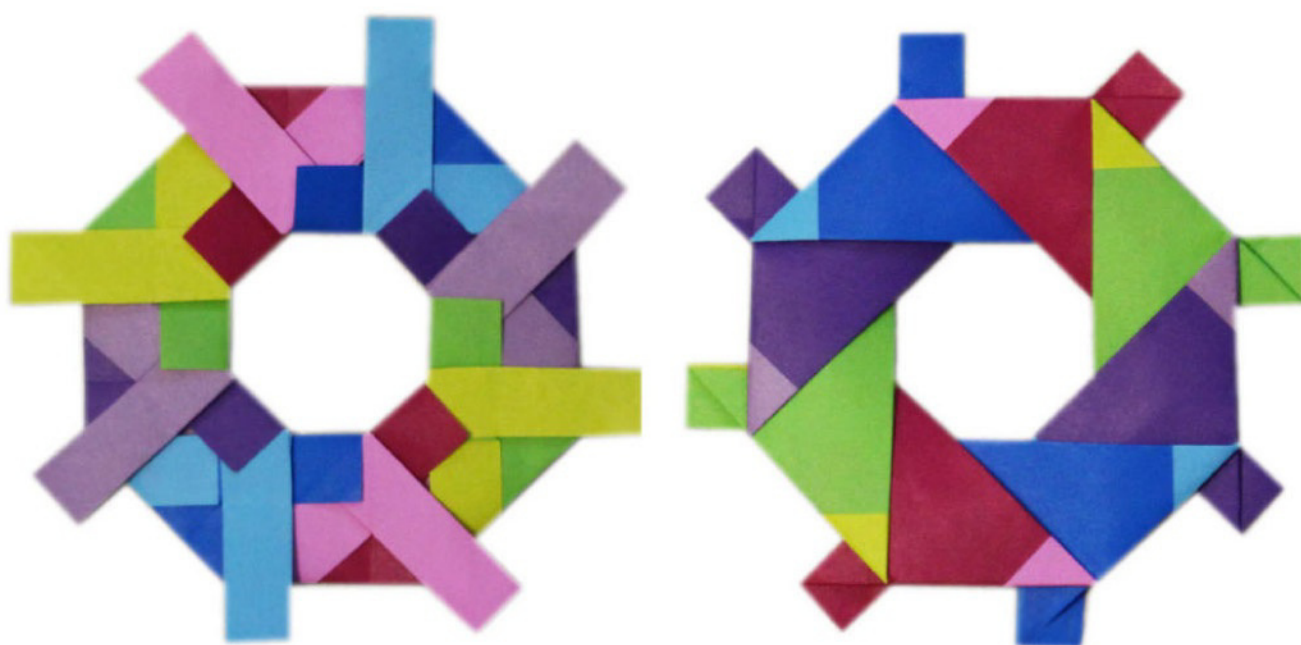

Adoperate 8 mezzi quadrati di carta bicolore

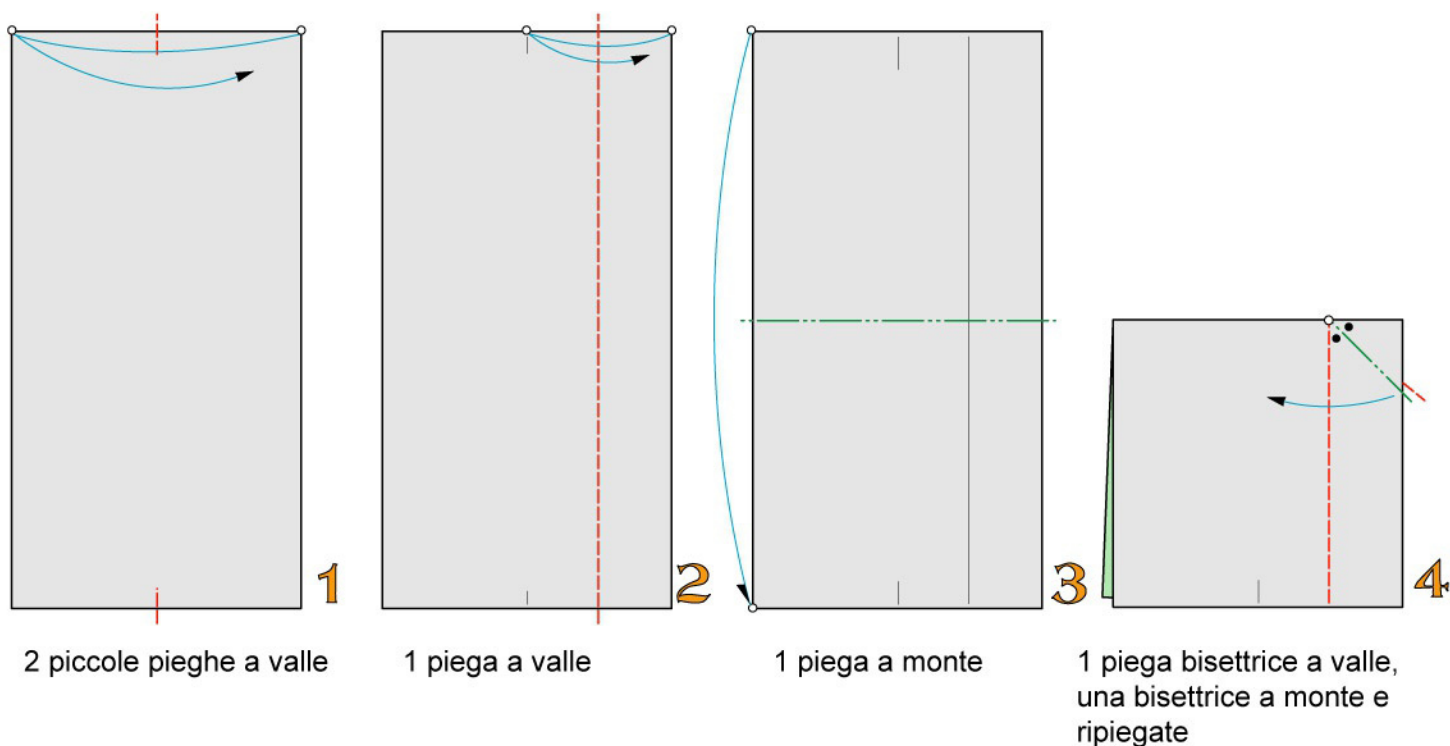

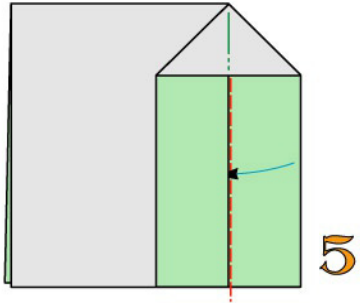

Ripiegando a valle intascate

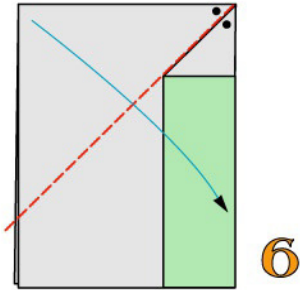

1 piega bisettrice a valle

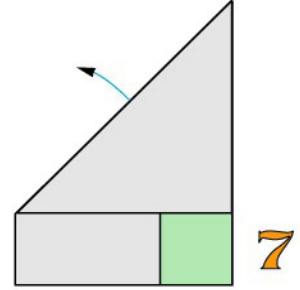

Estraete la superficie sottostante

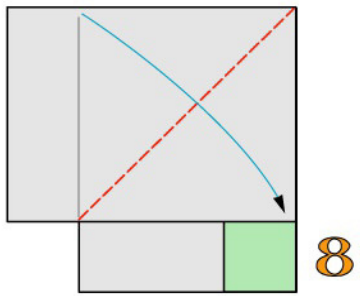

Ripiegate a valle

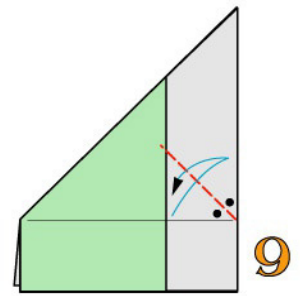

1 piega bisettrice a valle

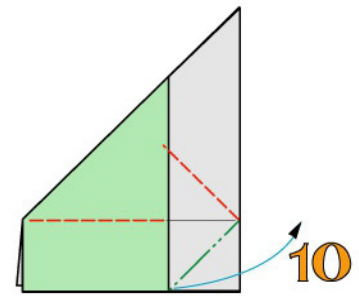

1 piega bisettrice a monte e ripiegate

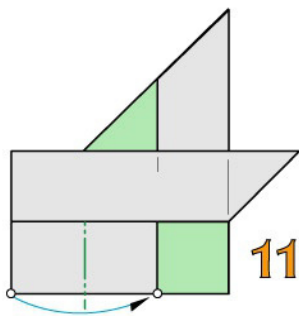

1 piega a monte

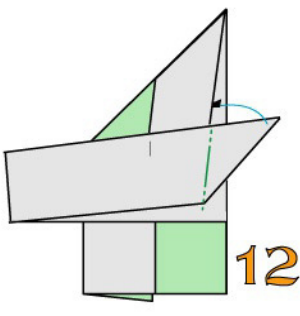

Ripiegando a monte intascate

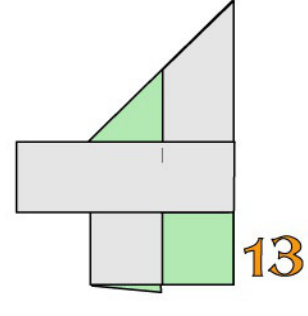

Modulo ultimato

UNIONE DEI MODULI

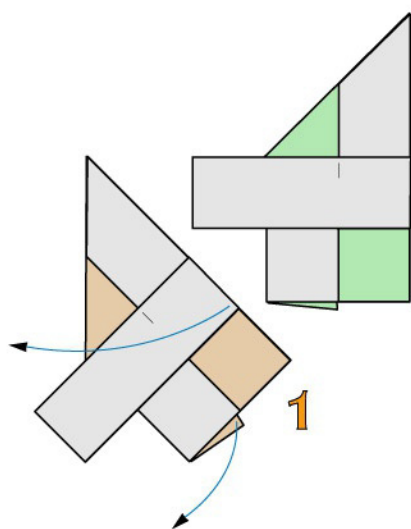

Aprite un modulo

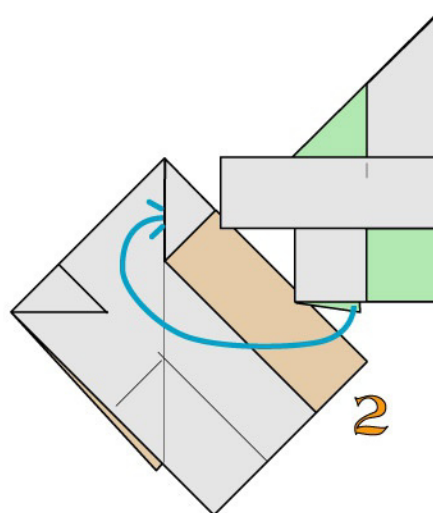

Intascate un modulo nell'altro

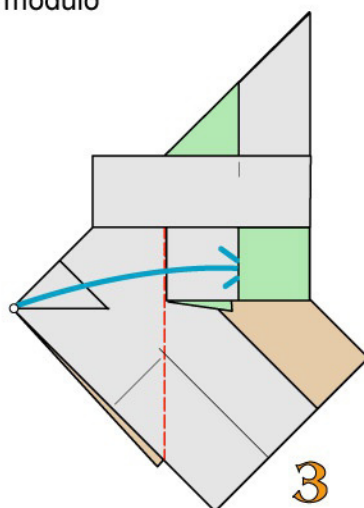

Ripiegando a valle intascate

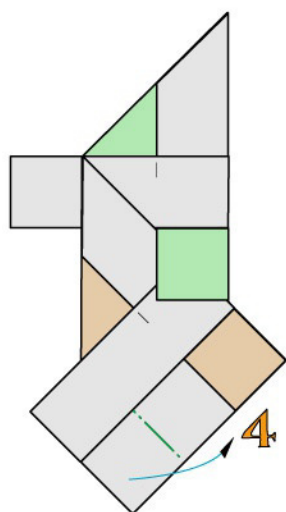

Ripiegate a monte

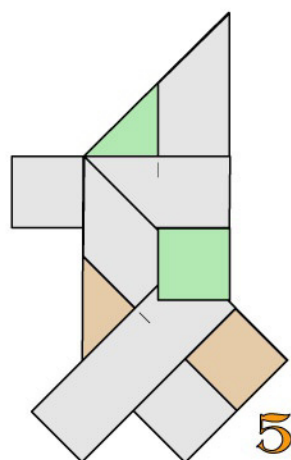

Unione completata

GHIRLANDA "H"

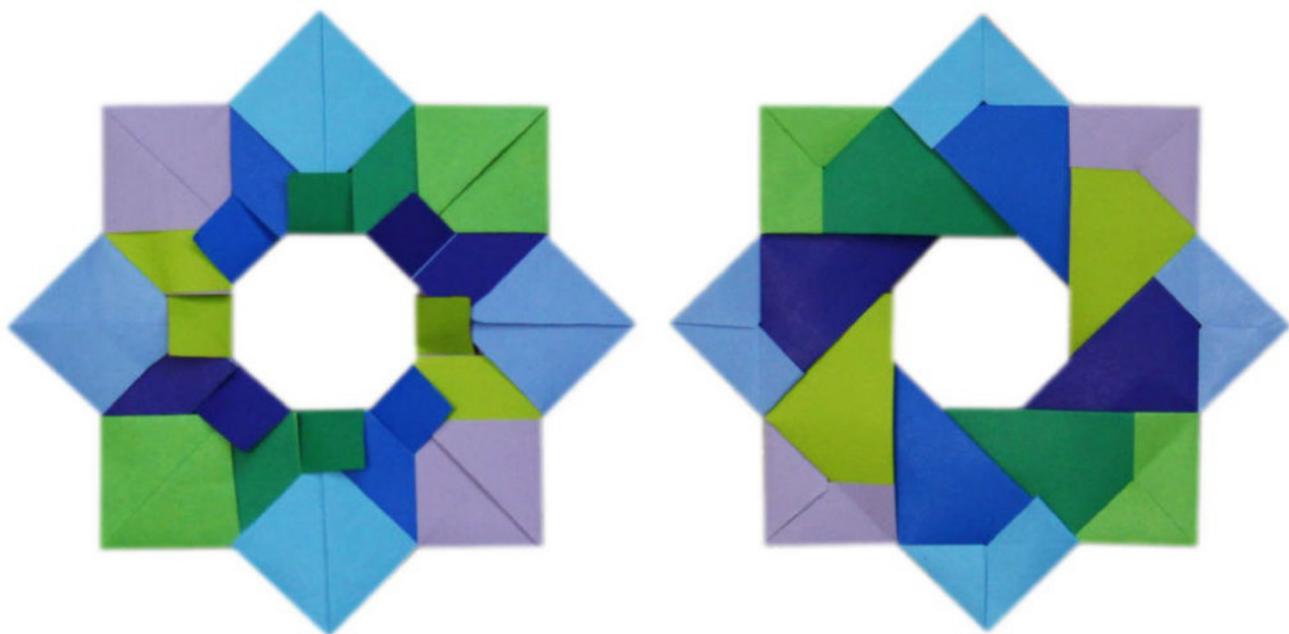

Adoperate 8 mezzi quadrati di carta bicolore

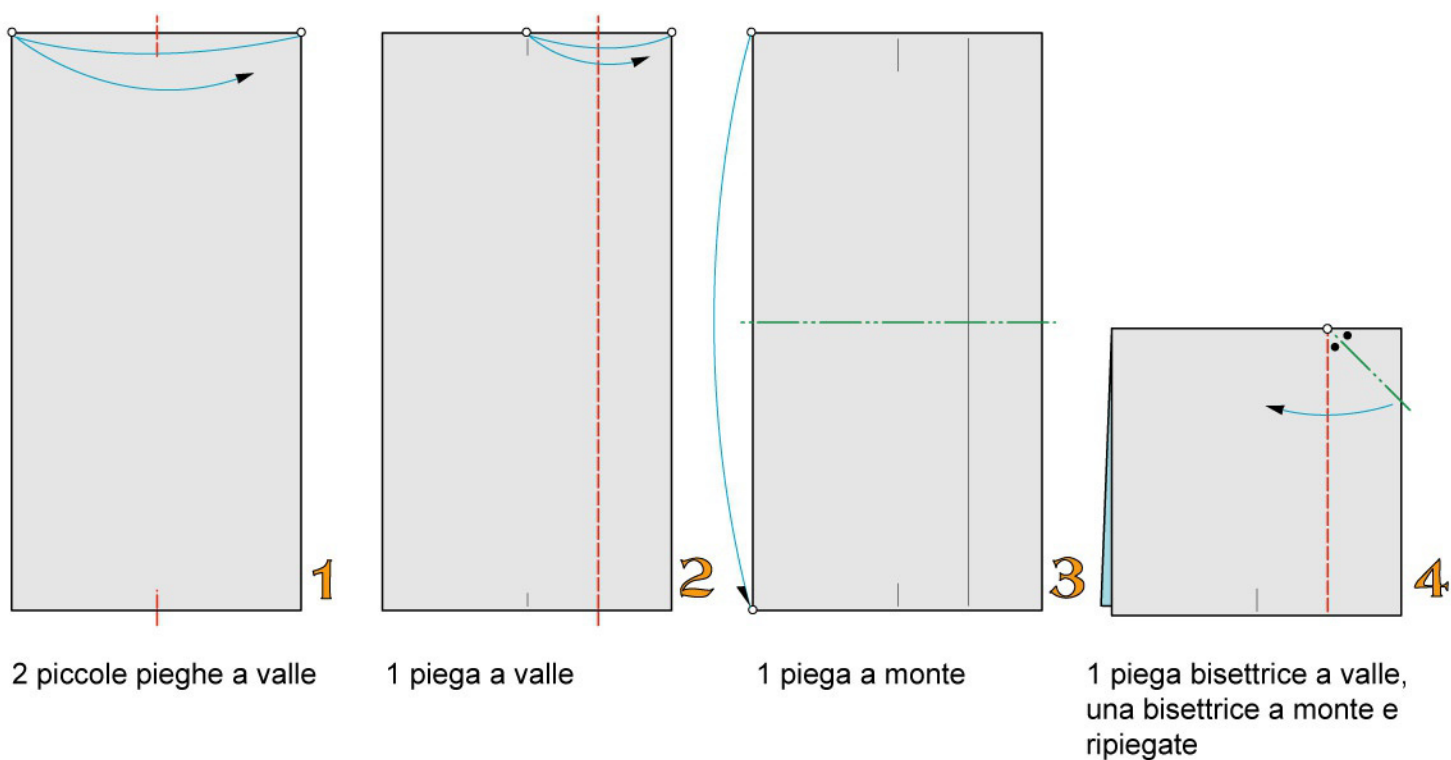

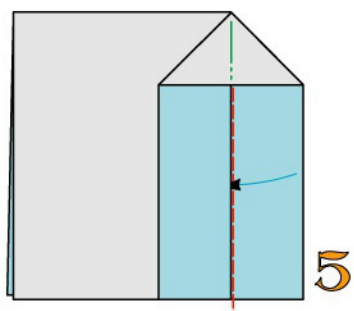

Ripiegando a valle intascate

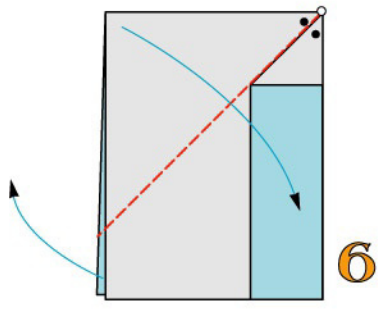

1 piega bisettrice a valle

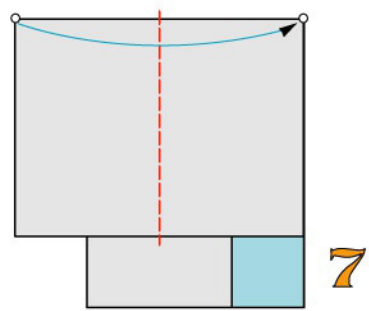

1 piega a valle

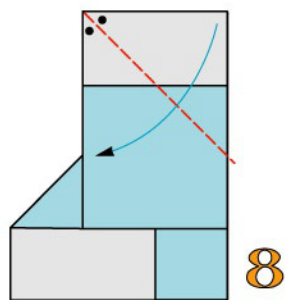

1 piega bisettrice a valle

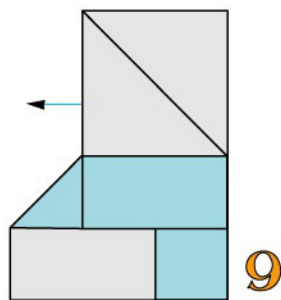

Estraete la superficie sottostante

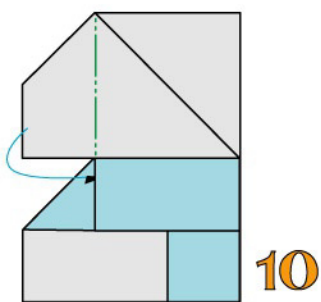

Ripiegando a monte intascate

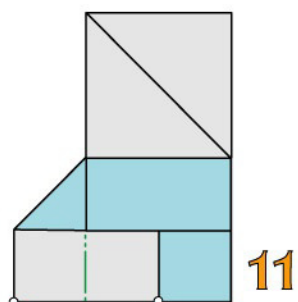

Ripiegate a monte

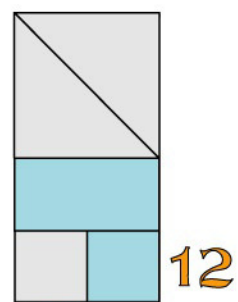

Modulo ultimato

UNIONE DEI MODULI

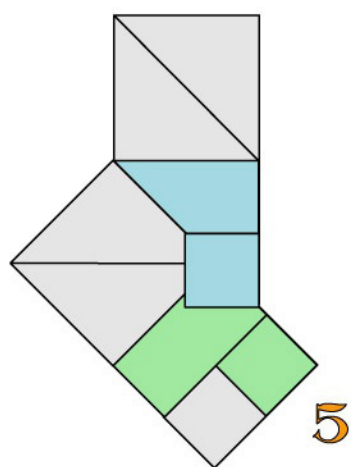
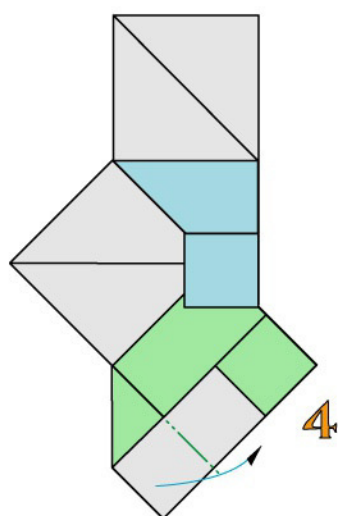
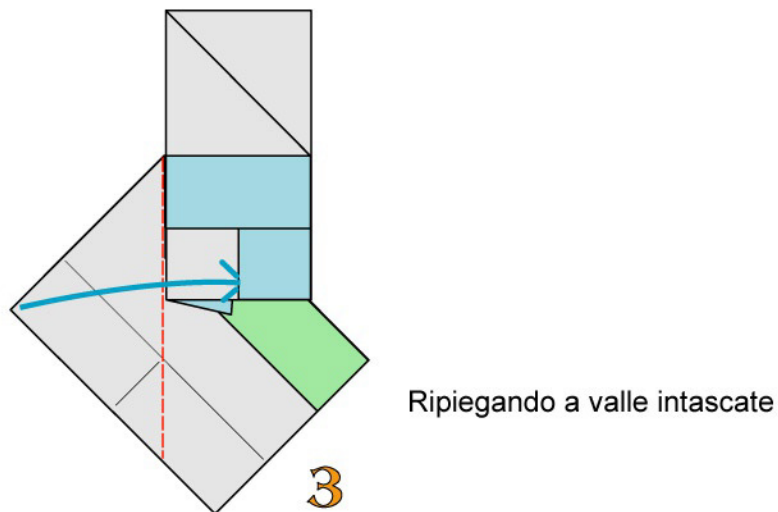
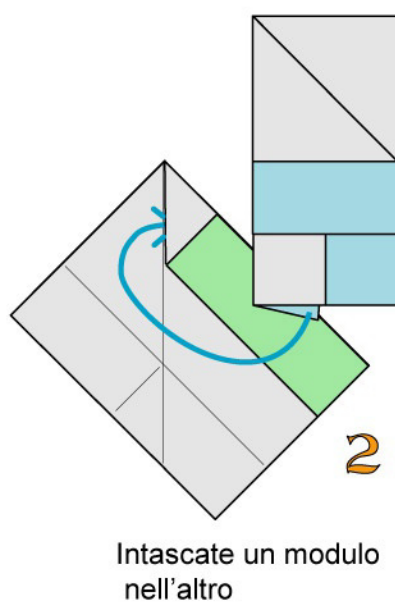
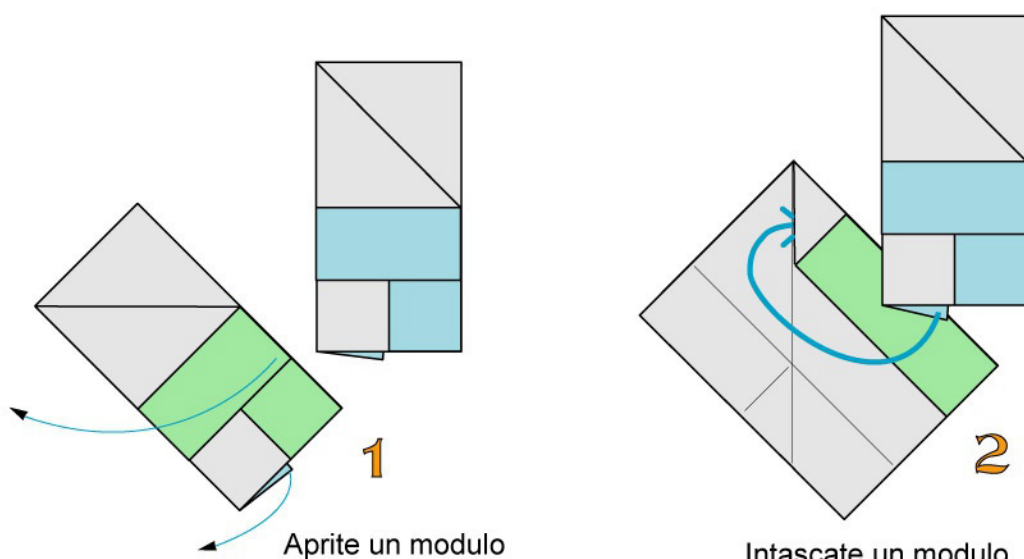

GHIRLANDA "I"

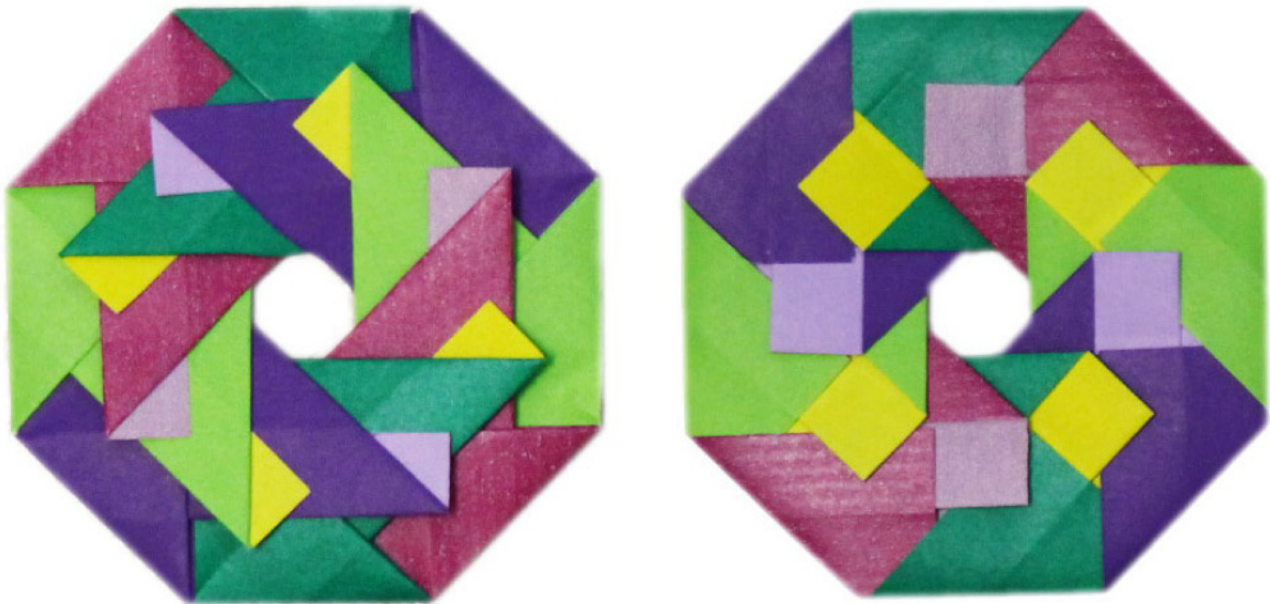

Adoperate 8 mezzi quadrati di carta bicolore

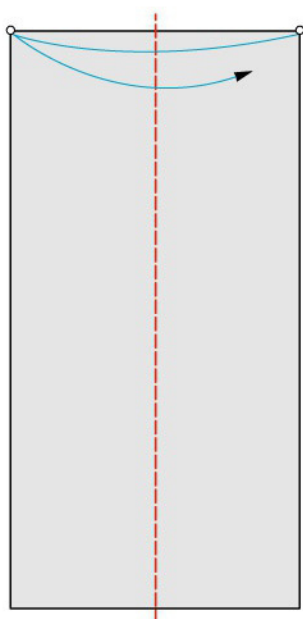

1

1 piega a valle



2

2 pieghe a valle

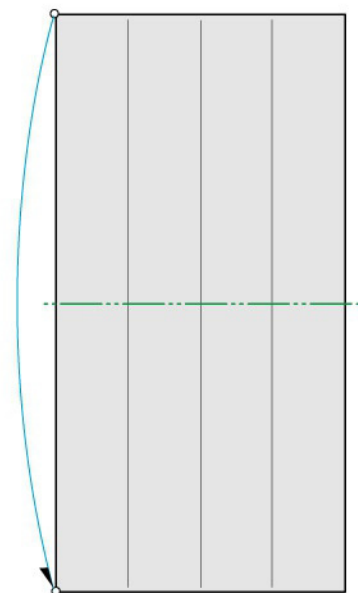

3

1 piega a monte

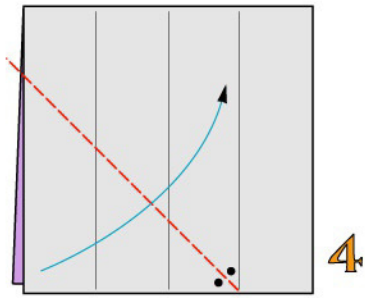

1 piega bisettrice a valle solo sulla superficie in vista

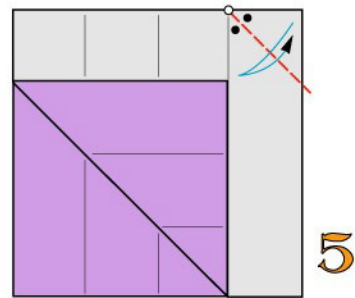

1 piega bisettrice a valle

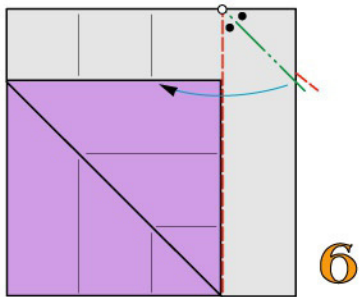

Ripiegate a valle e a monte

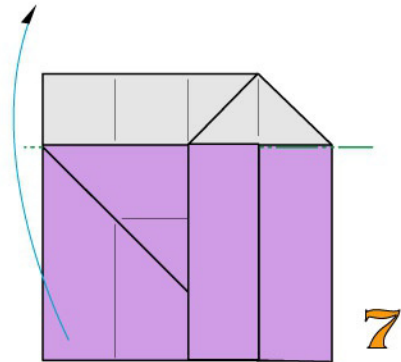

Ripiegate a monte

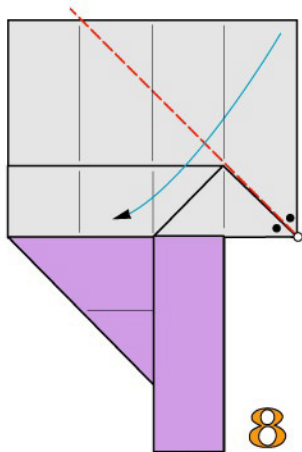

1 piega bisettrice a valle

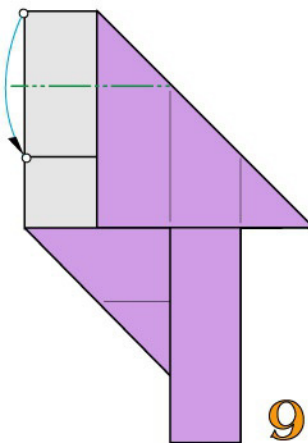

1 piega a monte

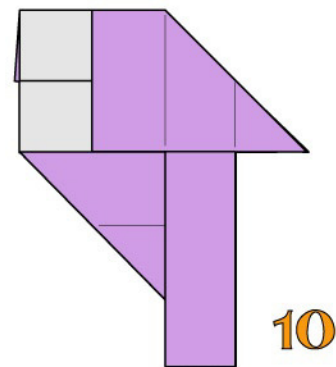

Modulo ultimato

UNIONE DEI MODULI

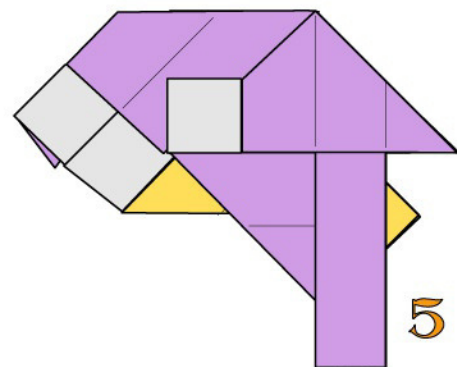
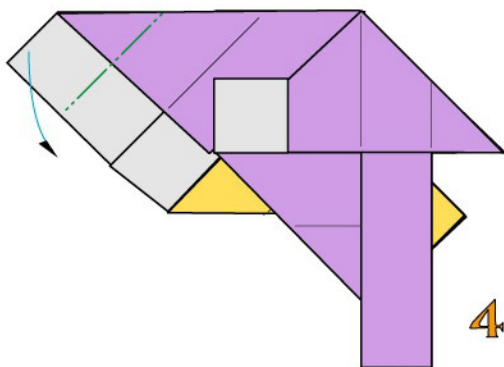
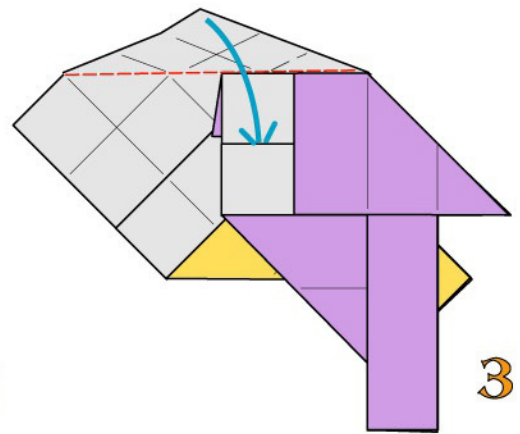
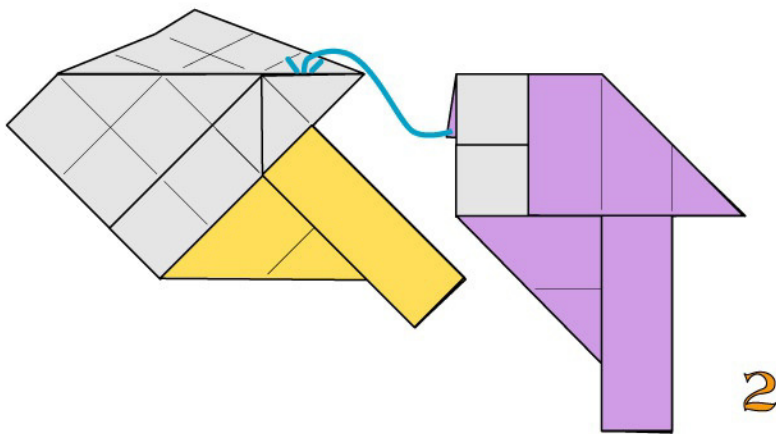
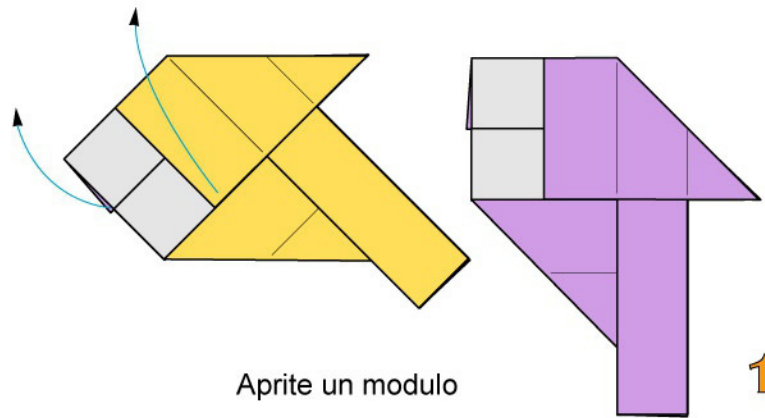

GHIRLANDA "L"

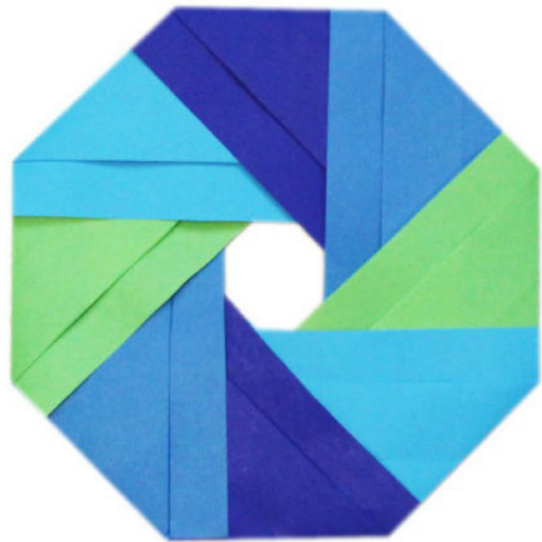

Adoperate 8 fogli A4 o frazioni di A4, monocolori o bicolori

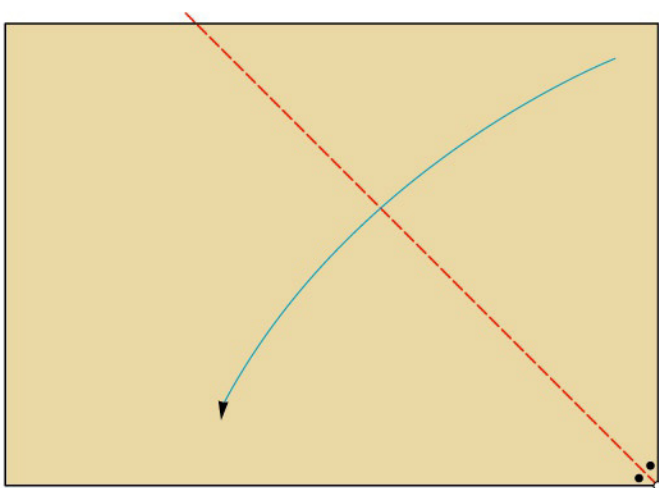

1 piega bisettrice a valle

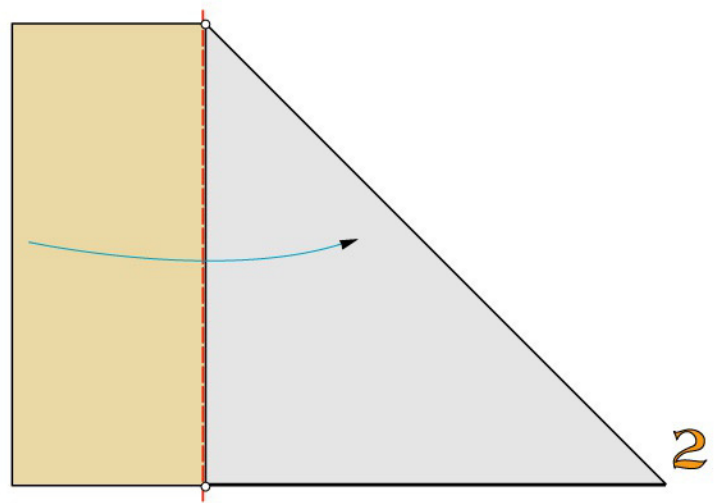

1 piega a valle

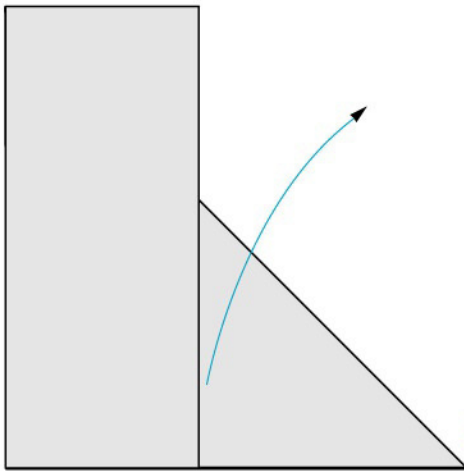

3

Aprite

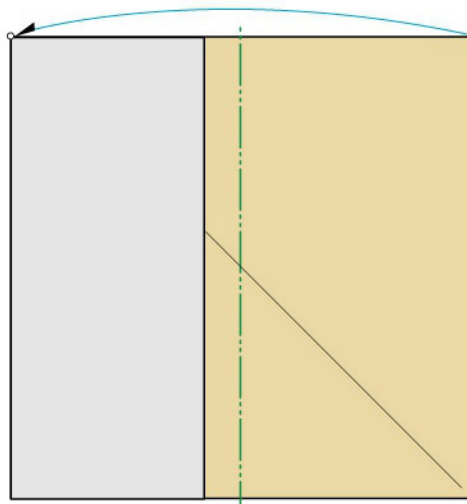

4

1 piega a monte

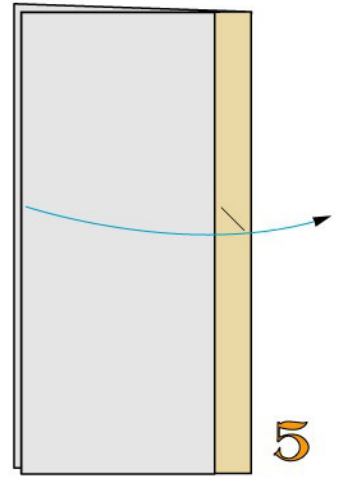

5

Aprite

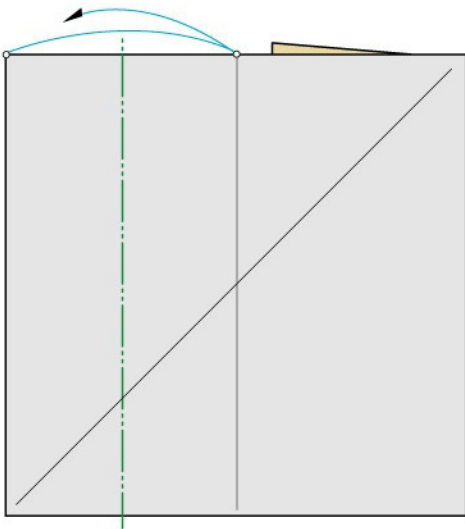

6

1 piega a monte

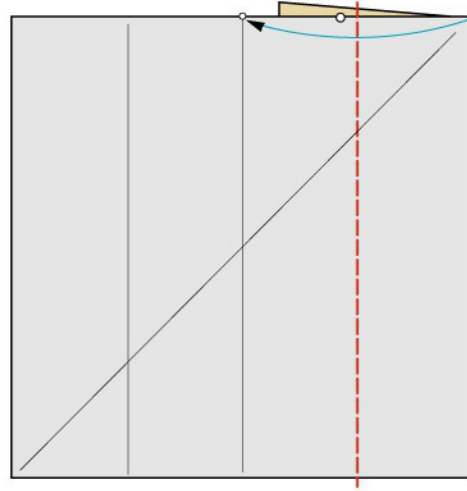

7

1 piega a valle

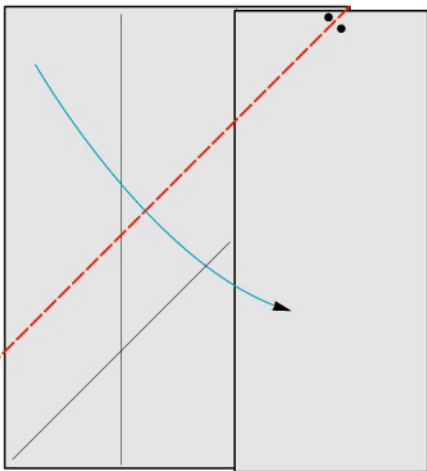

8

1 piega bisettrice a valle

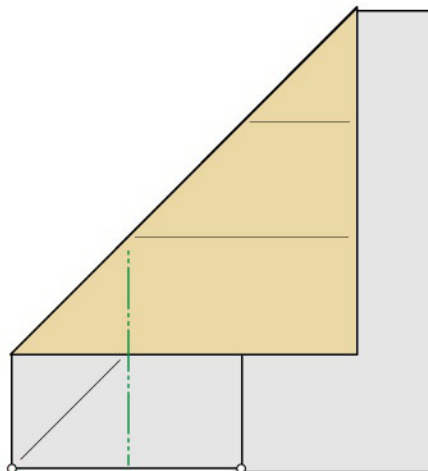

9

1 piega a monte

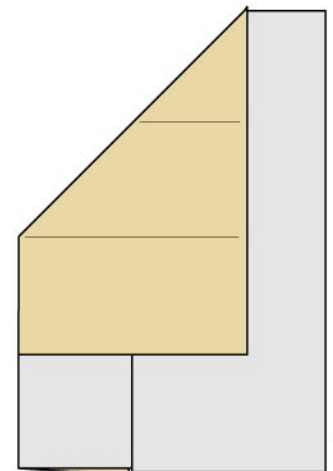

10

Modulo ultimato



UNIONE DEI MODULI

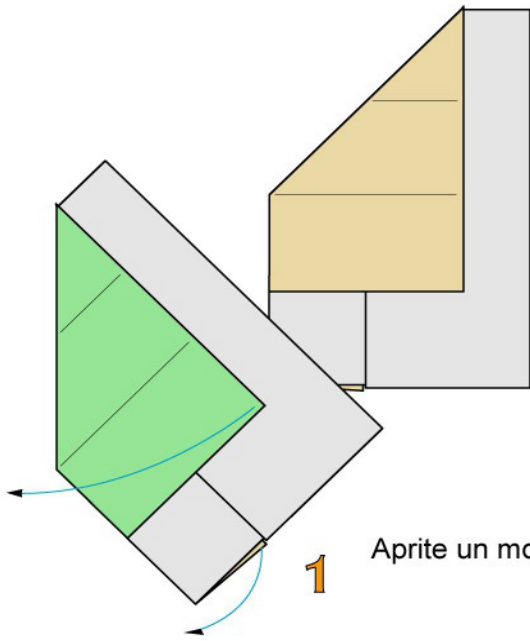

Aprire un modulo

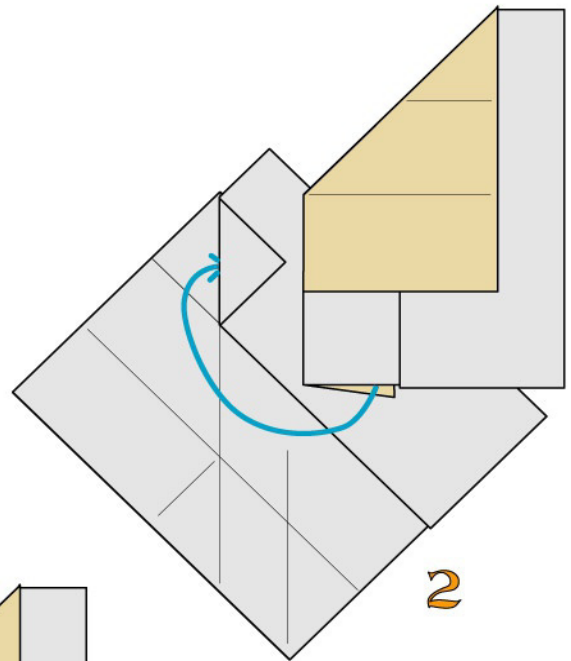

Intascate un modulo nell'altro

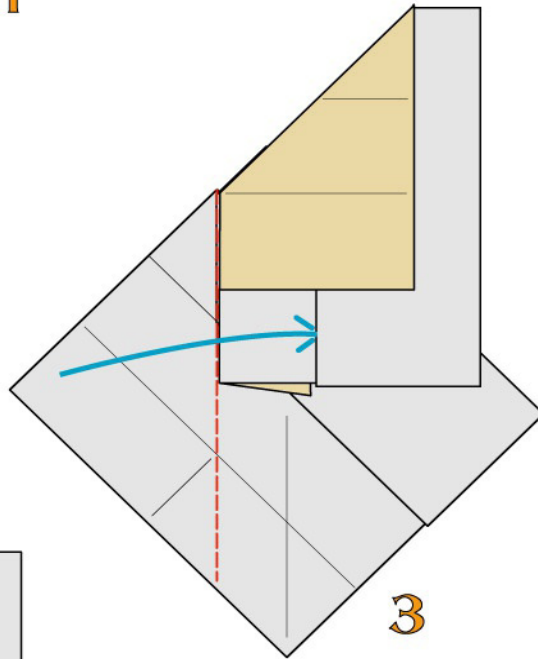

Ripiegando a valle intascate

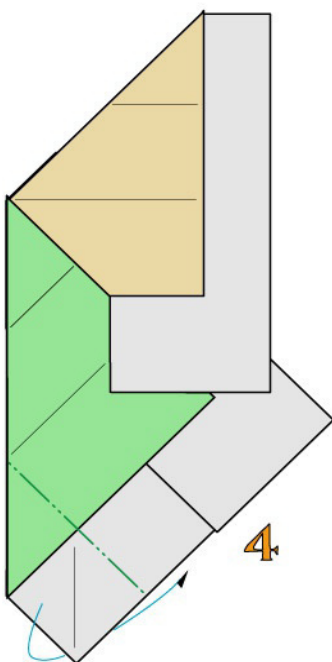

Ripiegate a monte

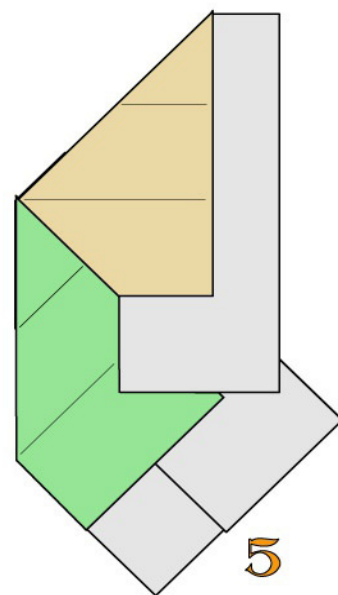

Unione completata

GHIRLANDA "M"

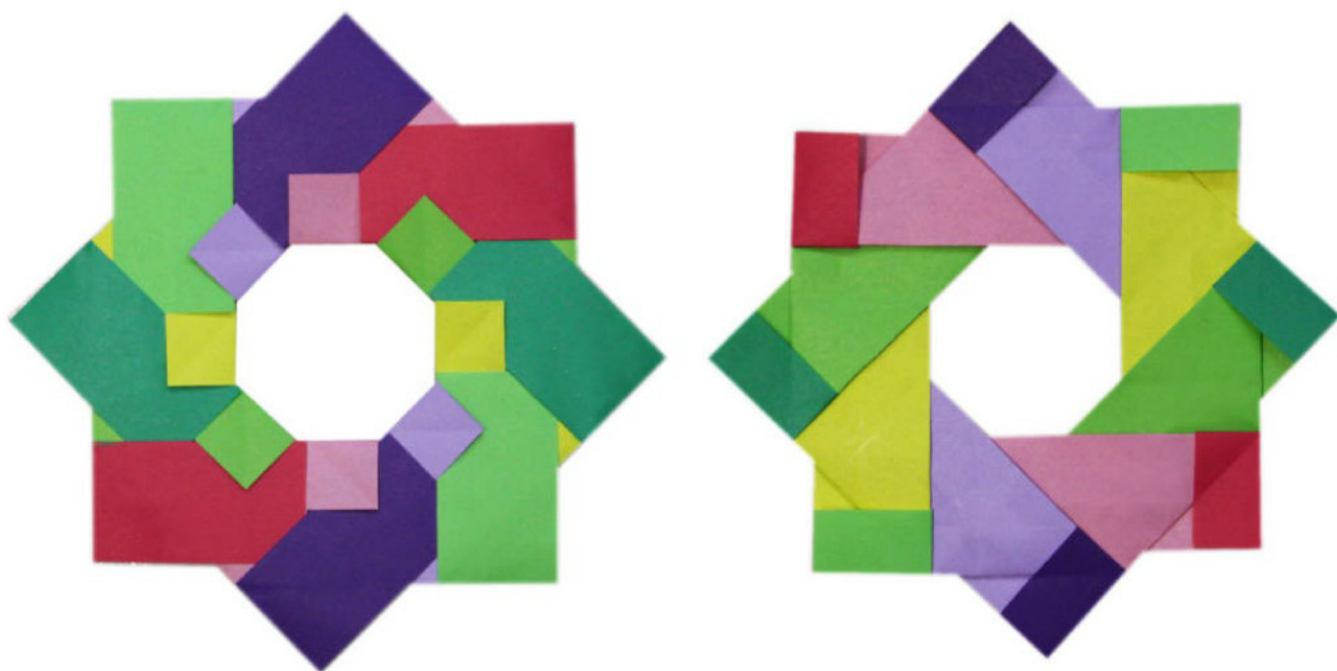

Adoperate 8 fogli A4 o frazioni di A4, monocolori o bicolori

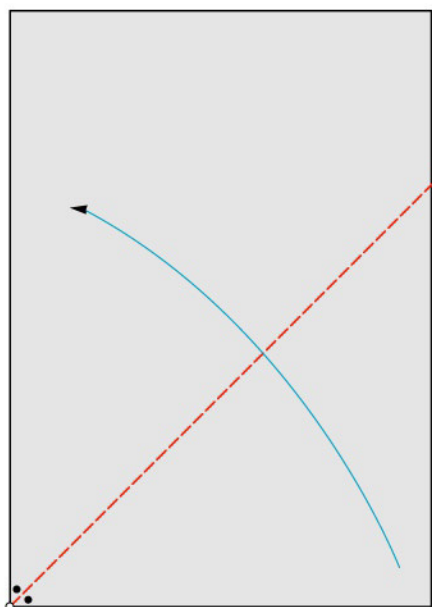

1 piega bisettrice a valle

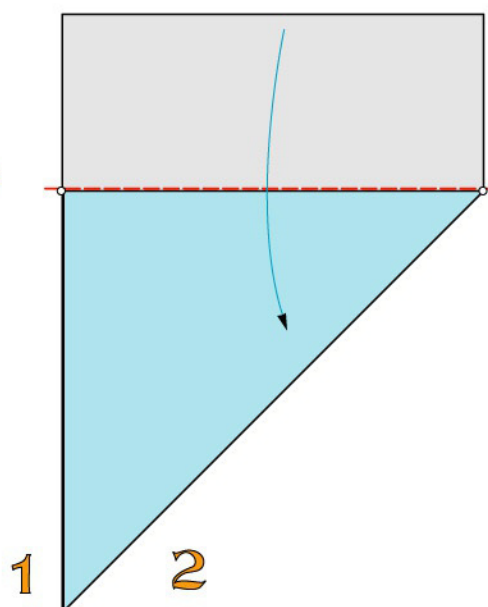

1 2

1 piega a valle

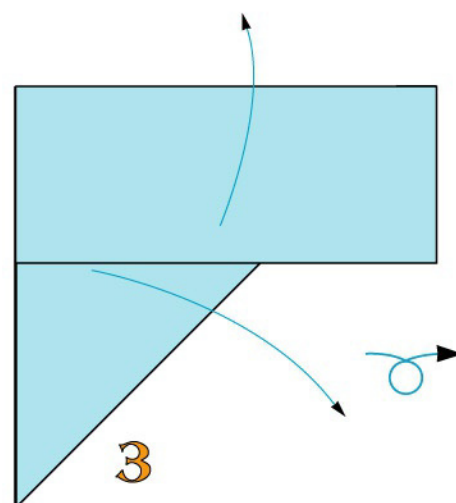

3

Aprite e ribaltate

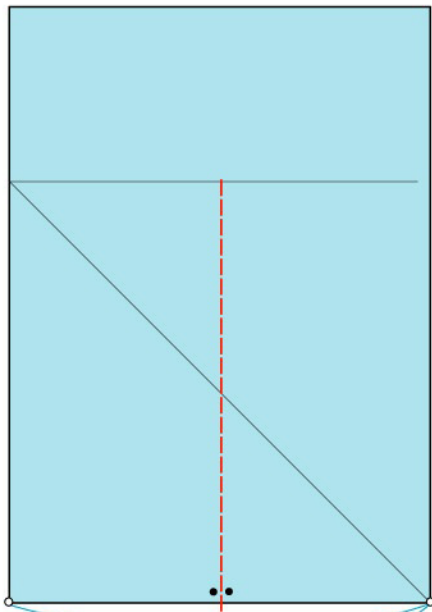

1 piega bisettrice a valle

4

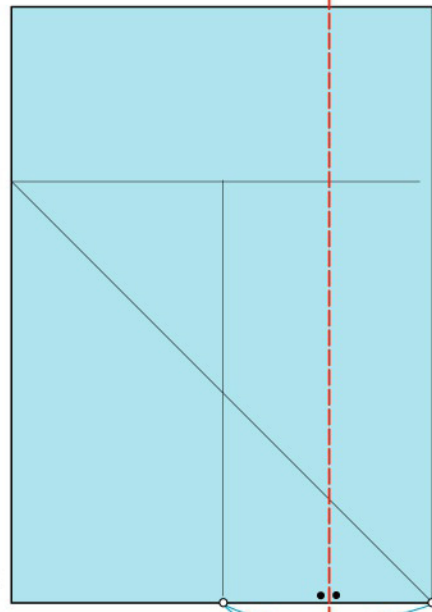

1 piega bisettrice a valle

5

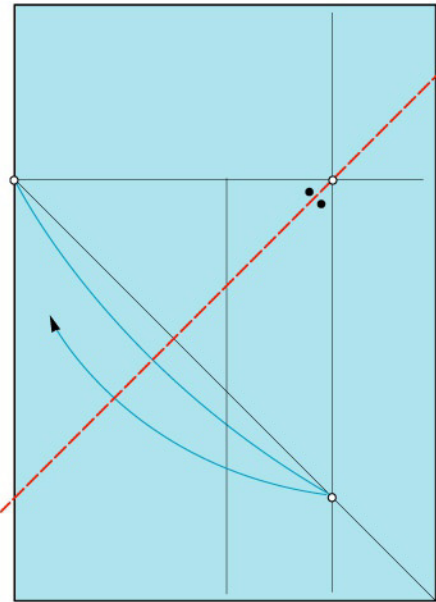

1 piega bisettrice a valle

6

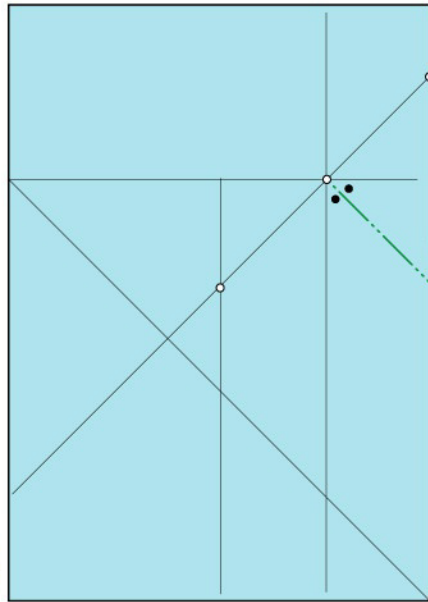

1 piega bisettrice a monte

7

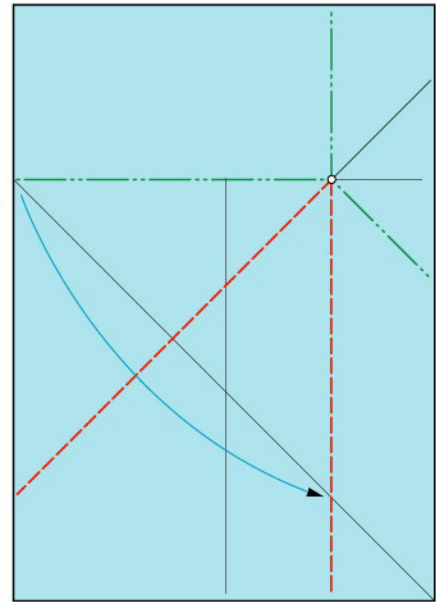

Ripiegate a valle e a monte

8

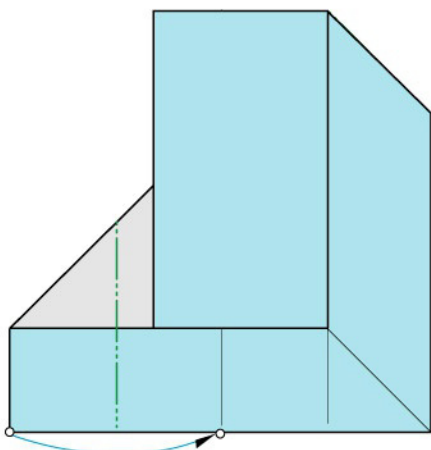

1 piega a monte

9

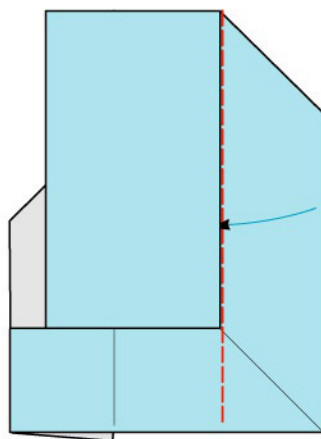

Ripiegando a valle intascate

10

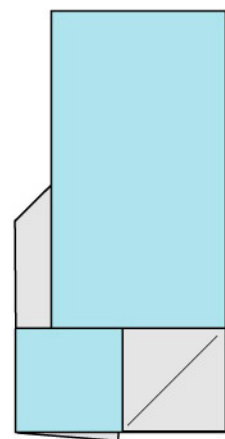

Modulo ultimato

11



UNIONE DEI MODULI

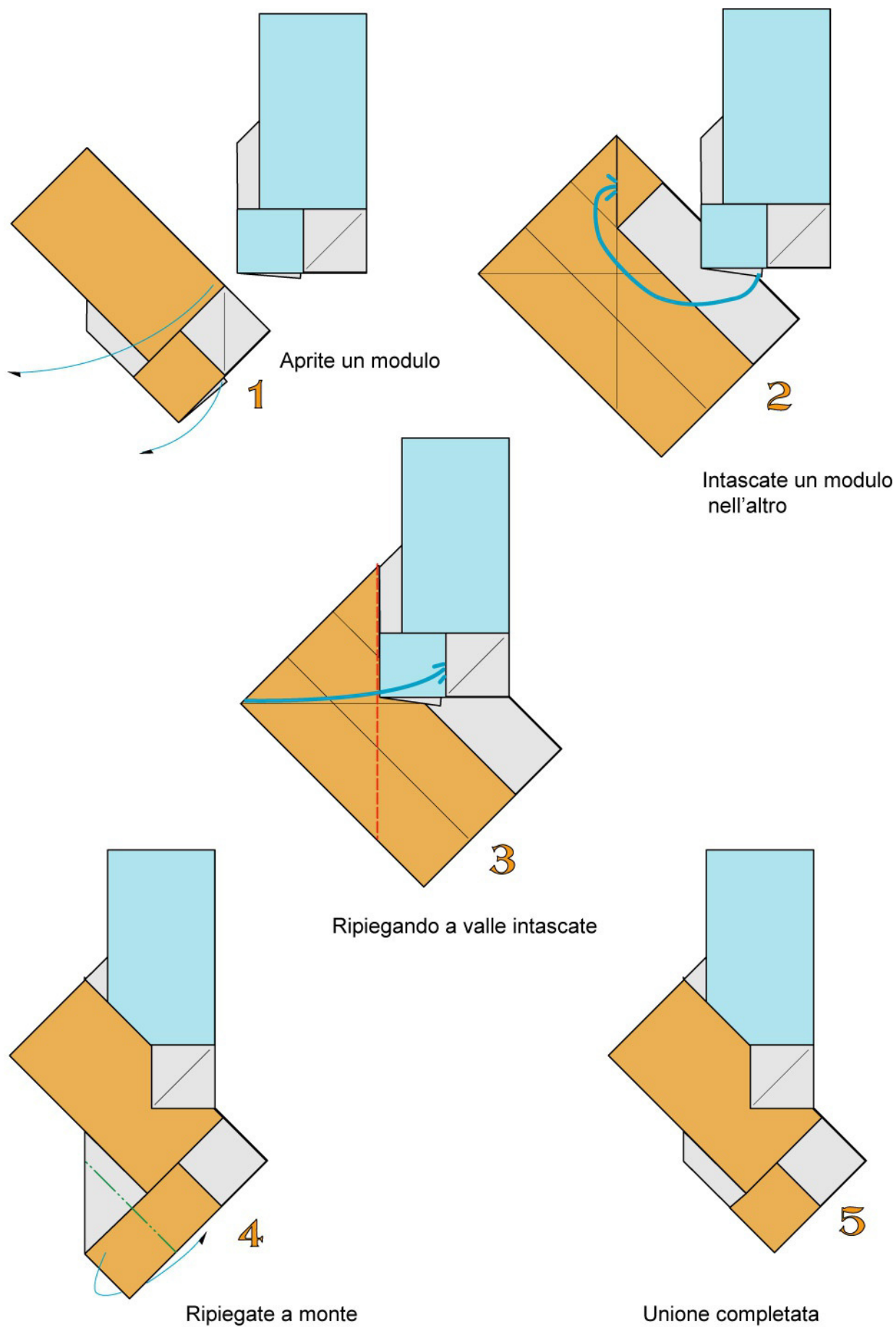

GHIRLANDA "N"

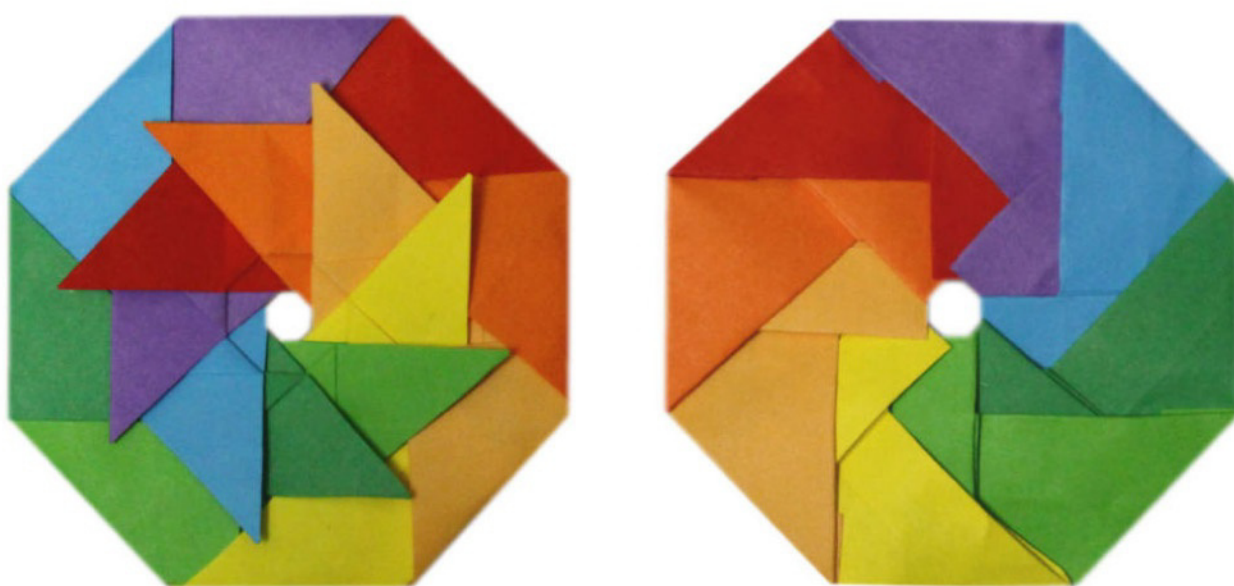

Adoperate 8 mezzi quadrati di carta monocolore

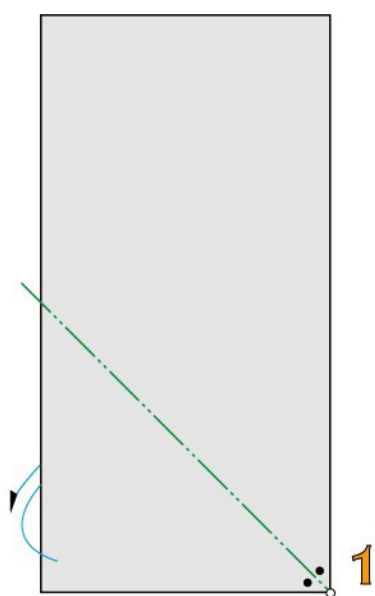

1 piega bisettrice a monte

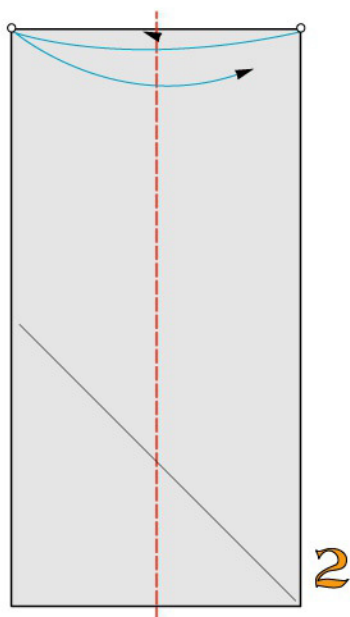

1 piega a valle

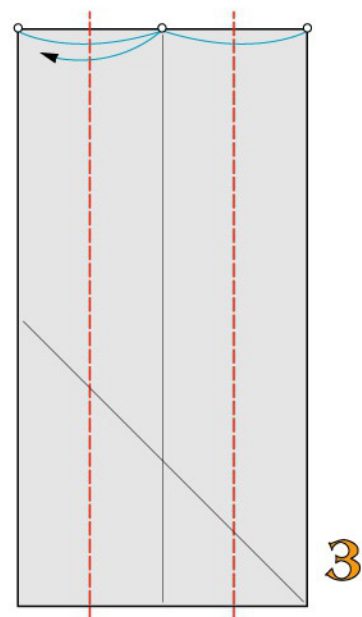

2 pieghe a valle

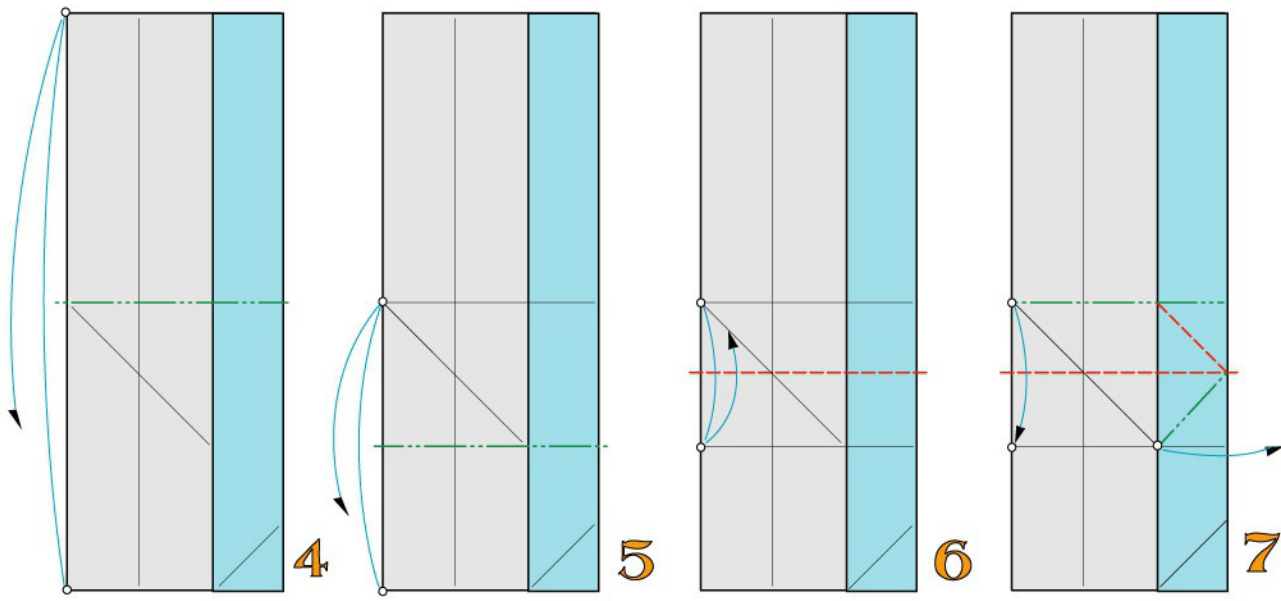

1 piega a monte

1 piega a monte

1 piega a valle

Ripiegate a valle e a monte

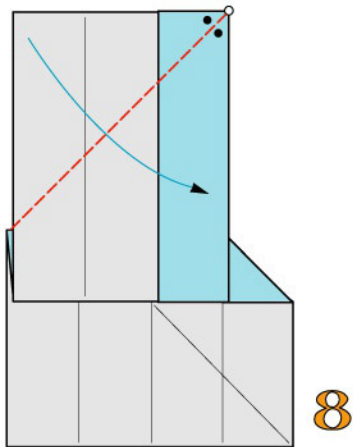

1 piega bisettrice a valle

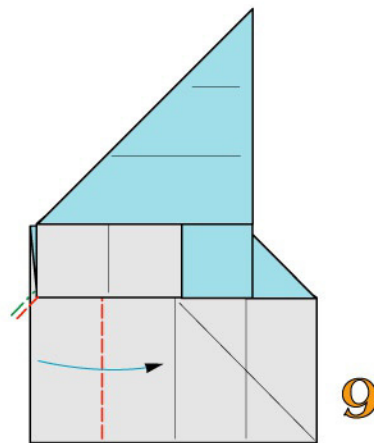

Ripiegate a valle e a monte

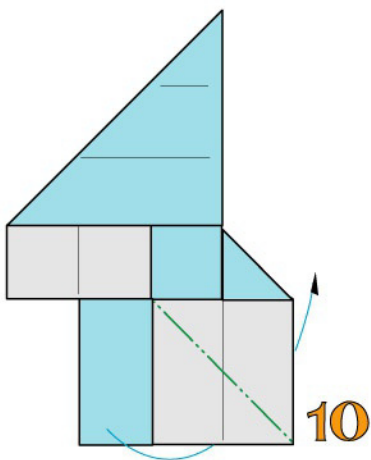

Ripiegate a monte

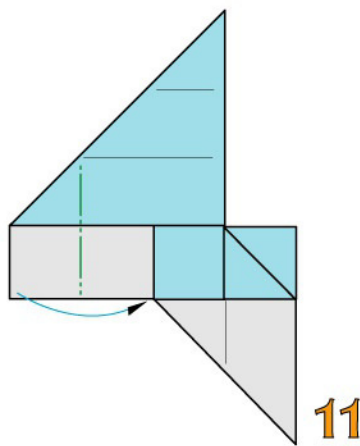

1 piega a monte

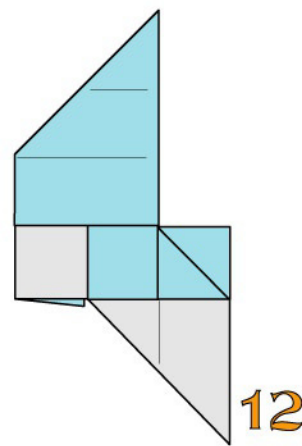

Modulo ultimato

UNIONE DEI MODULI

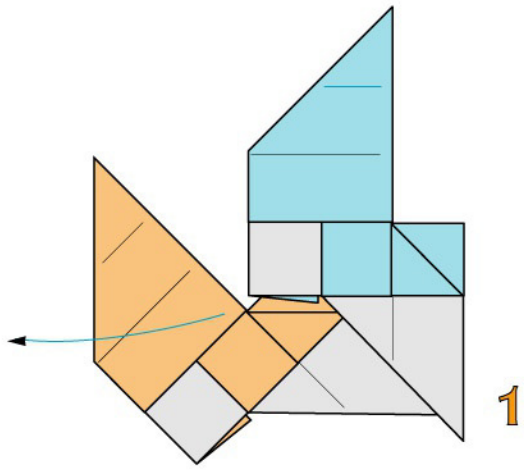

1
Aprite un modulo

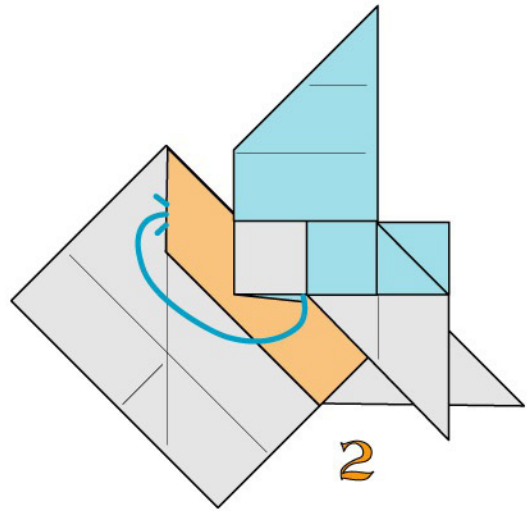

2
Intascate un modulo
nell'altro

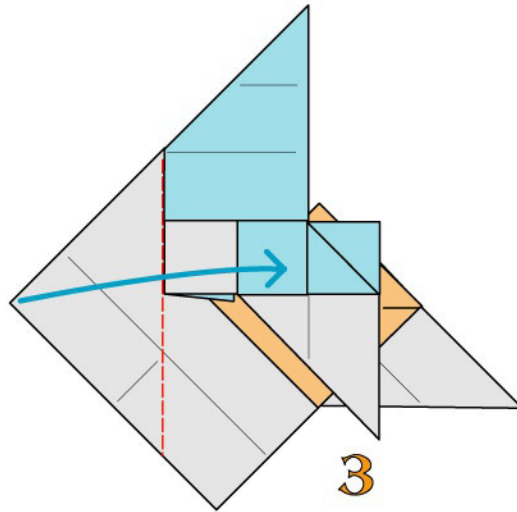

3
Ripiegate a valle

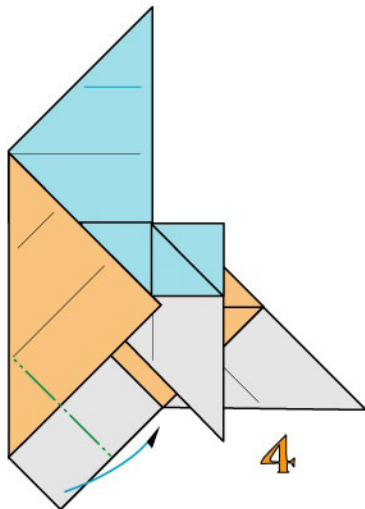

4
Ripiegate a monte

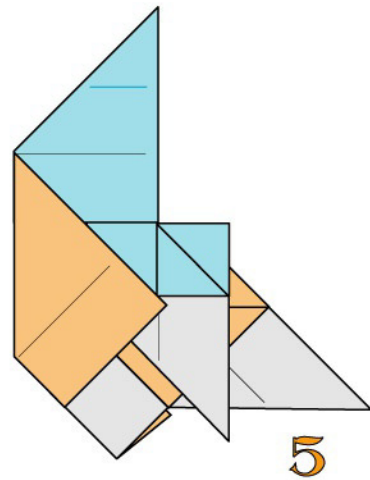

5
Unione completata

GIRANDOLA "A"

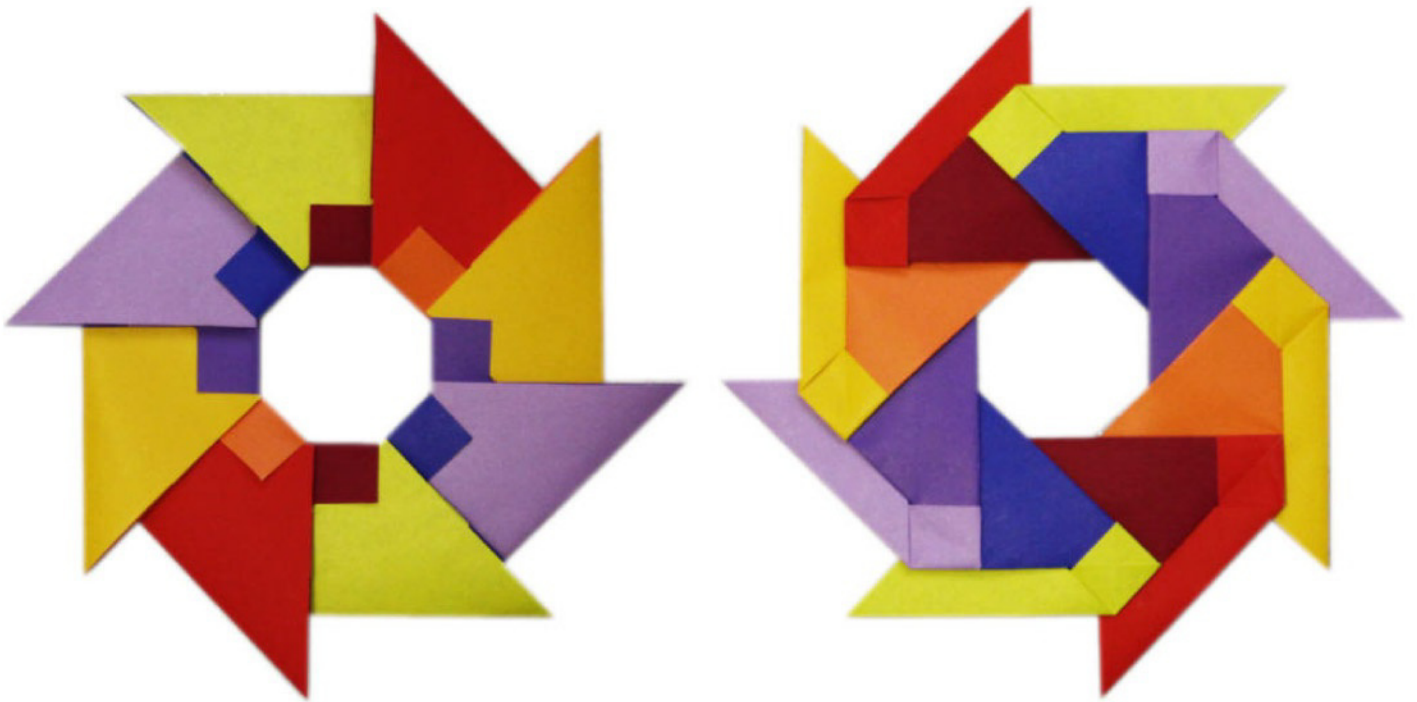

Adoperate 8 mezzi quadrati di carta bicolore

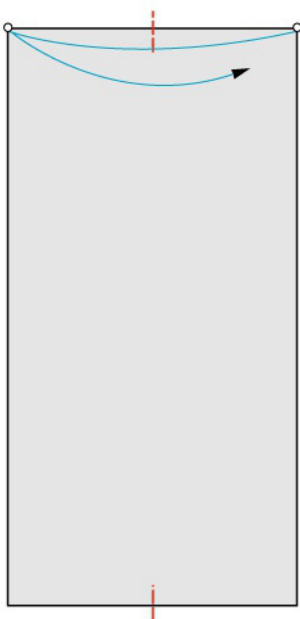

1

2 piccole pieghe a valle



2

1 piega a valle

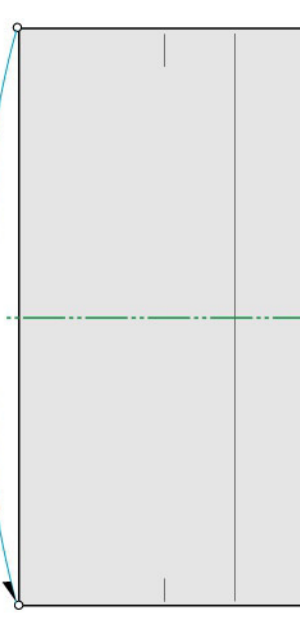

3

1 piega a monte

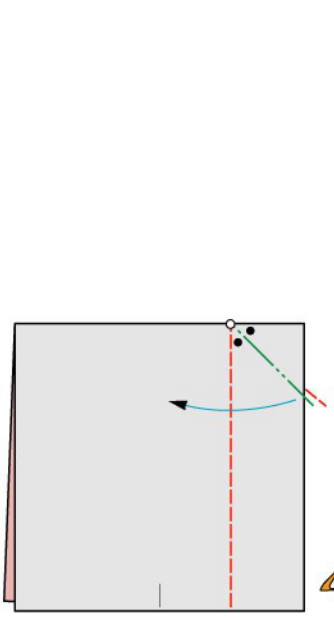

4

1 piega bisettrice a valle,
una bisettrice a monte e
ripiegate

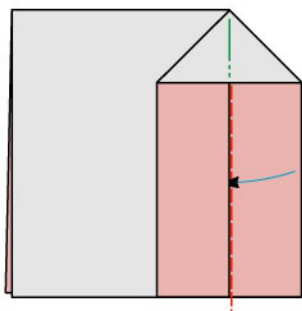

5

Ripiegando a valle e a monte intascate

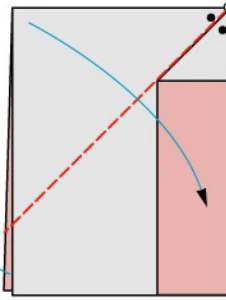

6

1 piega bisettrice a valle

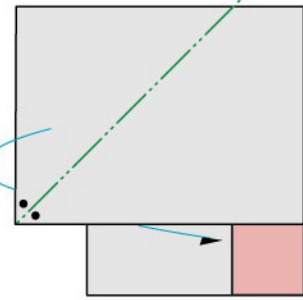

7

1 piega bisettrice a monte

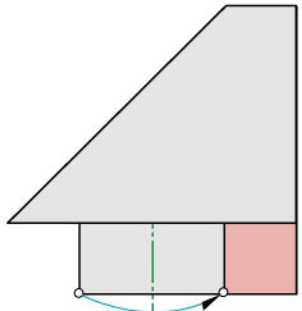

8

1 piega a monte

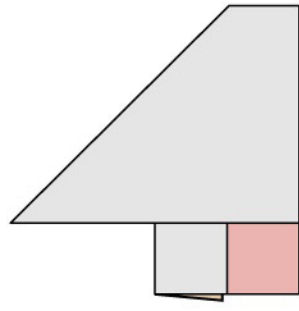

9

Modulo ultimato

UNIONE DEI MODULI

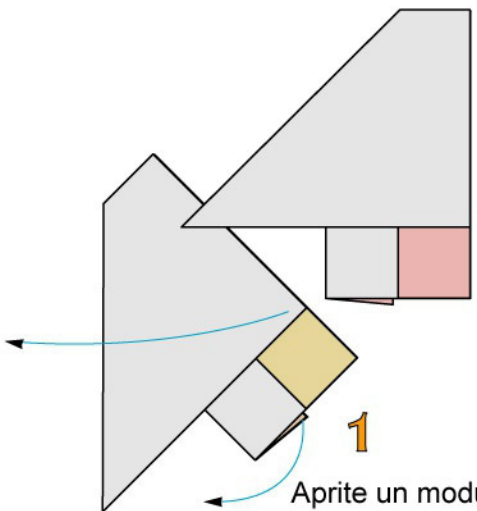

1

Aprire un modulo

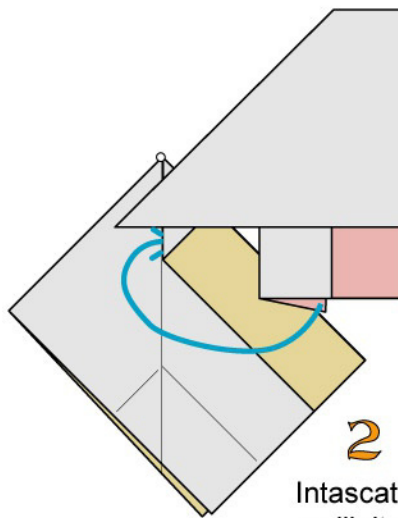

2

Intascate un modulo nell'altro

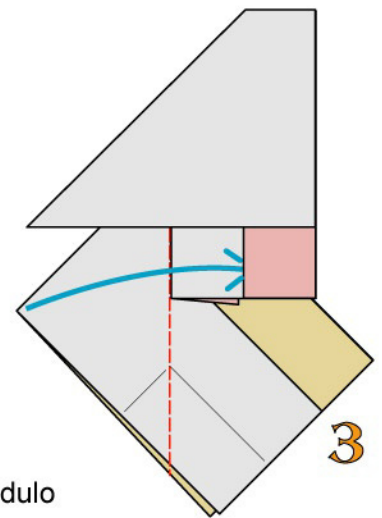

3

Ripiegando a valle intascate

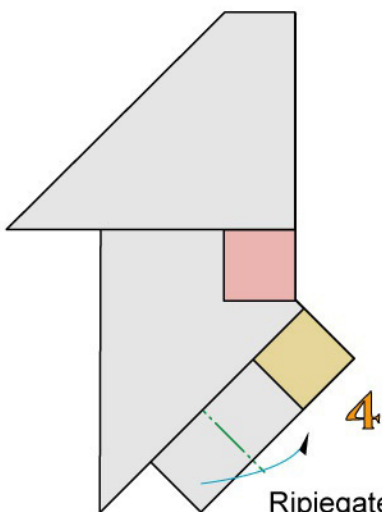

4

Ripiegate a monte

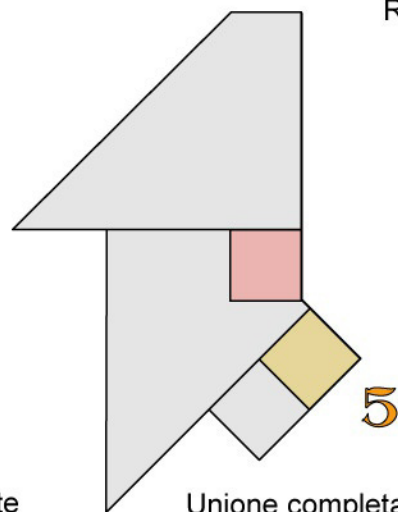

5

Unione completata

GIRANDOLA "B"



Adoperate 8 fogli A4 o frazioni di A4, monocolori o bicolori

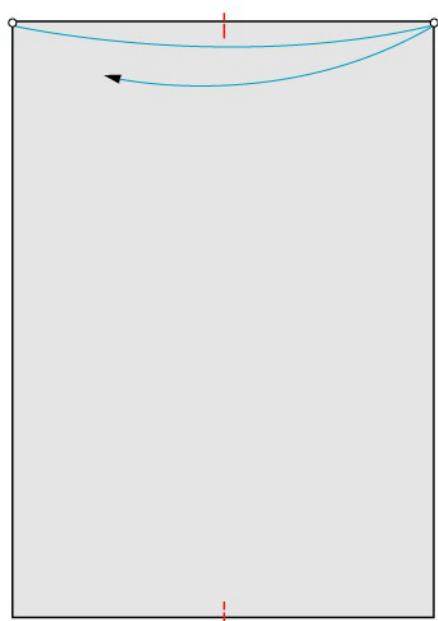

1

2 piccole pieghe a valle

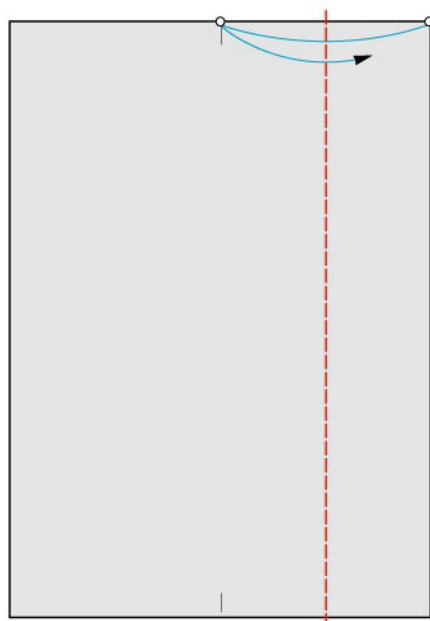

2

1 piega a valle

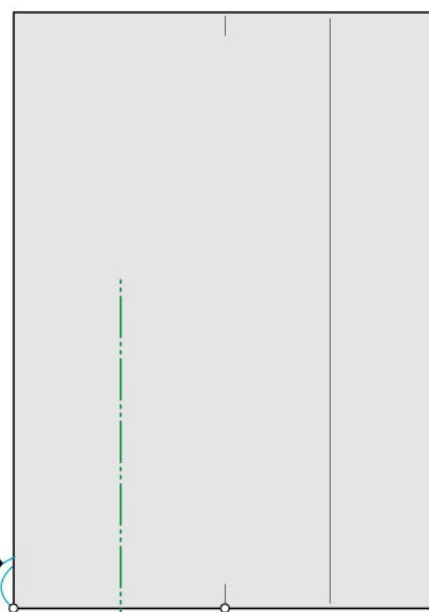

3

1 piega a monte

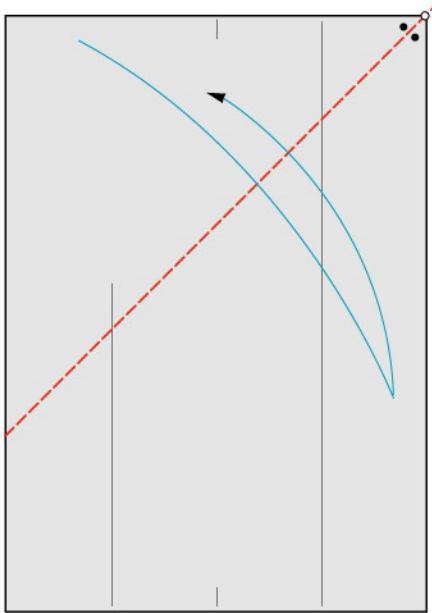

4

1 piega bisettrice a valle

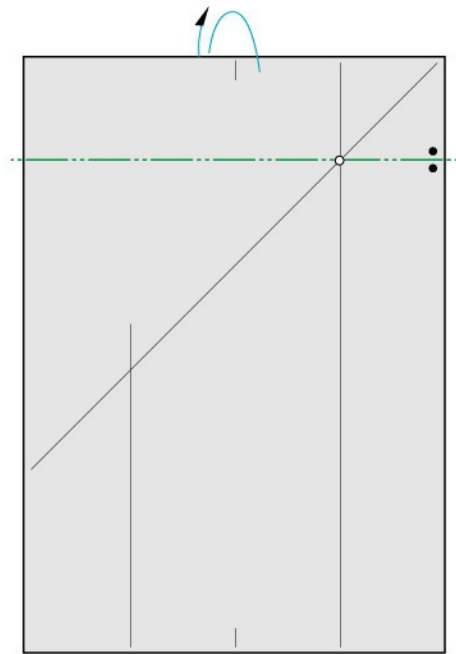

5

1 piega bisettrice a monte

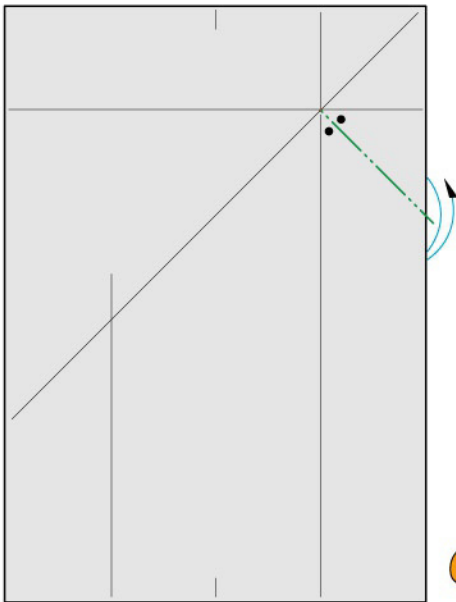

6

1 piega bisettrice a monte

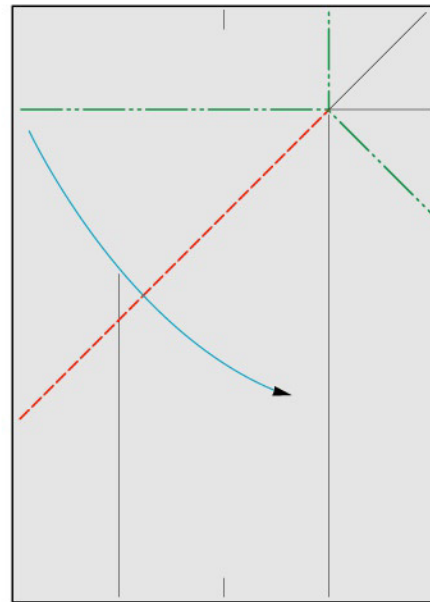

7

Ripiegate a valle e a monte

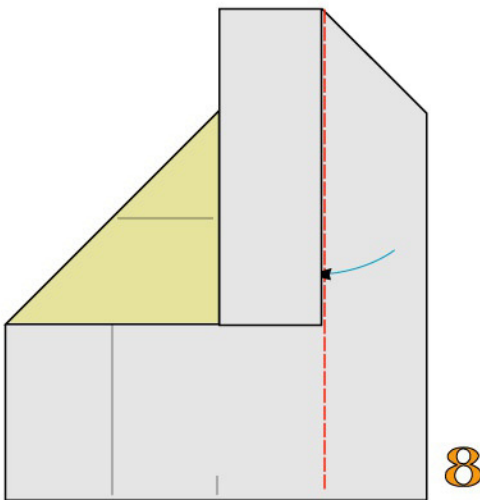

8

Ripiegando a valle intascate

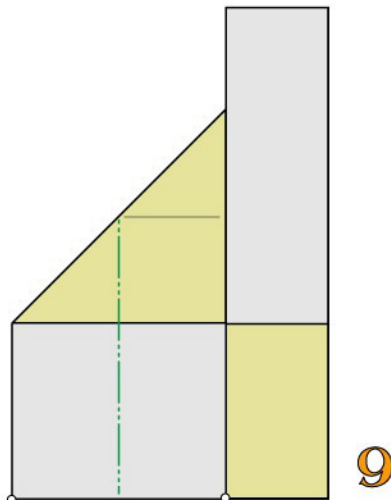

9

Una piega a monte

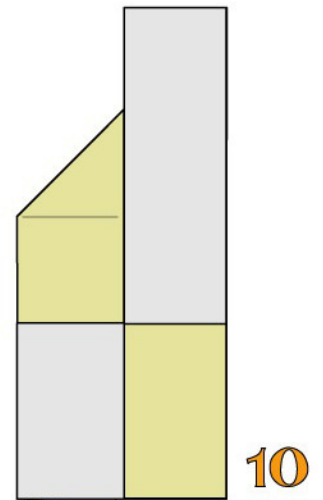

10

Modulo ultimato



UNIONE DEI MODULI

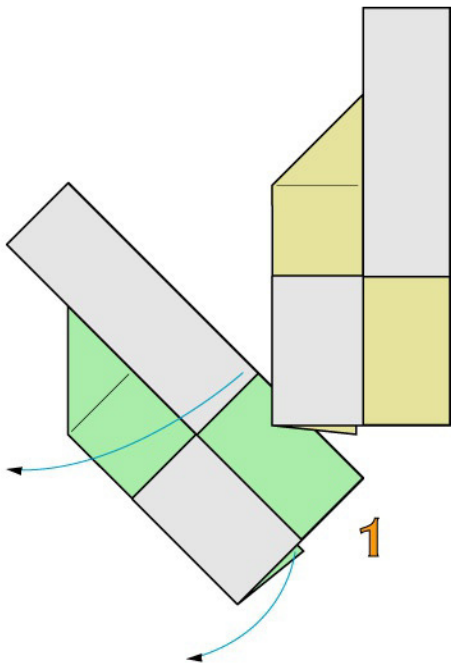

1

Aprire un modulo

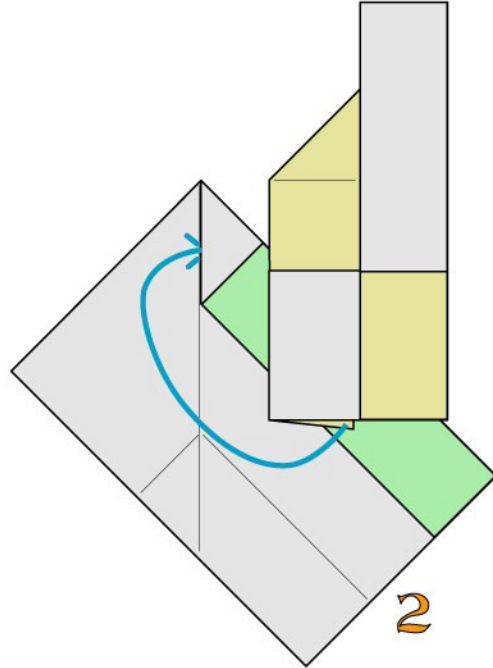

2

Intascate un modulo nell'altro

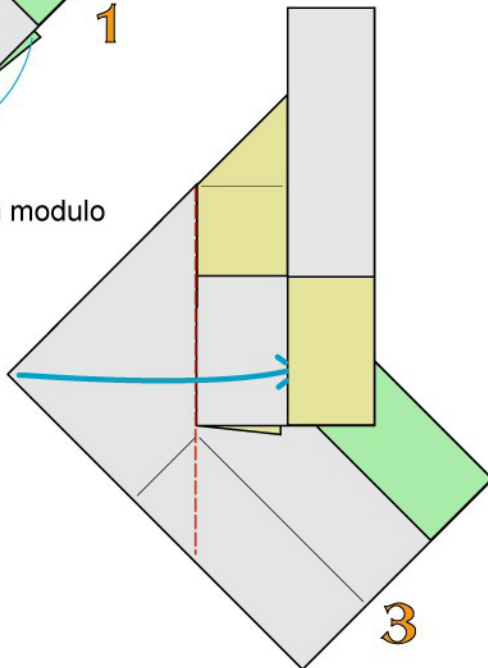

3

Ripiegando a valle intascate

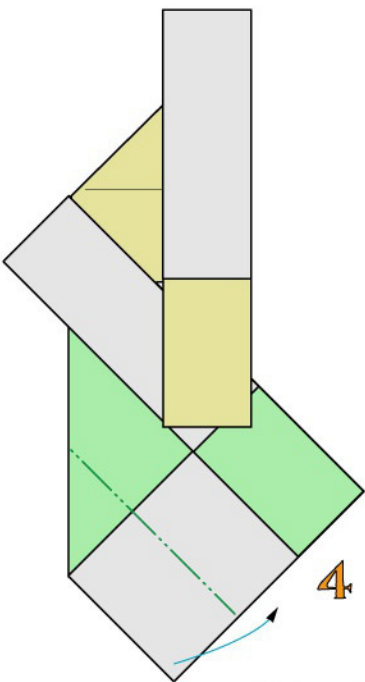

4

Ripiegate a monte

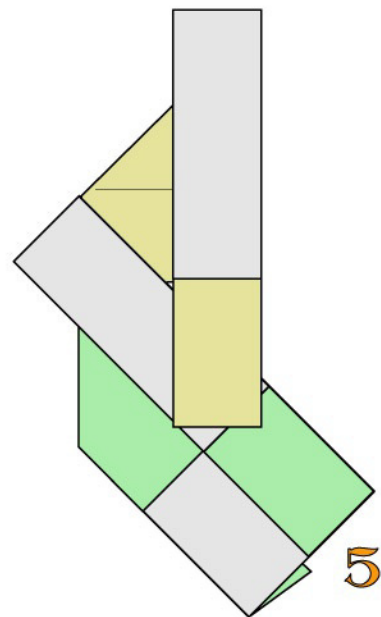

5

Unione completata

GIRANDOLA "C"

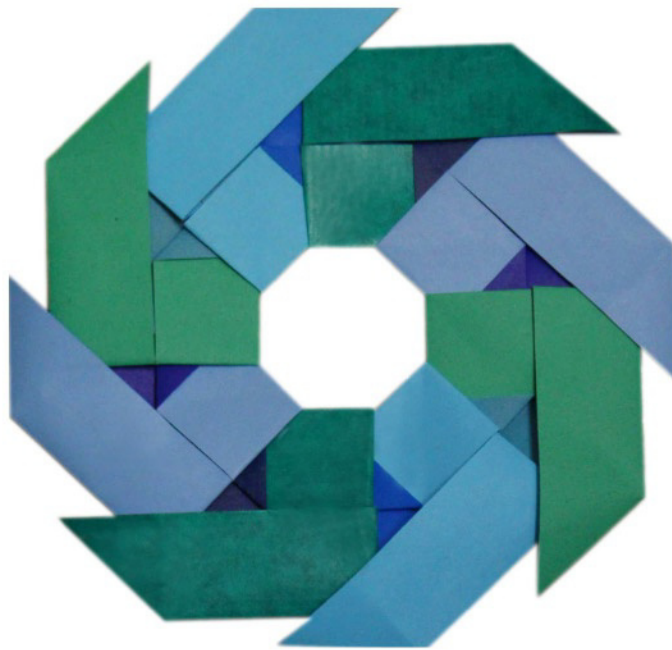

Adoperate 8 fogli quadrati di carta monocolore o bicolore

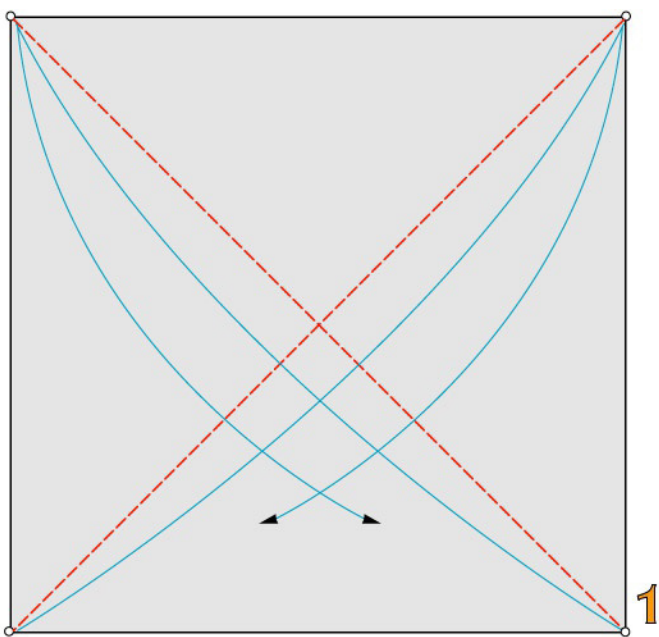

2 pieghe diagonali a valle

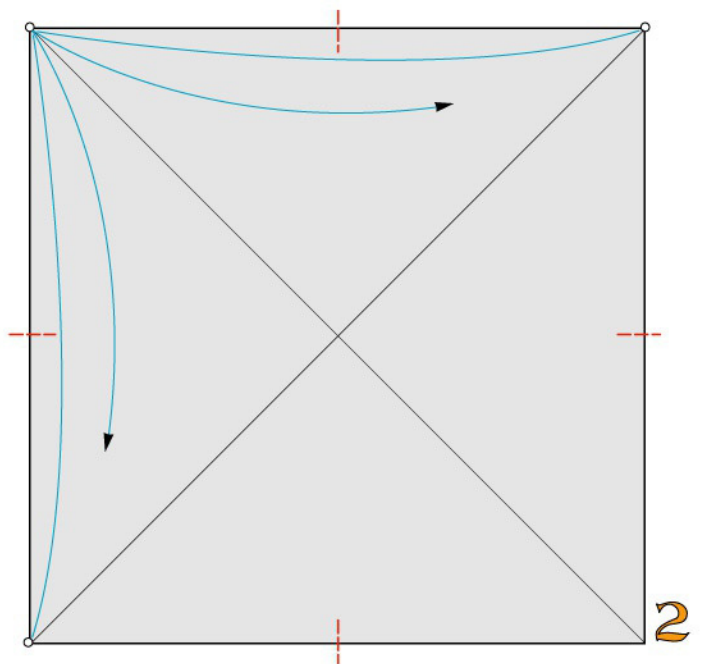

4 piccole pieghe a valle

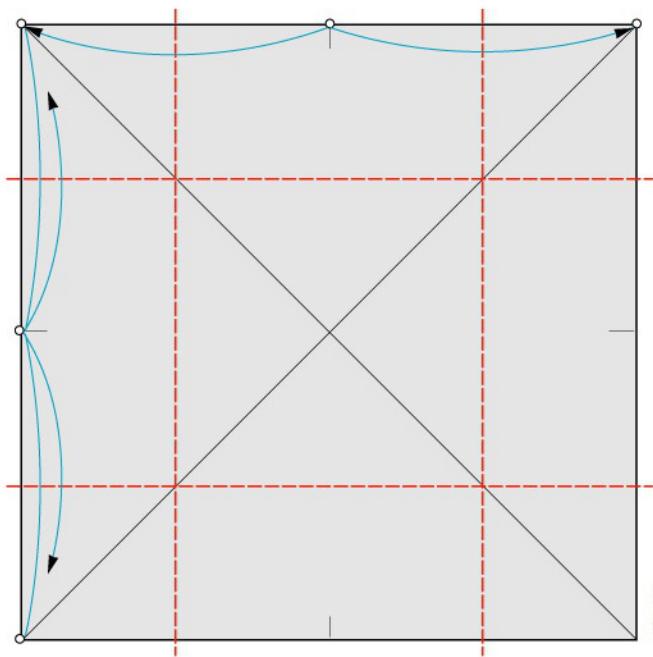

4 pieghe a valle

3

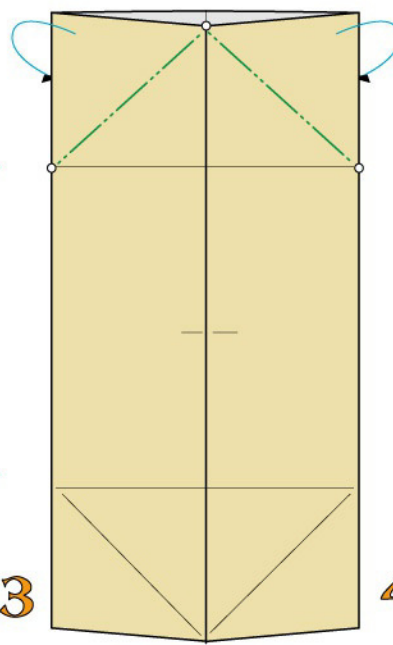

2 pieghe diagonali a monte

4

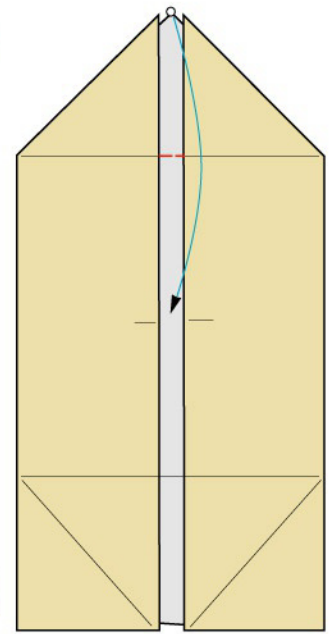

1 piega a valle interna

5

1 piega diagonale a valle

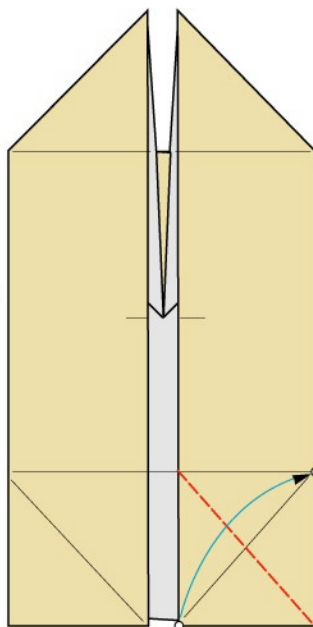

6

1 piega diagonale e
1 bisettrice a valle

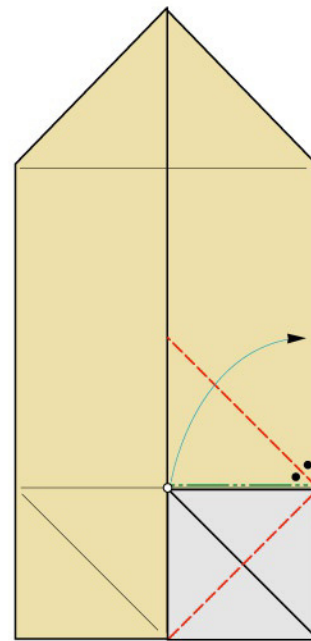

7

Ripiegate a monte

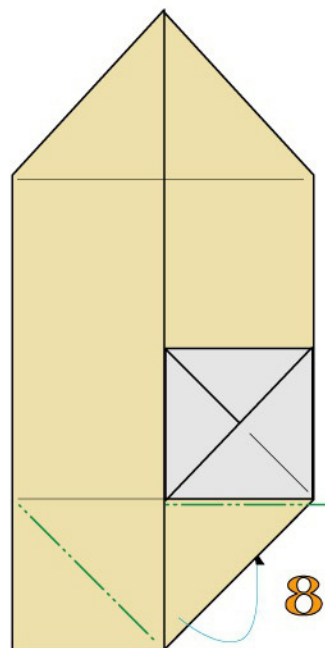

8

Modulo destro ultimato

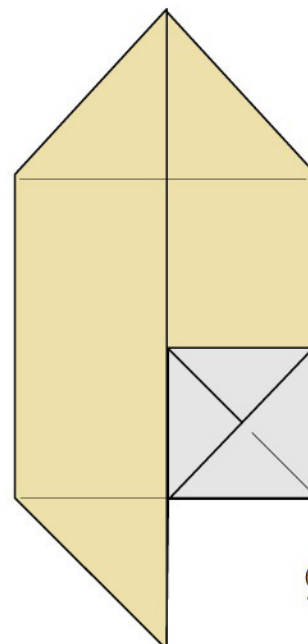

9



UNIONE DEI MODULI

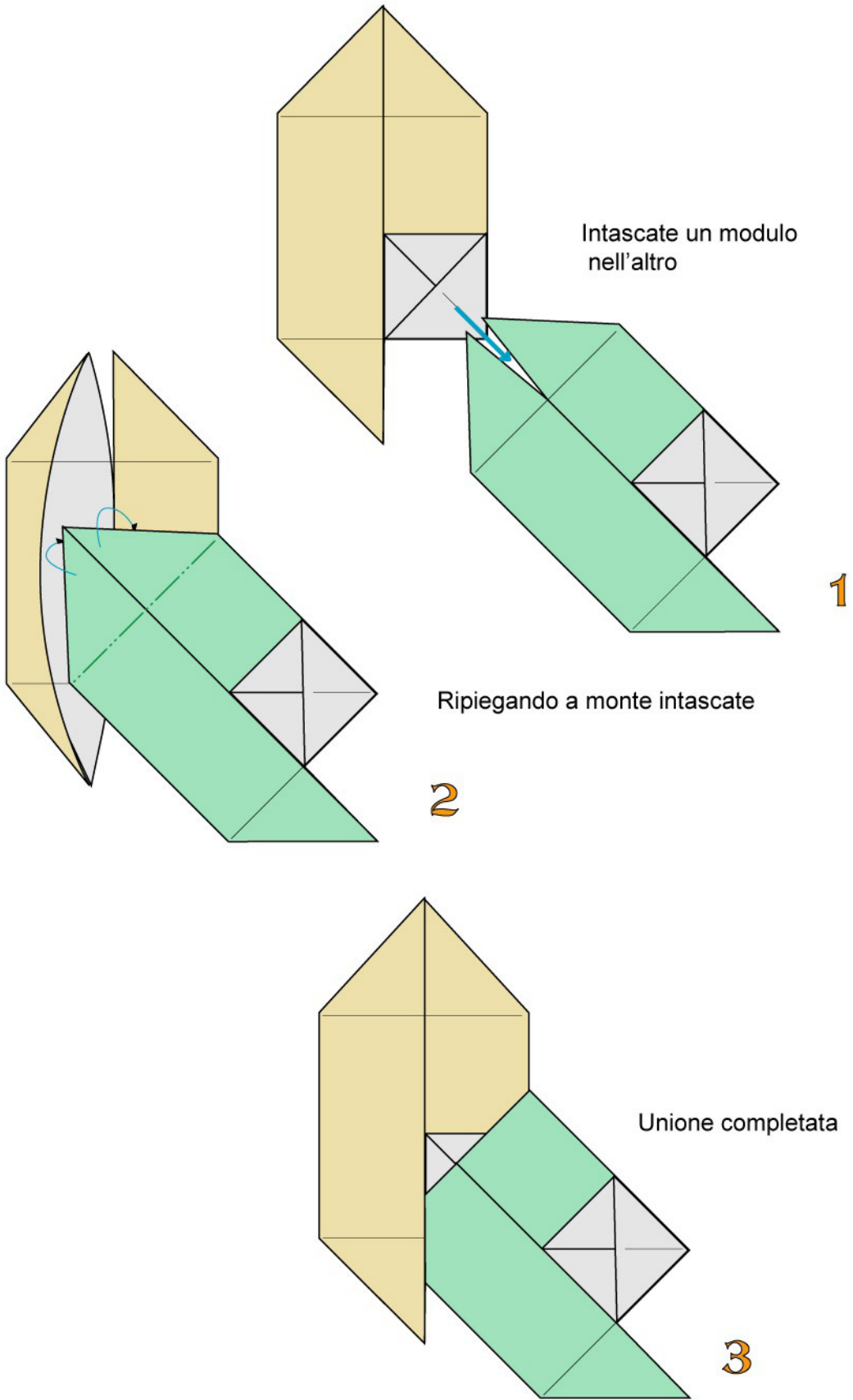

È possibile realizzare un nastro originale unendo alternativamente moduli simmetrici destro e sinistro
 Per realizzare un modulo sinistro partite dalla fig. n.5 del modulo destro

It is possible to make an original tape by alternately joining right and left symmetrical modules.
 To create a left-hand module, start from fig. no. 5 of the right module.

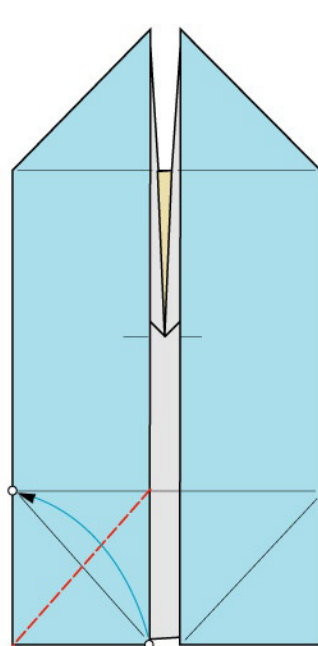

6

1 piega diagonale a valle

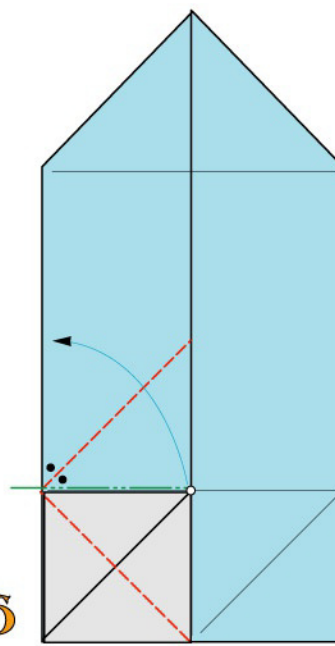

7

1 piega diagonale e
1 bisettrice a valle

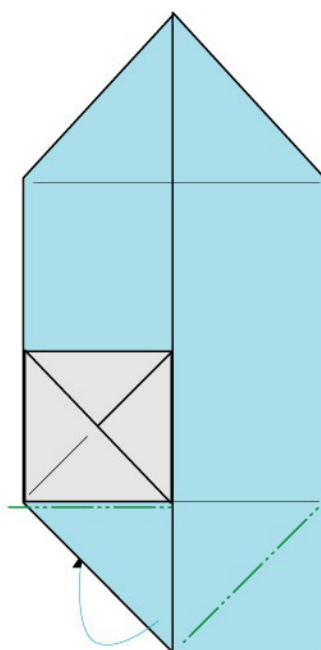

8

Ripiegate a monte

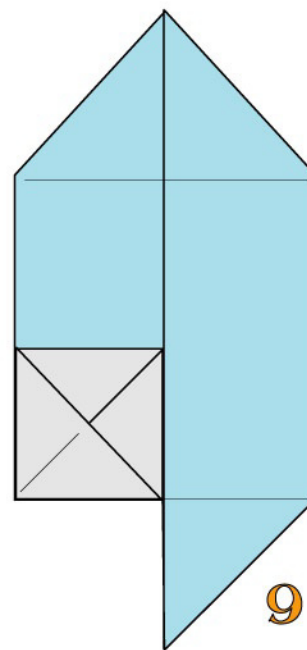

9

Modulo sinistro ultimato

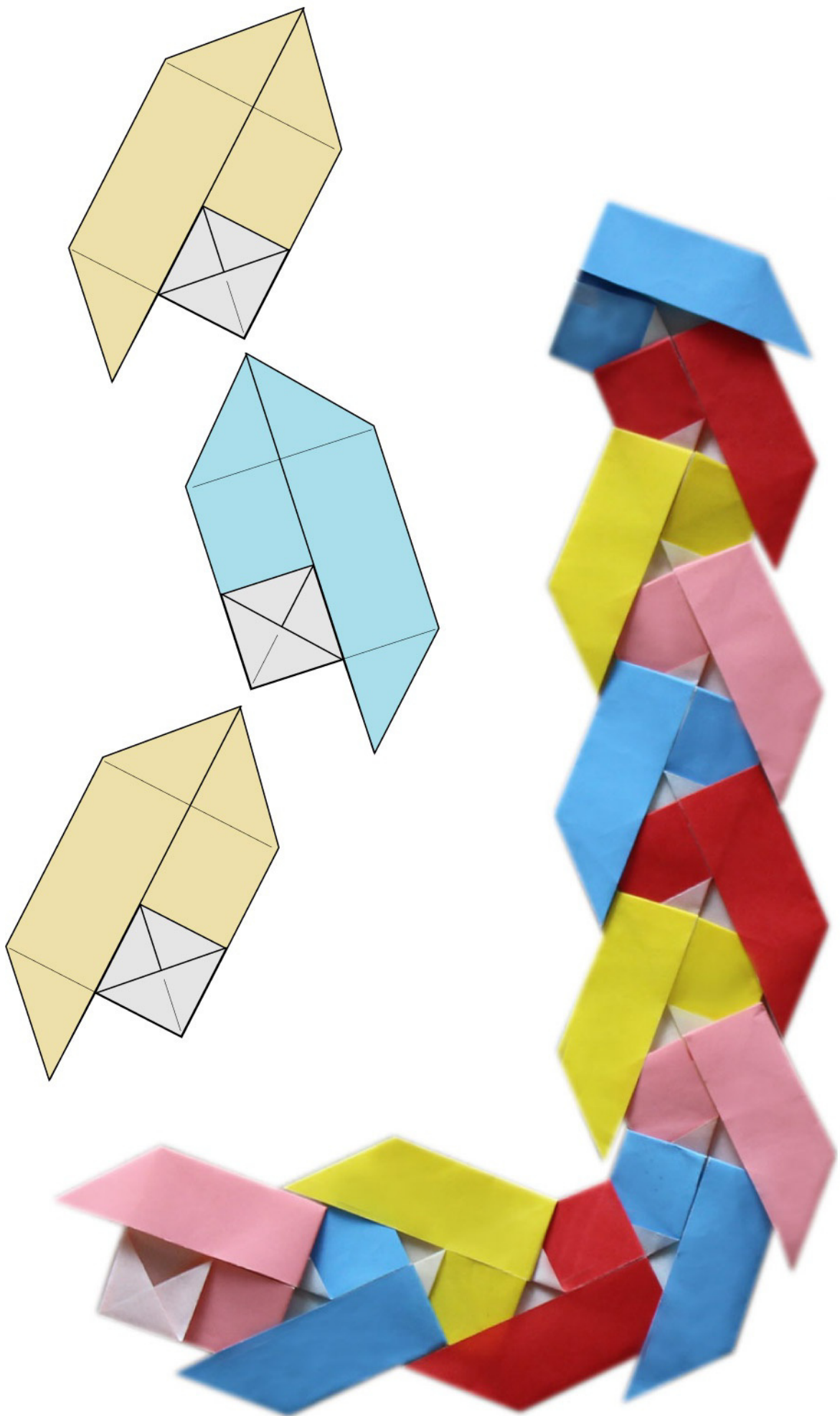

GIRANDOLA "D"

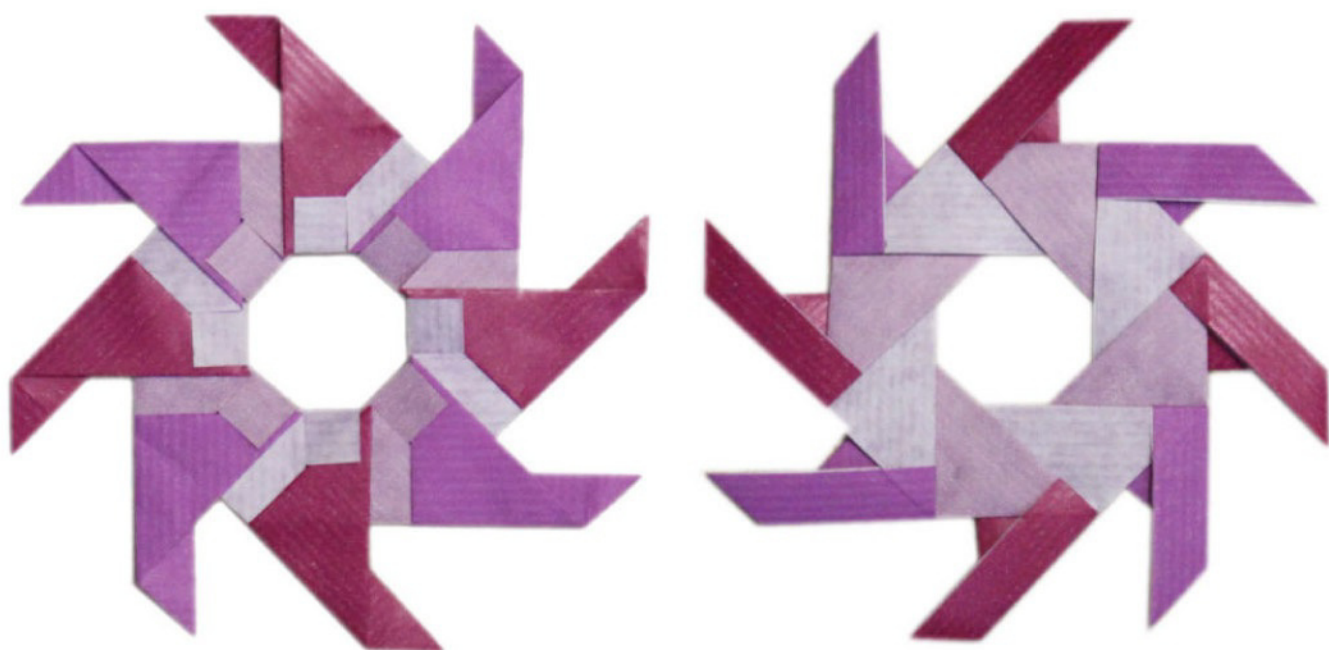

Adoperate 8 mezzi quadrati di carta bicolore

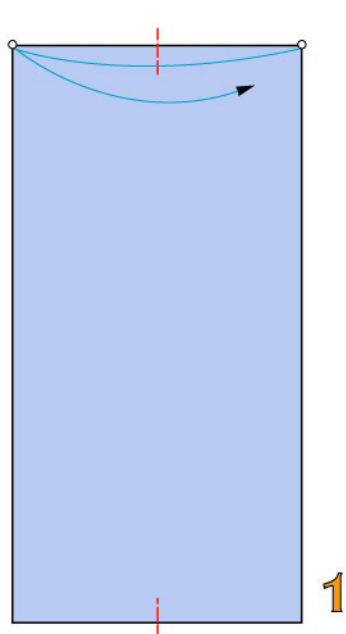

2 piccole pieghe a valle

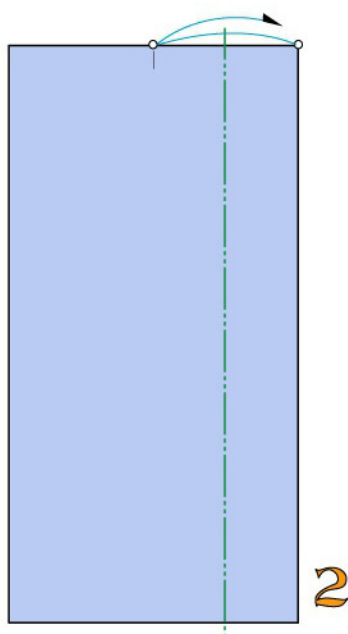

1 piega a monte

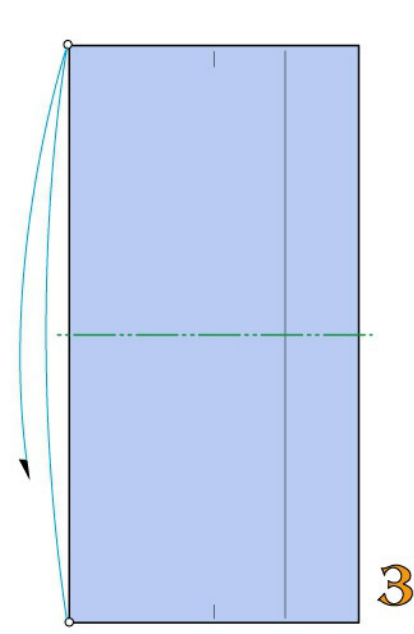

1 piega a monte

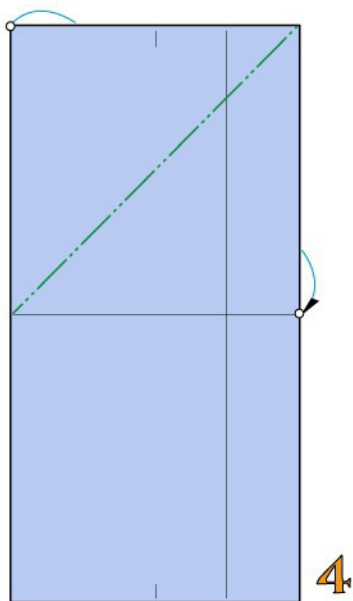

4

1 piega diagonale a monte

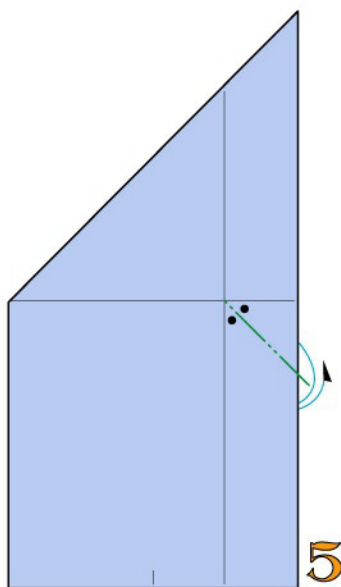

5

1 piega bisettrice a monte

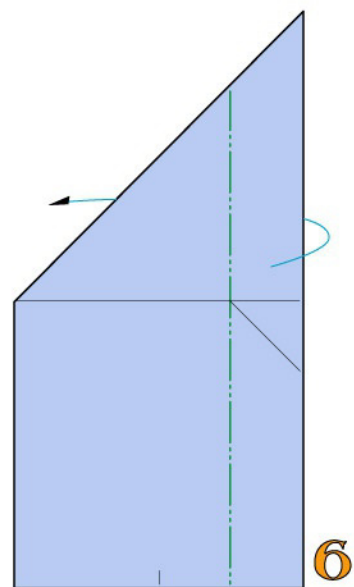

6

1 piega a monte

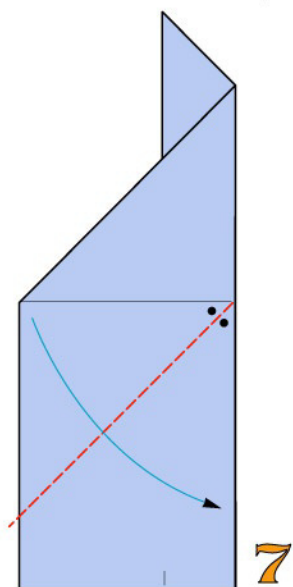

7

1 piega bisettrice a valle

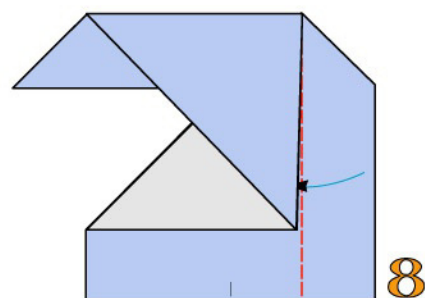

8

Intascate ripiegando a valle

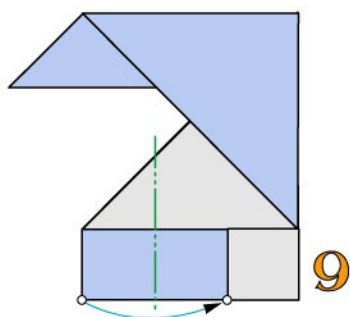

9

1 piega a monte

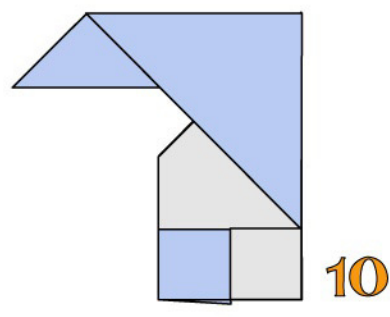

10

Modulo ultimato

UNIONE DEI MODULI

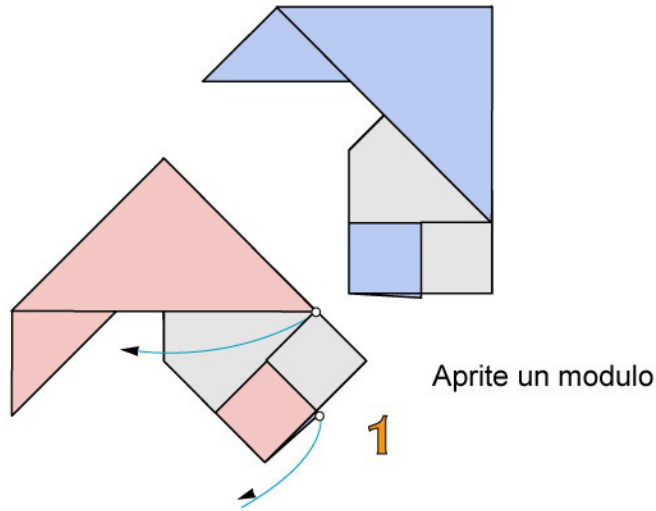

Aprite un modulo

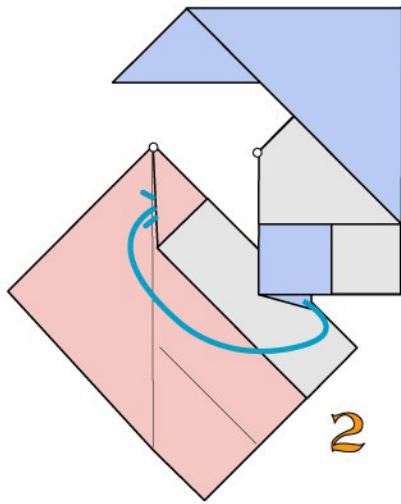

Intascate un modulo nell'altro

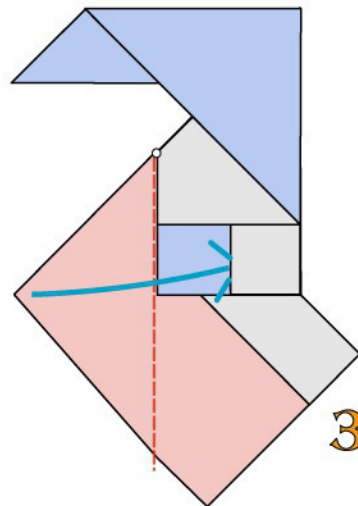

Ripiegando a valle intascate

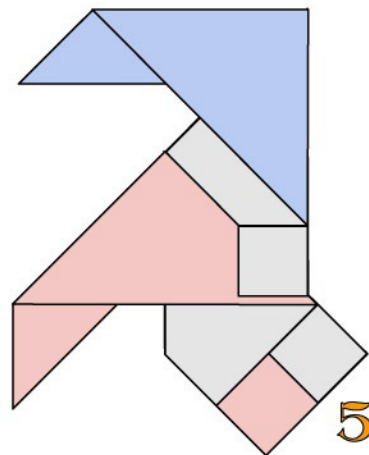
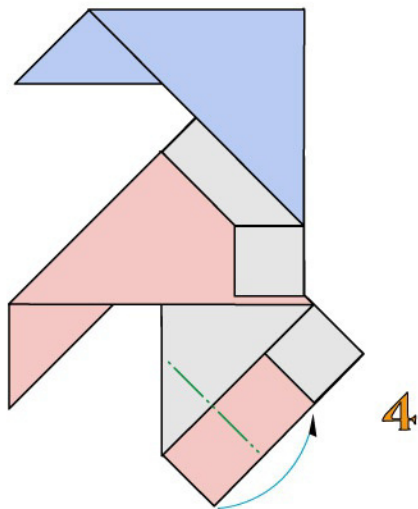

Unione completata

GIRANDOLA "€"

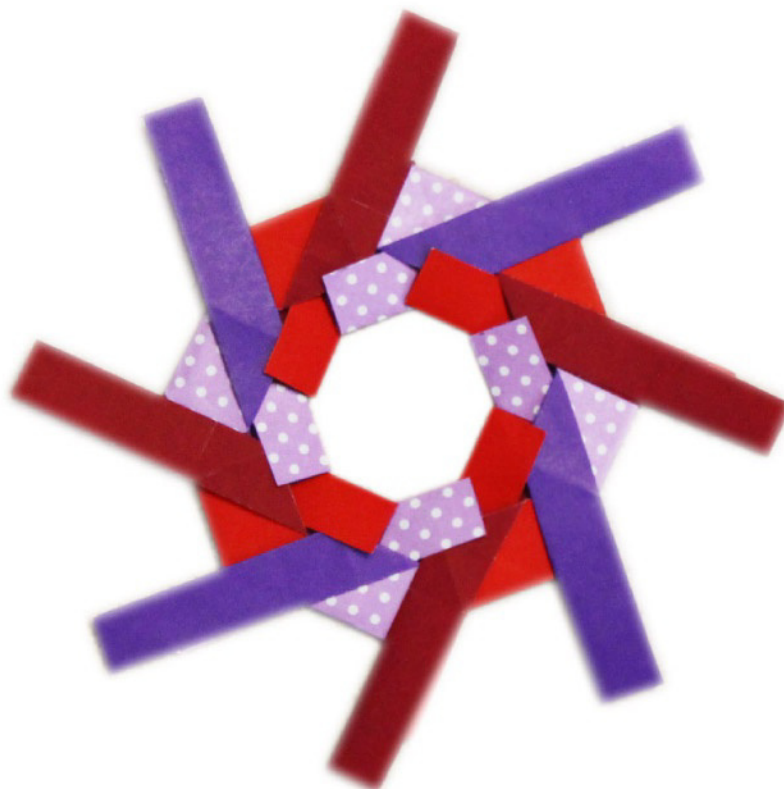

Adoperate 8 mezzi quadrati di carta bicolore

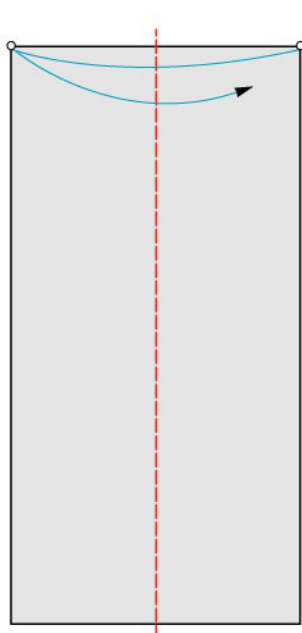

1 piega a valle

1

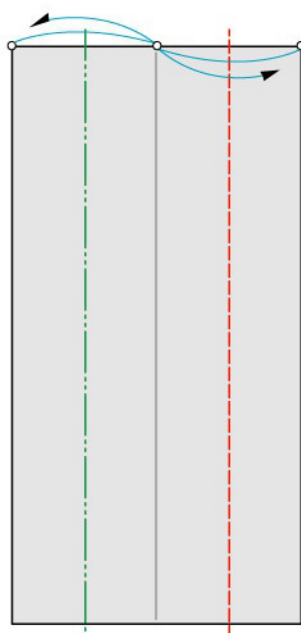

1 piega a valle e 1 a monte

2

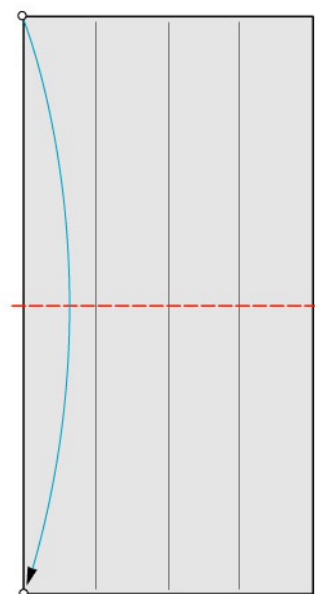

1 piega a valle

3

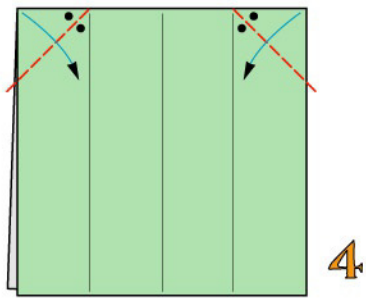

2 pieghe bisettrici a valle

4

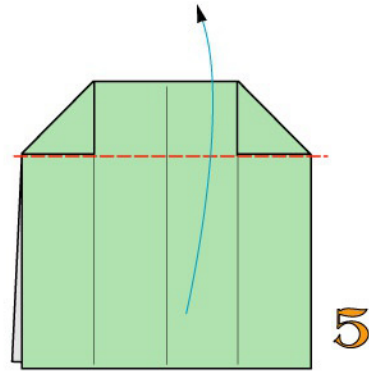

1 piega a valle

5

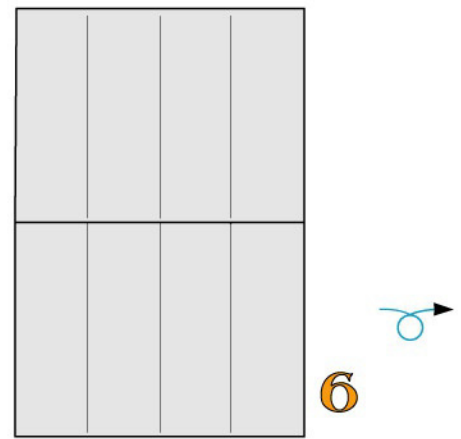

Ribaltate

6

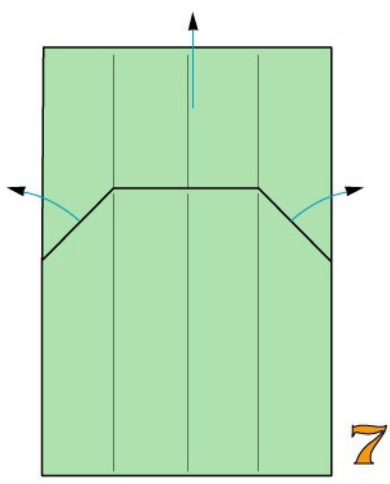

Aprite

7

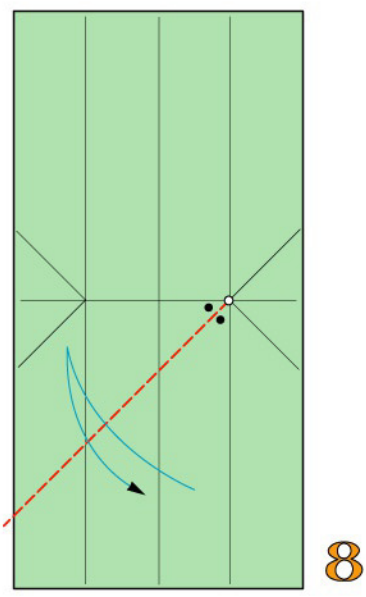

1 piega bisettrice a valle

8

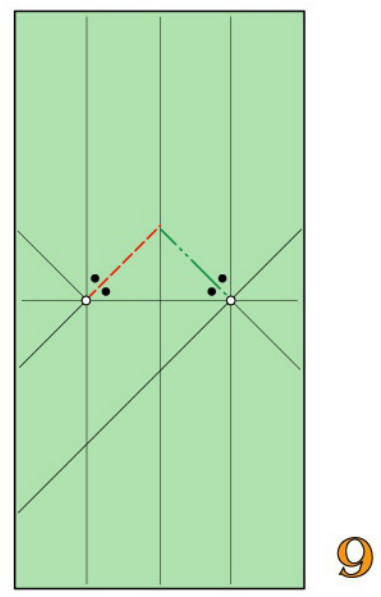

1 piega bisettrice a valle e 1 a monte

9

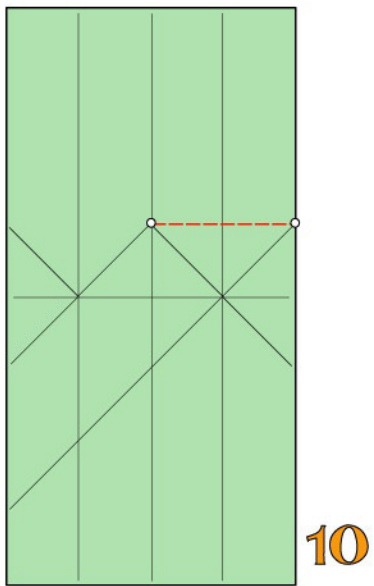

1 piega a valle

10

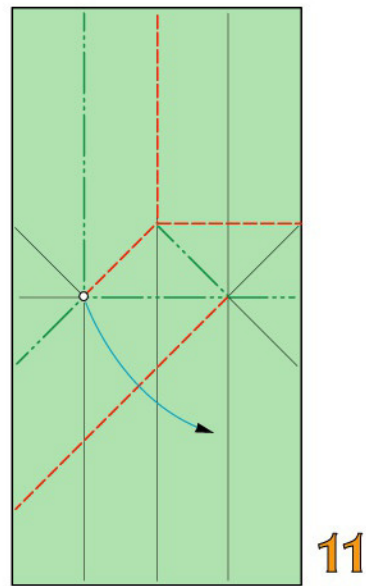

Ripiegate a valle e a monte

11

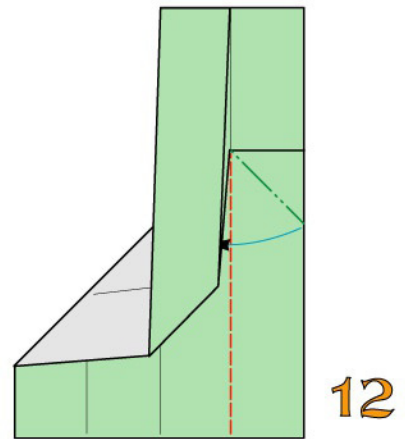

Ripiegando a valle e a monte intascate

12

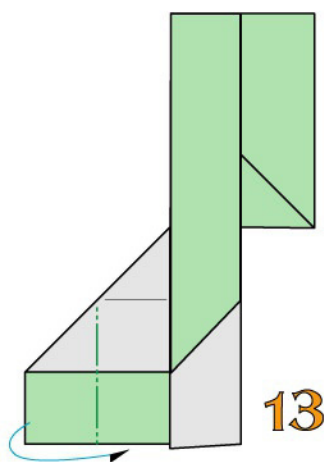

13

1 piega a monte

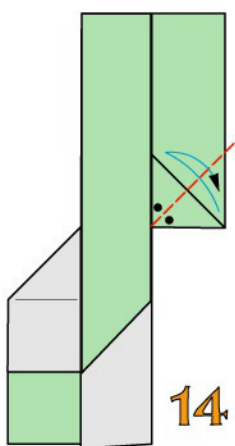

14

1 piega a valle

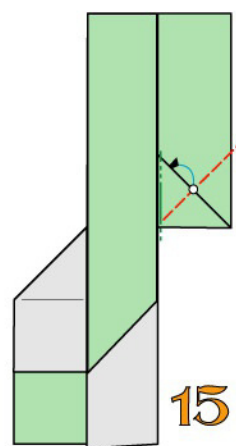

15

1 piega rovescia interna

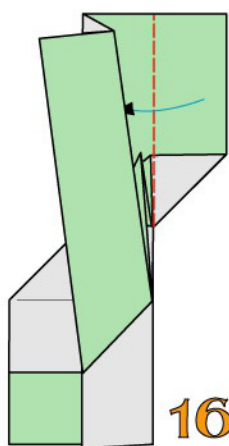

16

Ripiegando a valle intascate

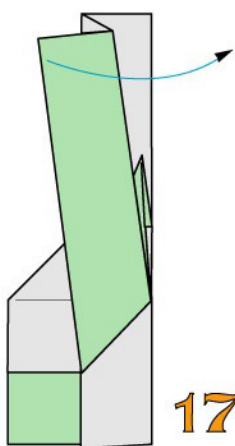

17

Aprite

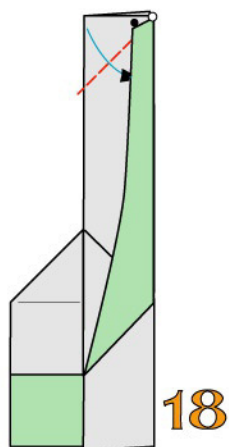

18

1 piega a valle

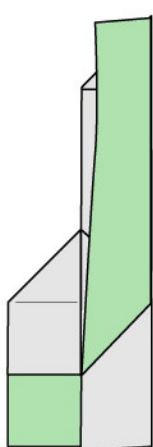

19

Modulo ultimato



UNIONE DEI MODULI

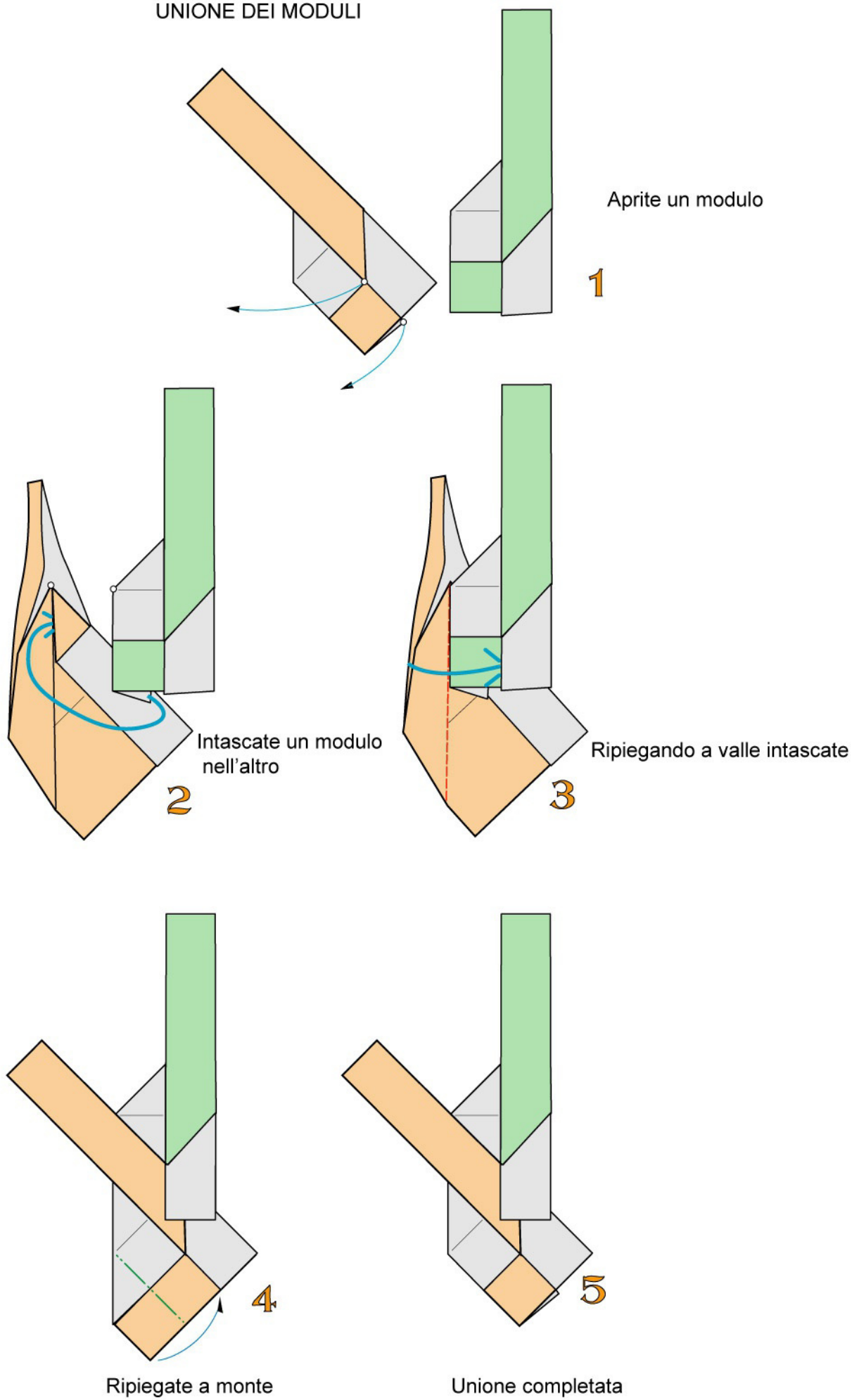

GIRANDOLA "F"

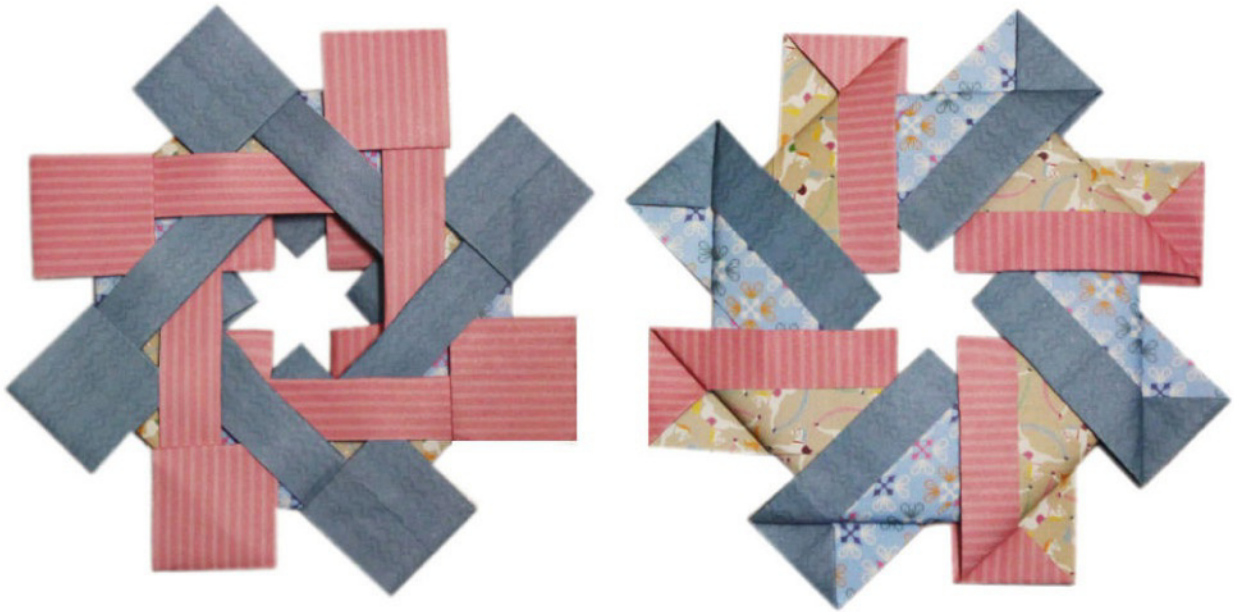

Adoperate 8 mezzi quadrati di carta bicolore

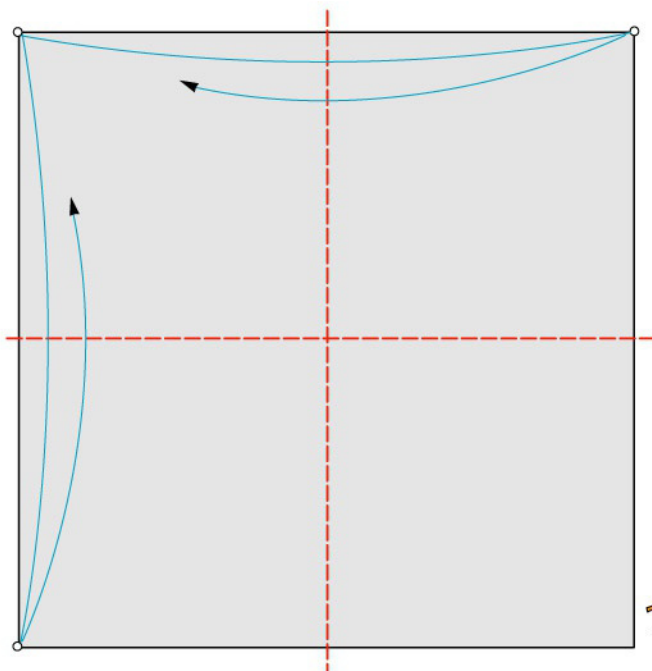

2 pieghe a valle

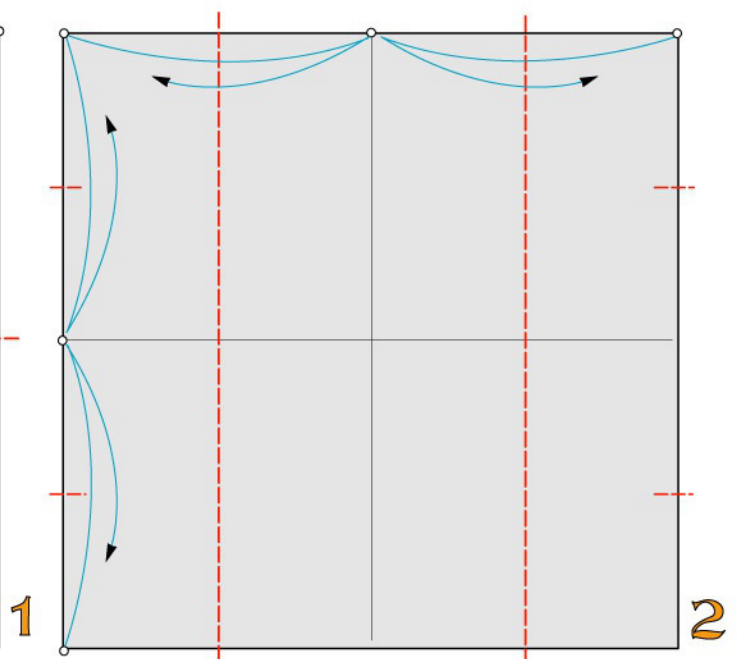

6 pieghe a valle, di cui 4 piccole

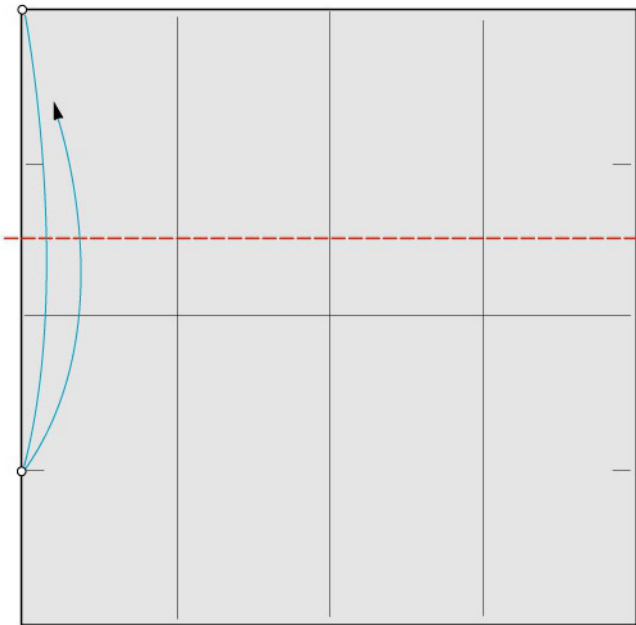

3

1 piega a valle

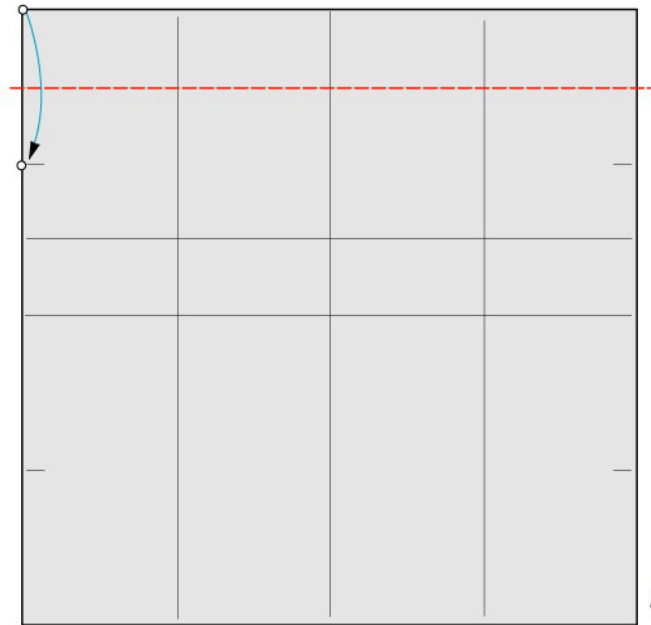

4

1 piega a valle

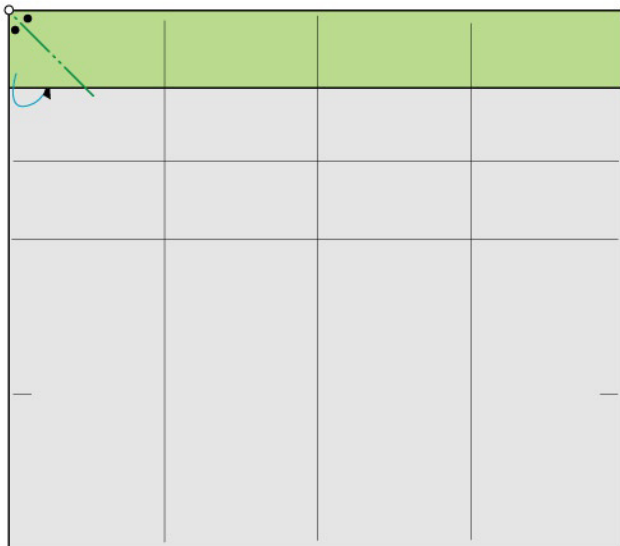

5

1 piega bisettrice a monte e ribaltate

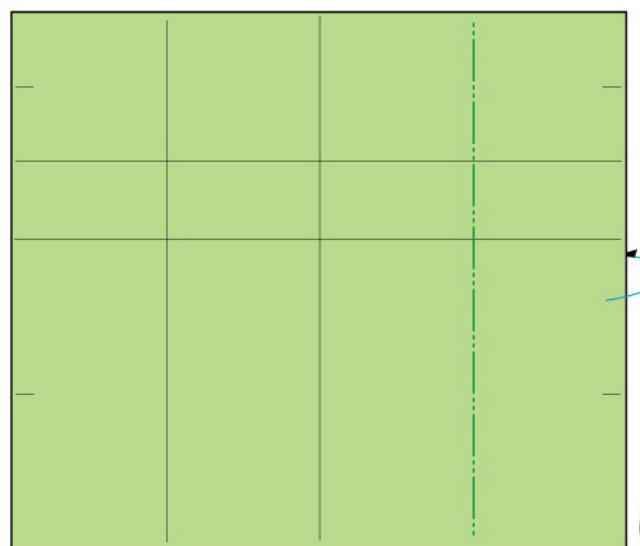

6

1 piega a monte

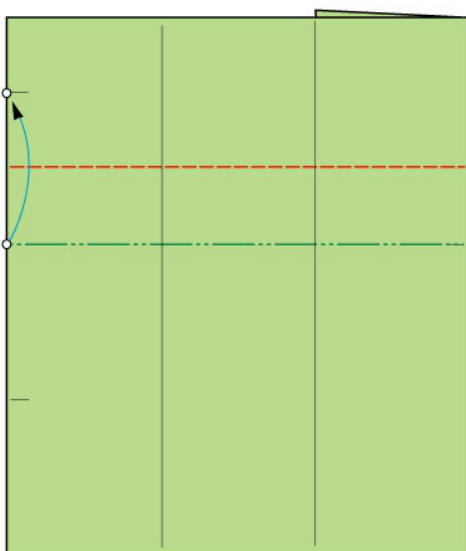

7

Ripiegate a valle e a monte

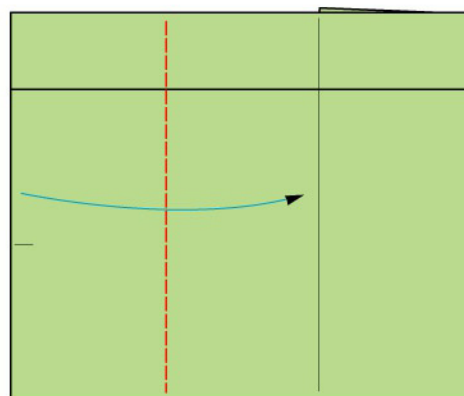

1 piega a valle

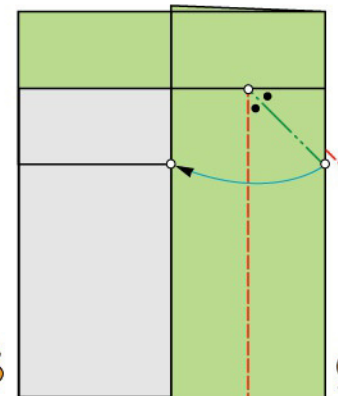

9

2 pieghe a valle e 1 a monte

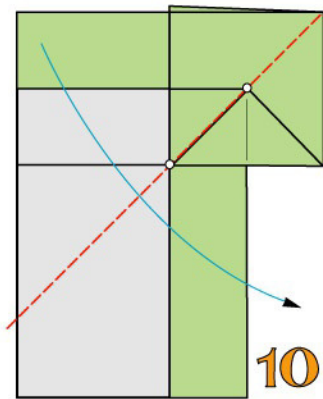

1 piega a valle

10

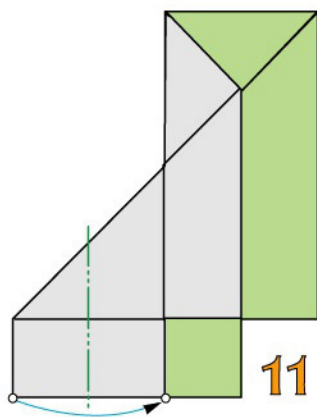

1 piega a monte

11

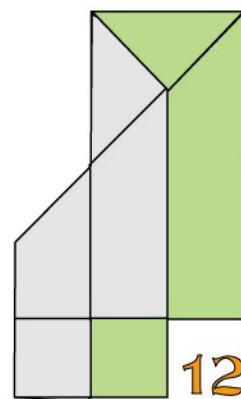

Modulo ultimato

12



UNIONE DEI MODULI

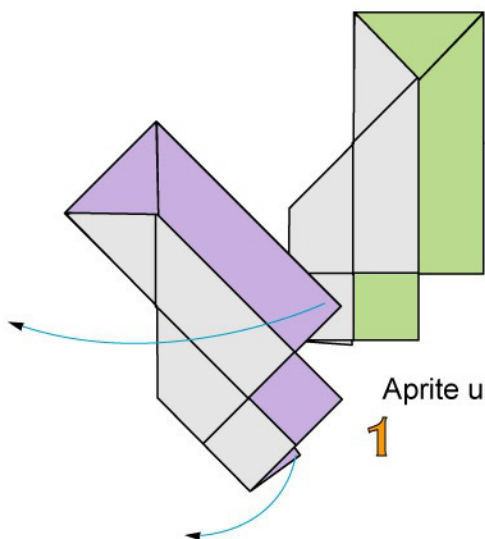

Aprite un modulo

1

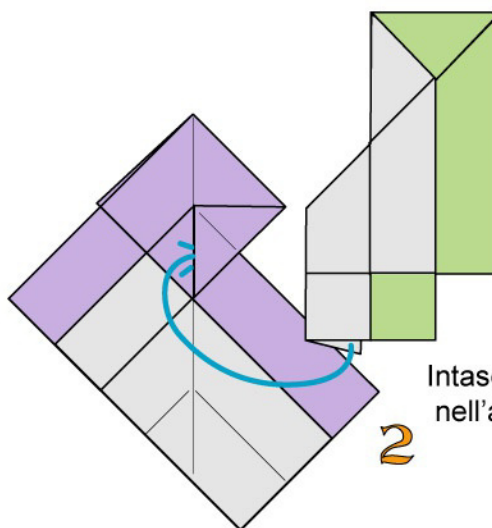

Intascate un modulo nell'altro

2

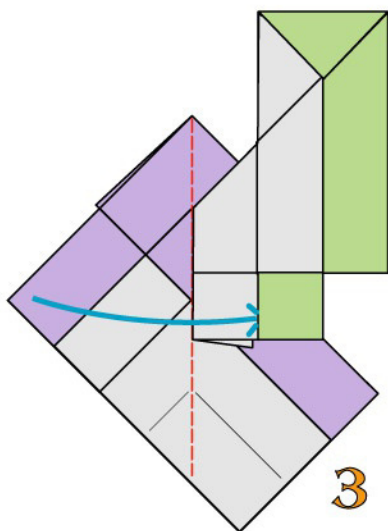

Ripiegando a valle intascate

3

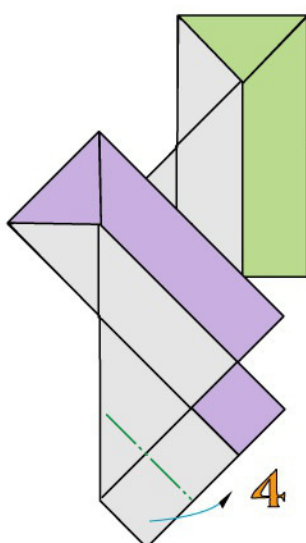

Ripiegate a monte

4

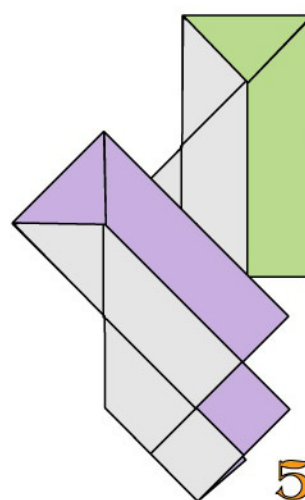

Unione completata

5

GIRANDOLA "G"



Adoperate 8 mezzi quadrati di carta bicolore

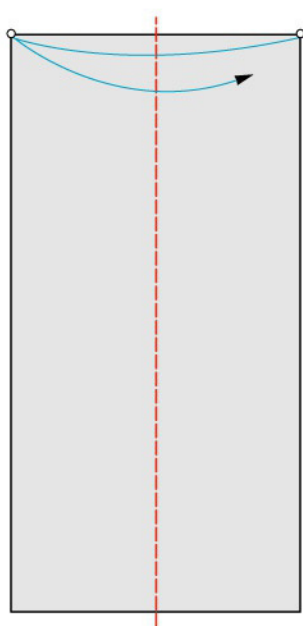

1

1 piega a valle

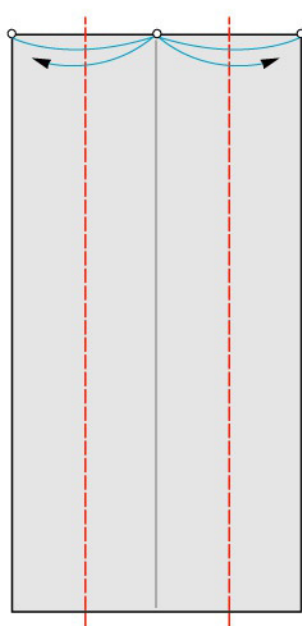

2

2 pieghe a valle

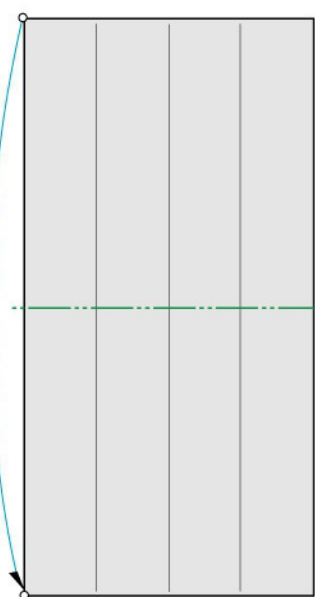

3

1 piega a monte

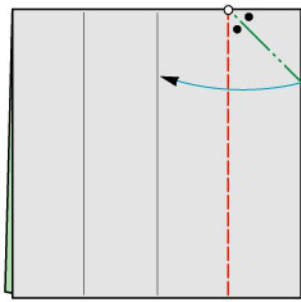

4

2 pieghe a valle e 1 a monte

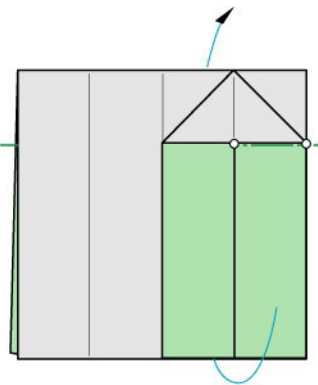

5

1 piega a monte

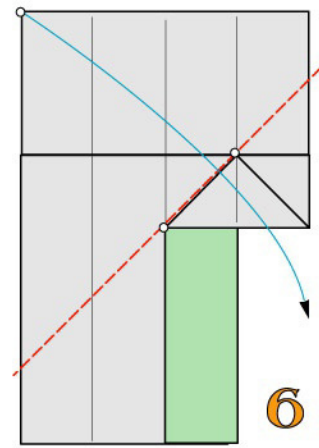

6

1 piega a valle

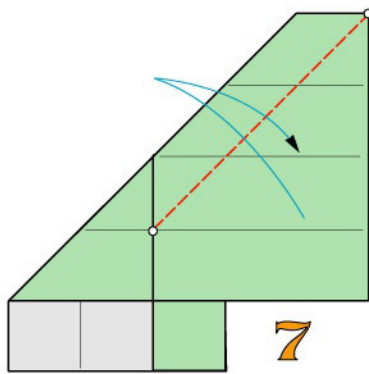

7

1 piega a valle

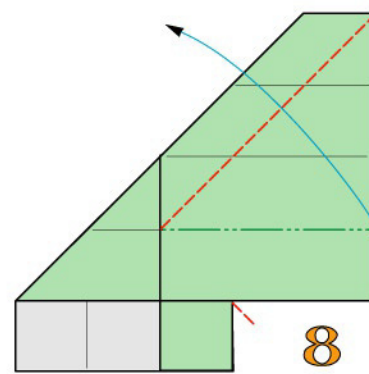

8

Ripiegate a valle e a monte

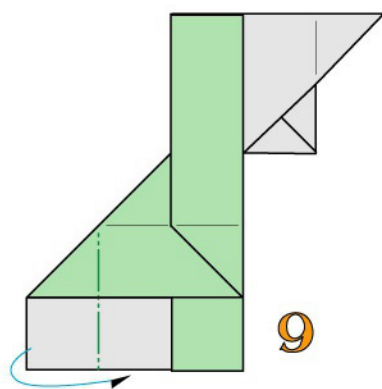

9

1 piega a monte

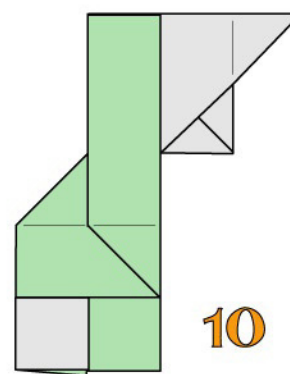

10

Modulo ultimato

UNIONE DEI MODULI

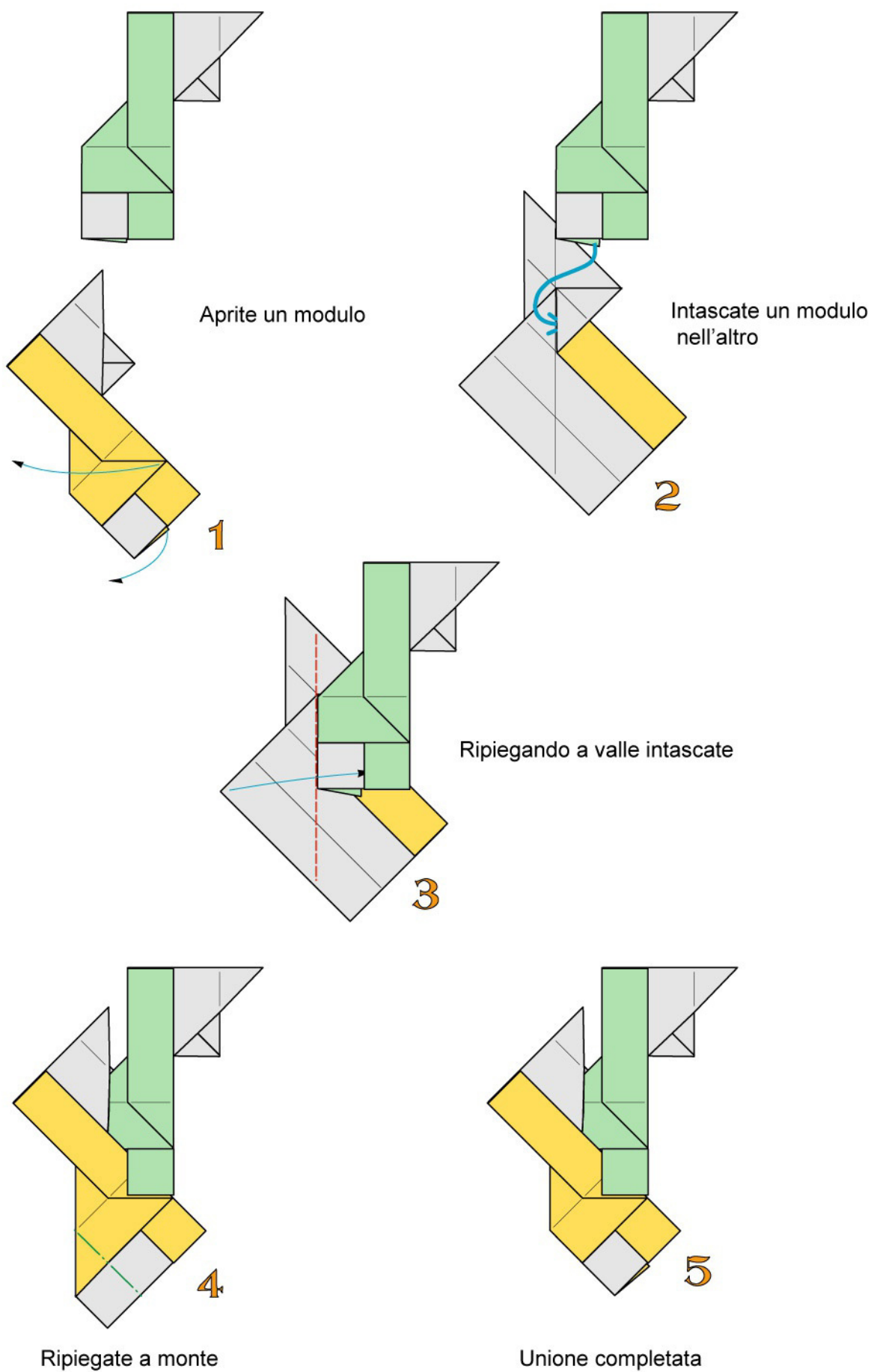

GIRANDOLA "H"

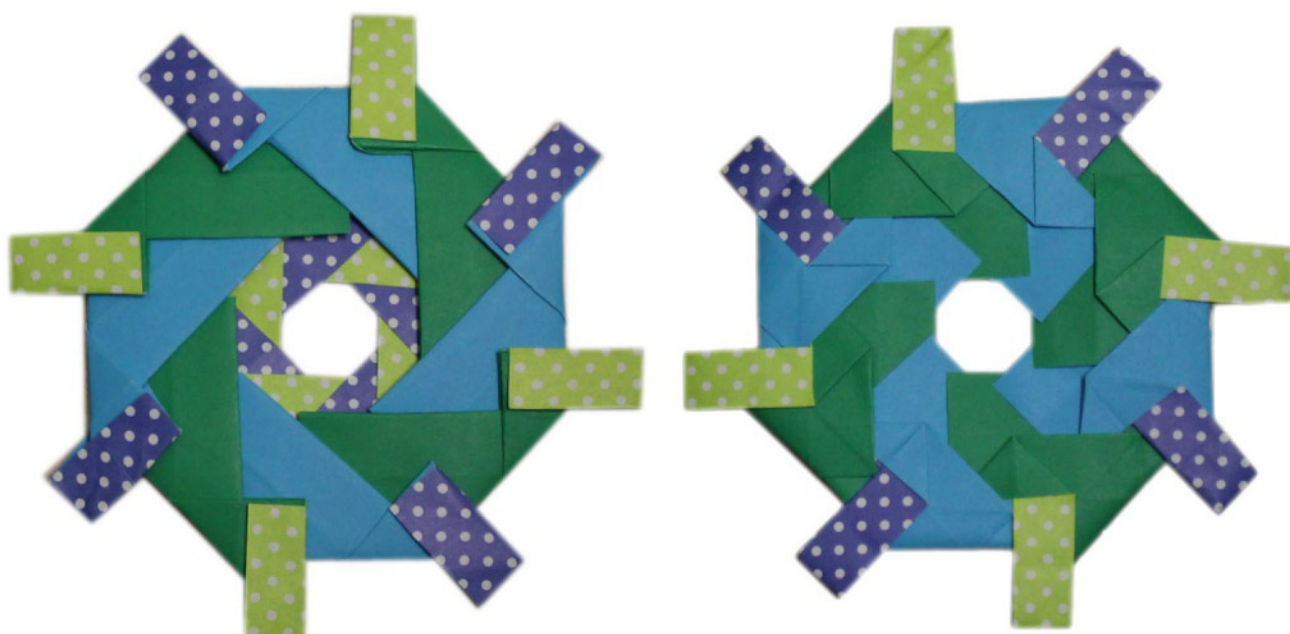

Adoperate 8 fogli quadrati di carta bicolore

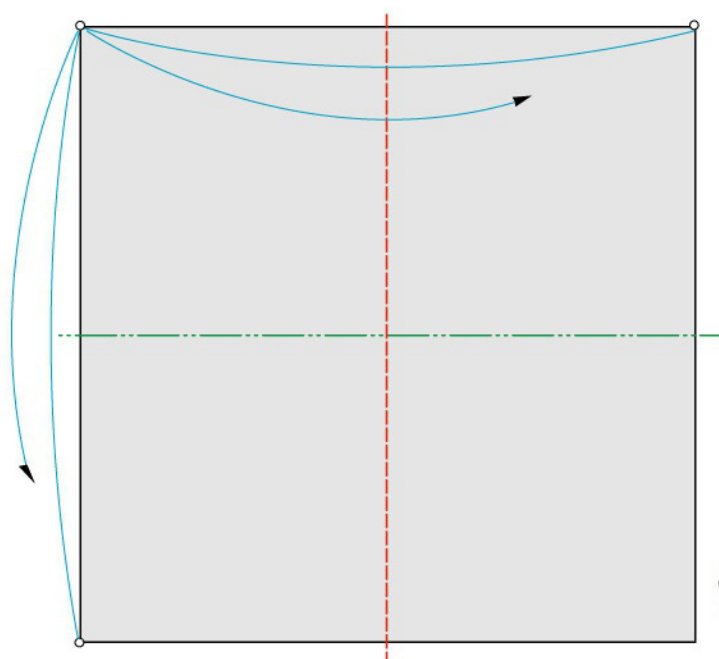

1 piega a valle e 1 a monte

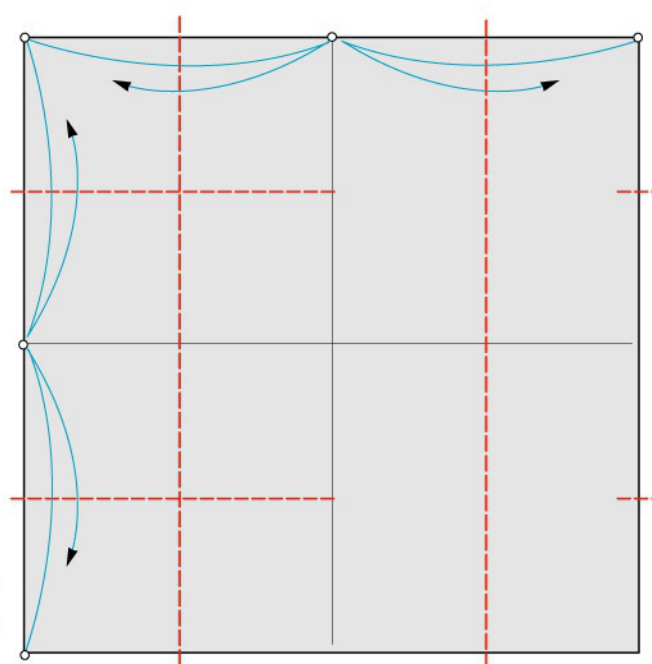

6 pieghe a valle, di cui 2 piccole

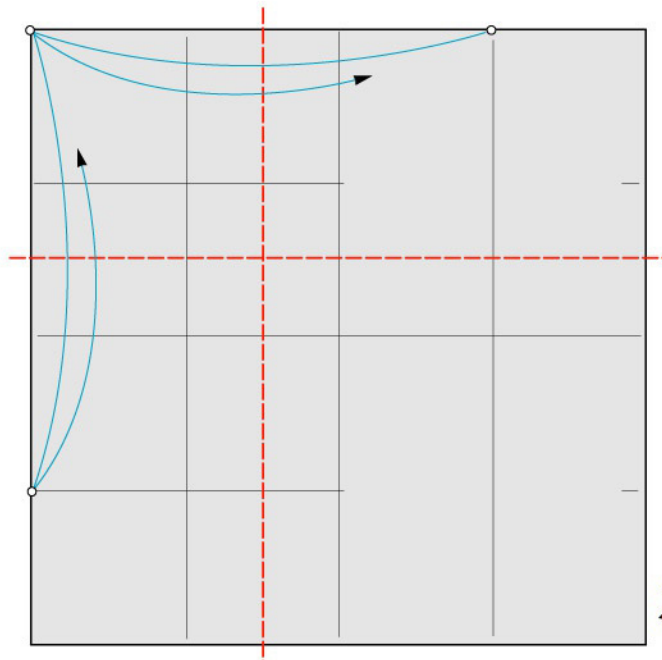

2 pieghe a valle

3

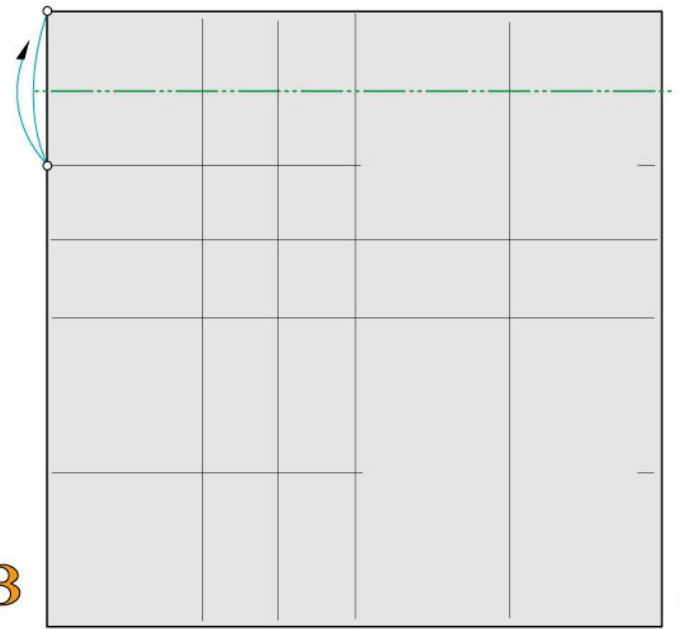

4

1 piega a monte

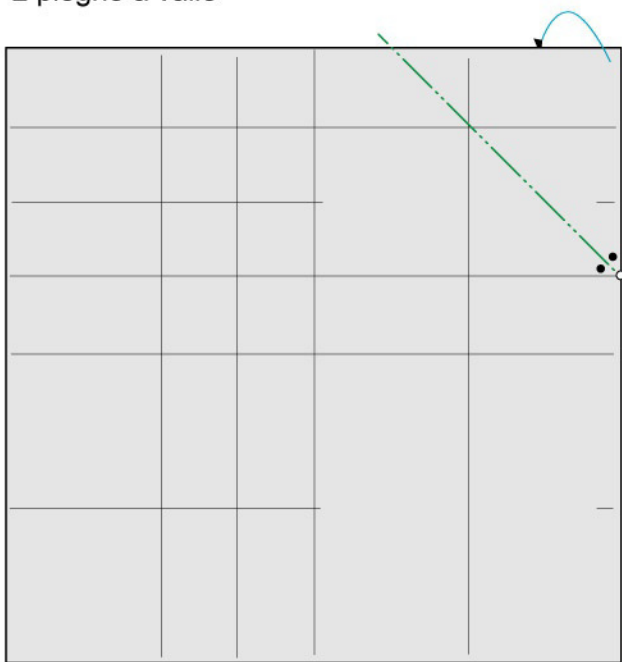

5

1 piega bisettrice a monte

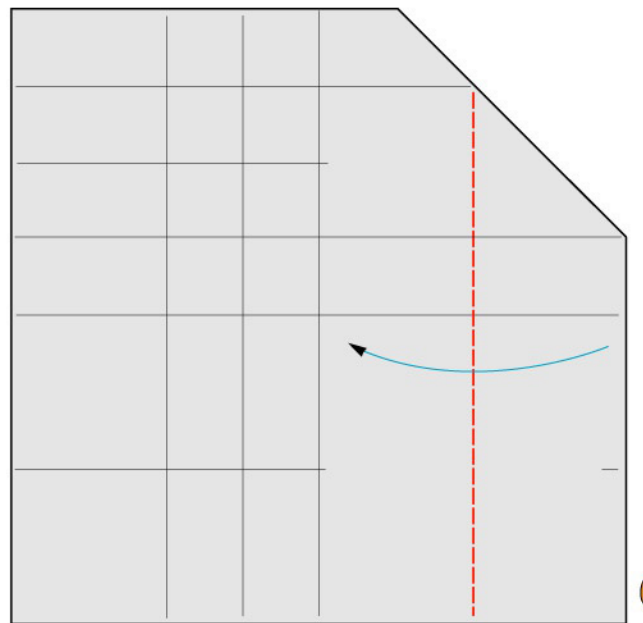

6

Ripiegate a valle

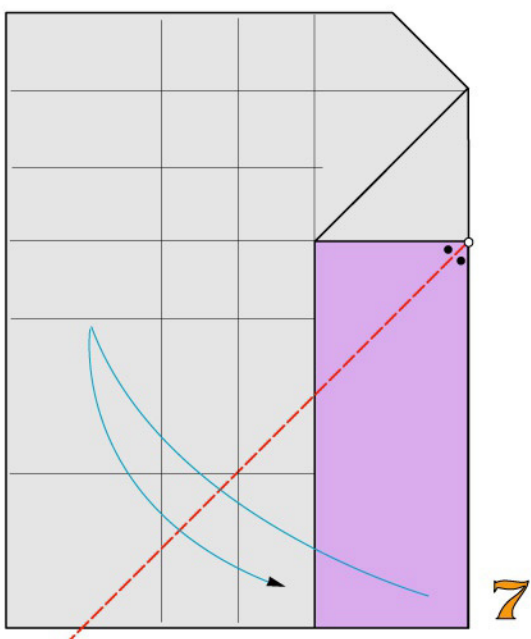

7

1 piega bisettrice a valle

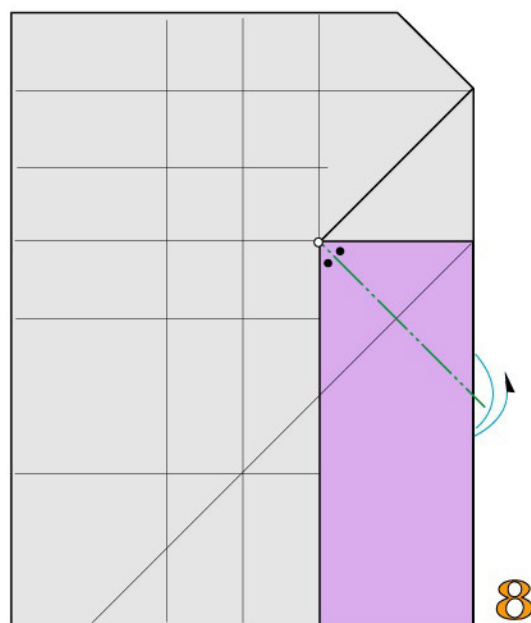

8

1 piega bisettrice a monte

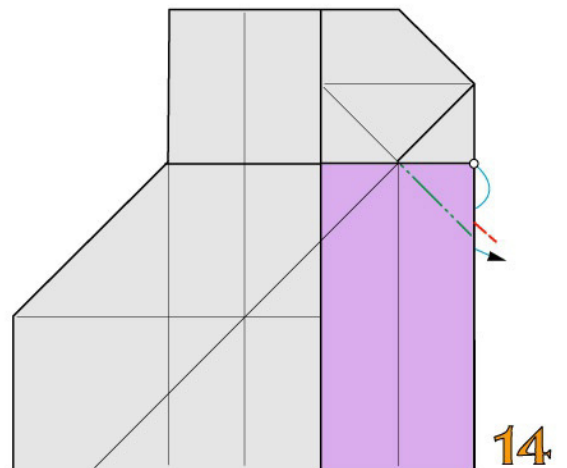
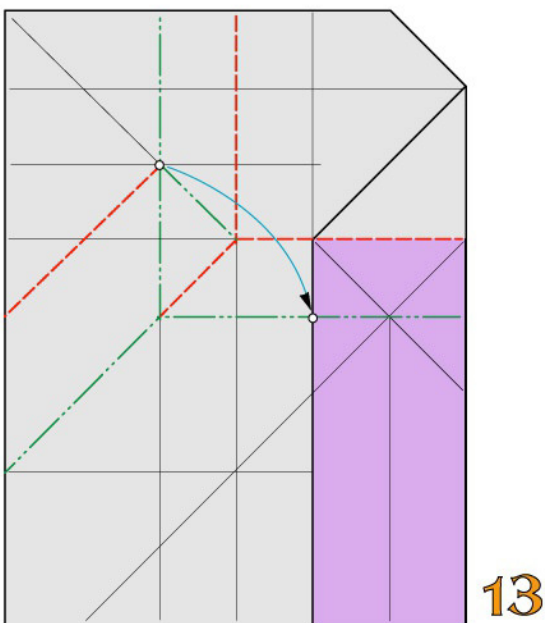
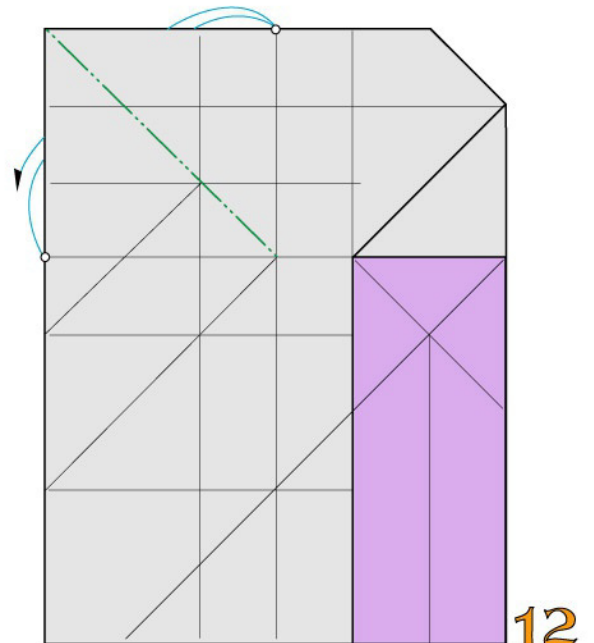
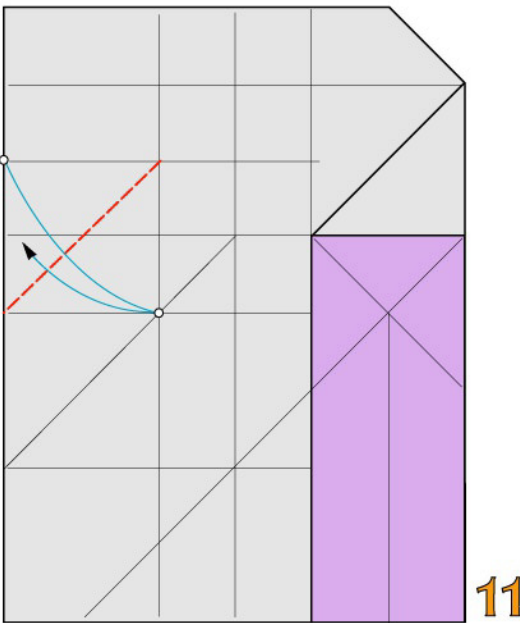
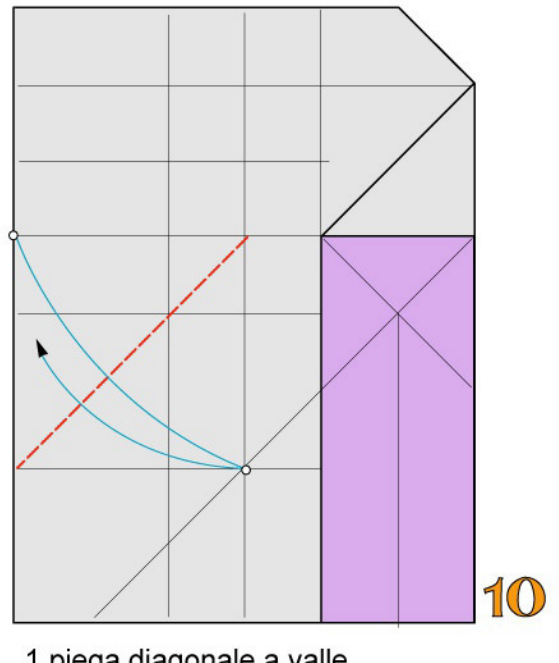
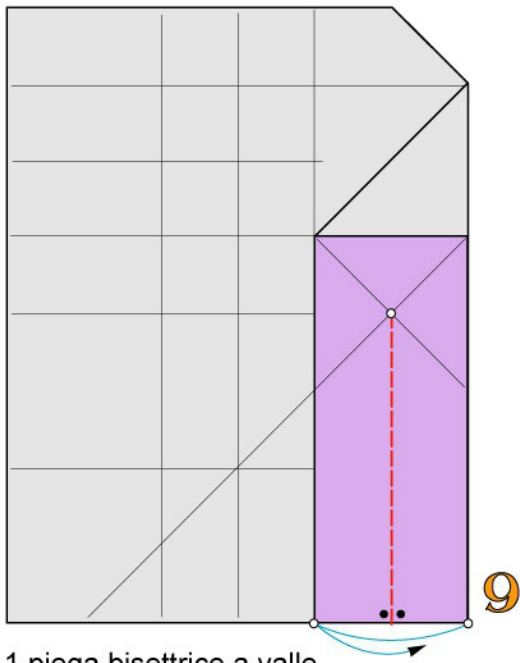

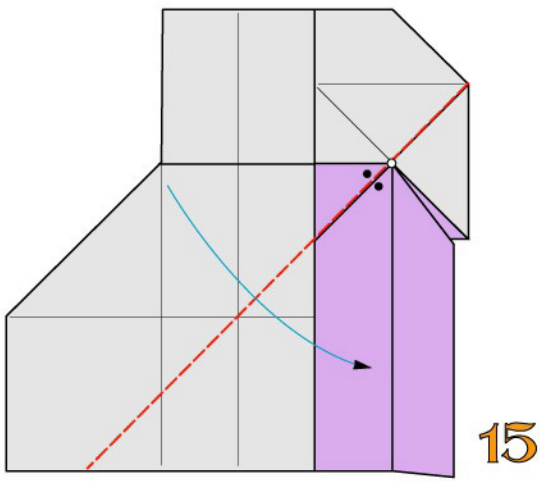

15

1 piega bisettrice a valle

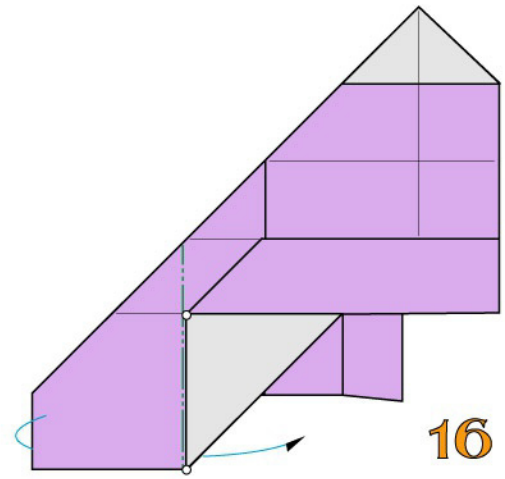

16

1 piega a monte

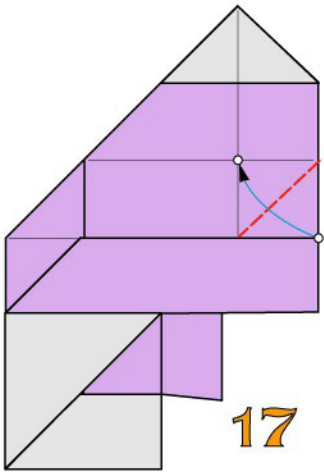

17

1 piega diagonale a valle

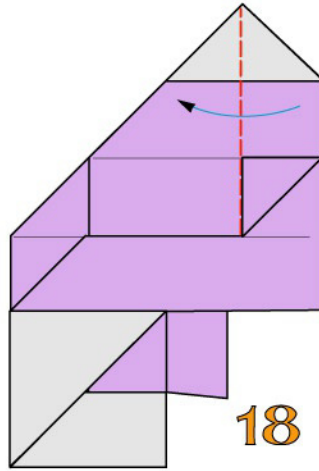

18

Ripiegate a valle

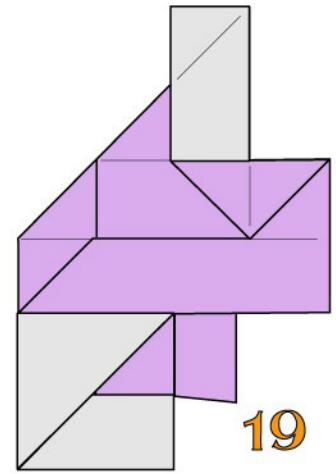

19

Modulo ultimato. Ribaltate

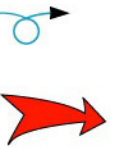

UNIONE DEI MODULI

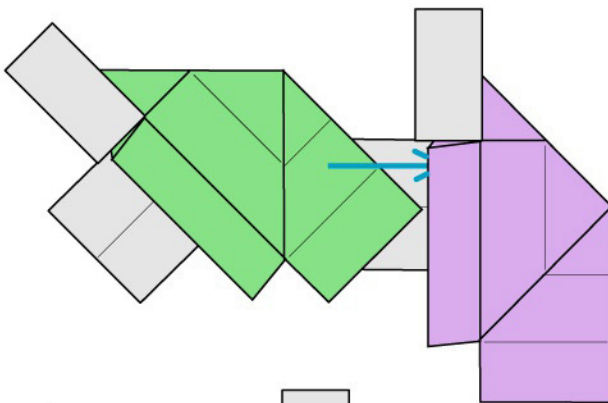

1

Intascate un modulo nell'altro

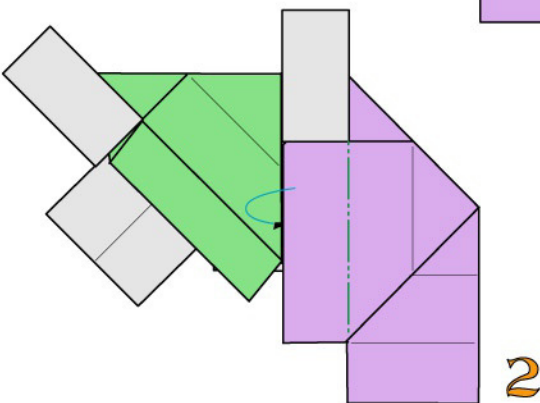

2

Ripiegate a monte

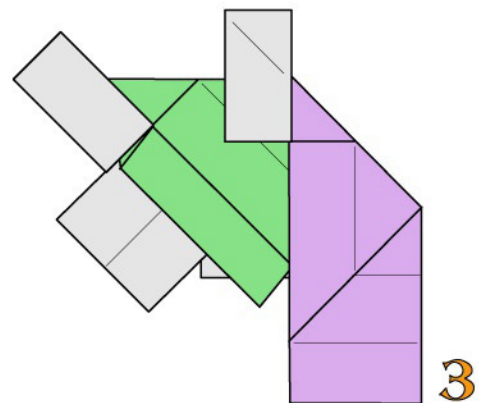

3

Unione completata

GIRANDOLA "I"

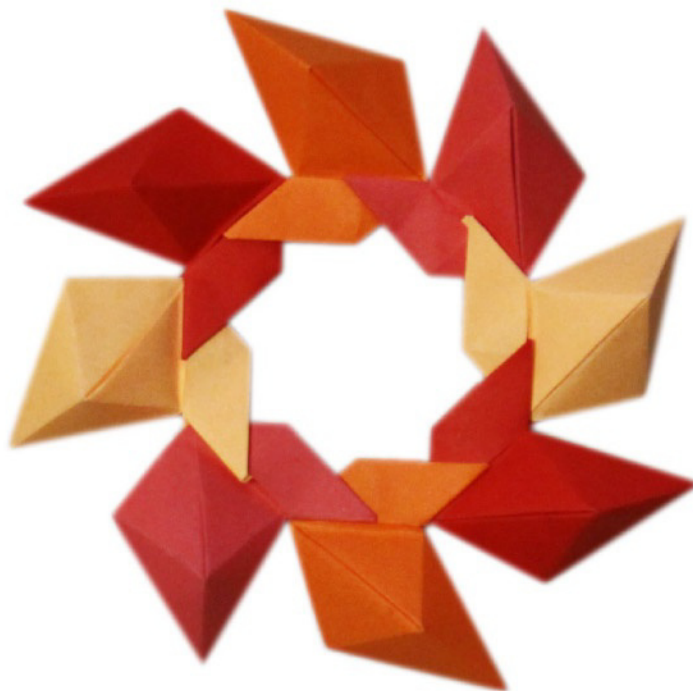

Adoperate 8 mezzi quadrati di carta monocoloro

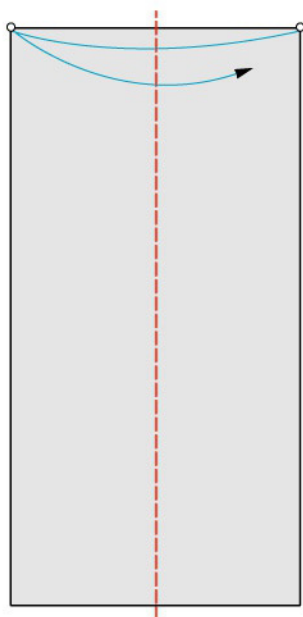

1

1 piega a valle

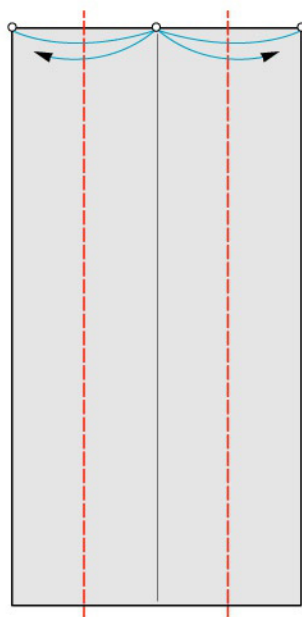

2

2 pieghe a valle

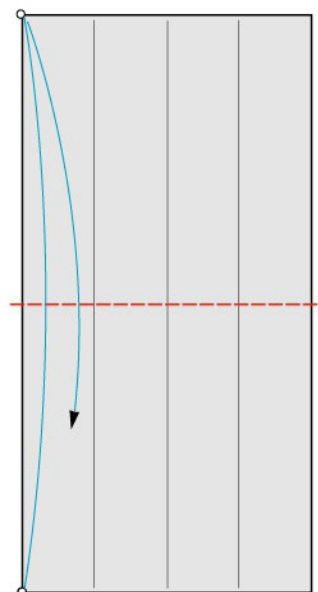

3

1 piega a valle

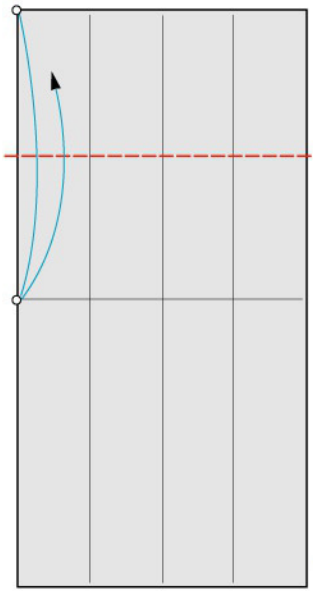

4

1 piega a valle

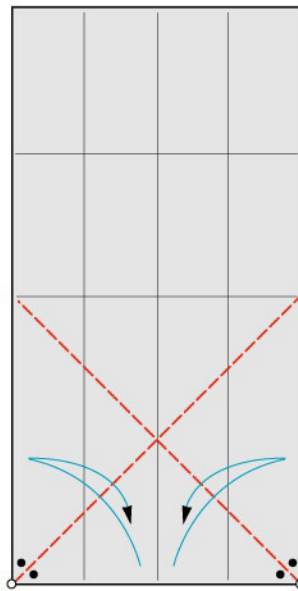

5

2 pieghe bisettrici a valle

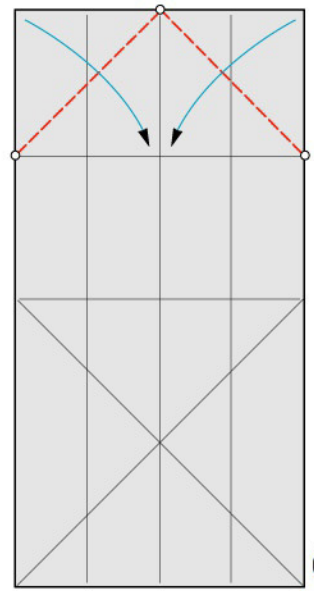

6

2 pieghe diagonali a valle

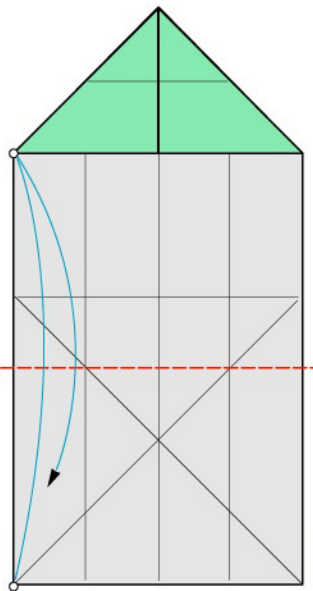

7

1 piega a valle

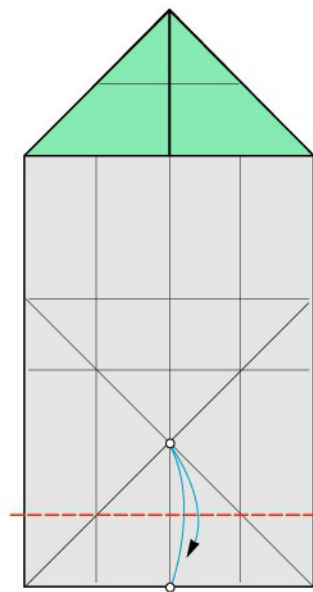

8

1 piega a valle

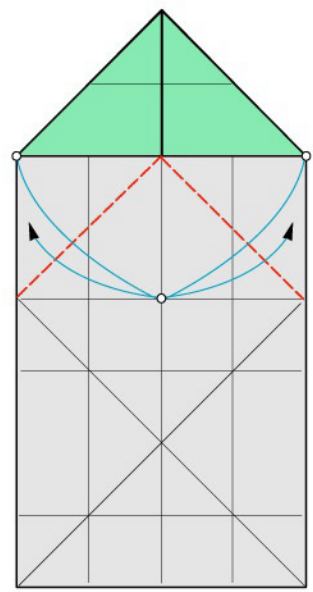

9

2 pieghe diagonali a valle

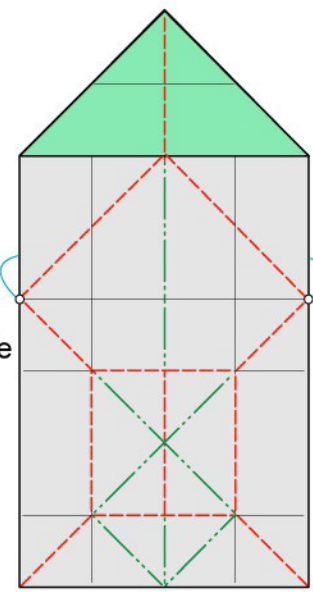

10

Ripiegate a valle e a monte

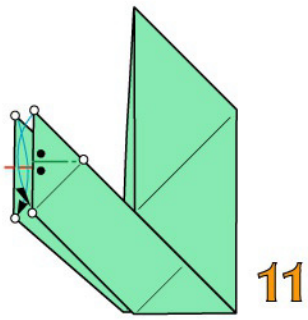

2 pieghe a monte, 1 per lato

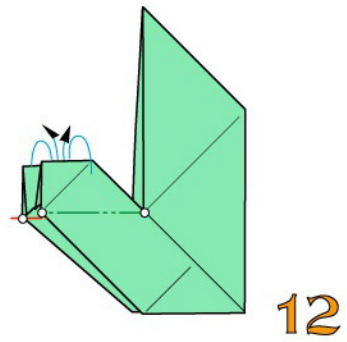

2 pieghe a monte, 1 per lato

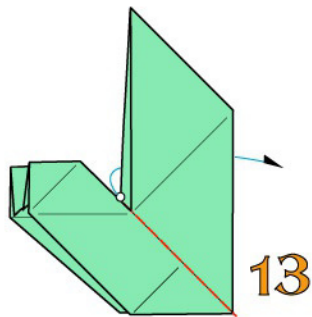

Aprite modellando 3D

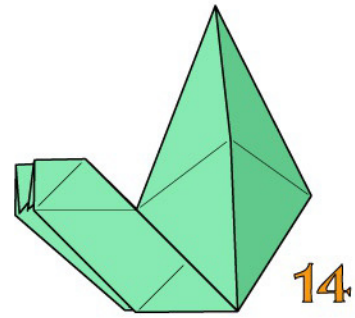

Modulo ultimato

UNIONE DEI MODULI

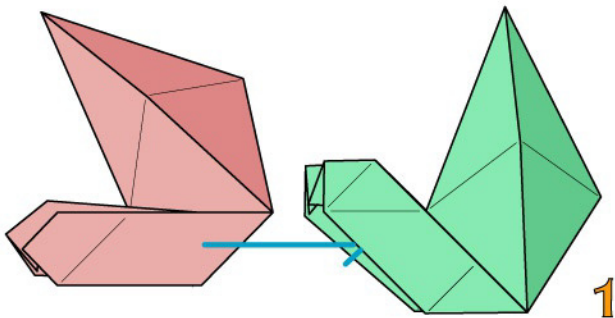

Inserite un modulo nell'altro

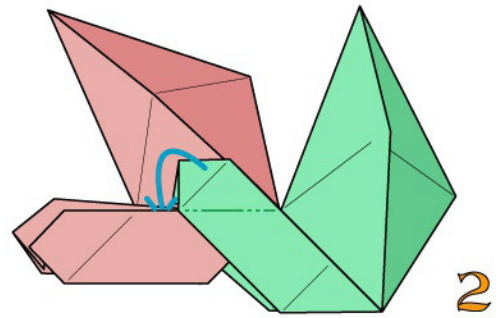

Intascate le 2 appendici, 1 per lato

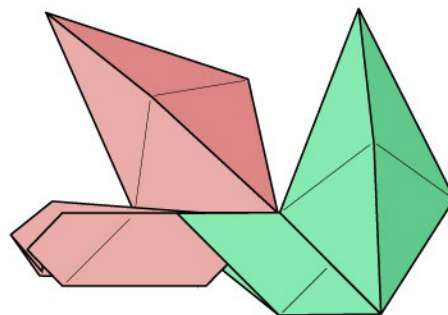

Unione completata

GIRANDOLA "L"

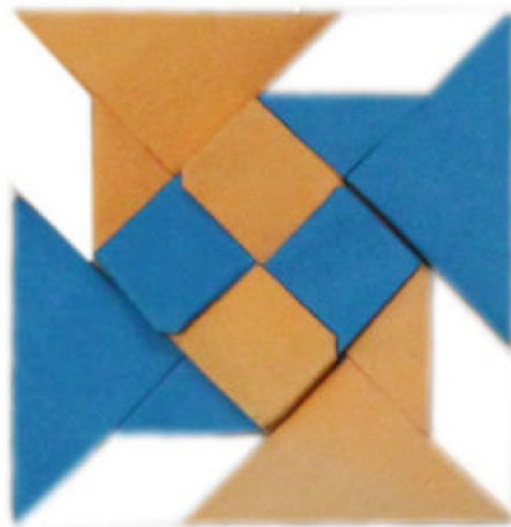

Adoperate 4 mezzi quadrati di carta monocoloro o bicolore

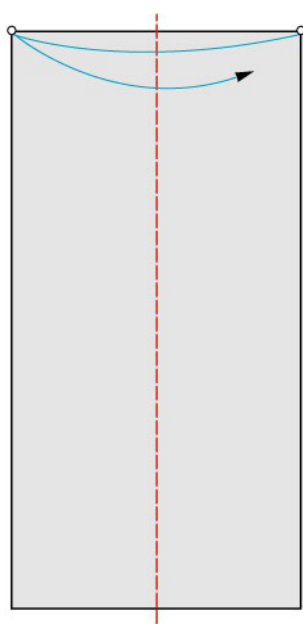

1

1 piega a valle

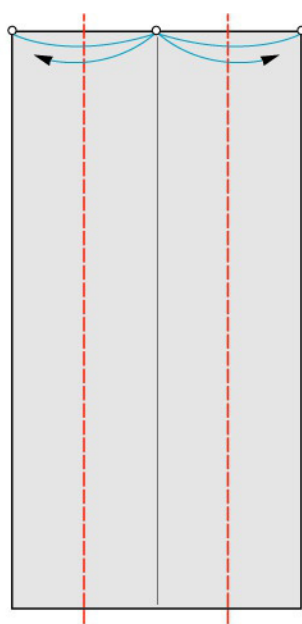

2

2 pieghe a valle

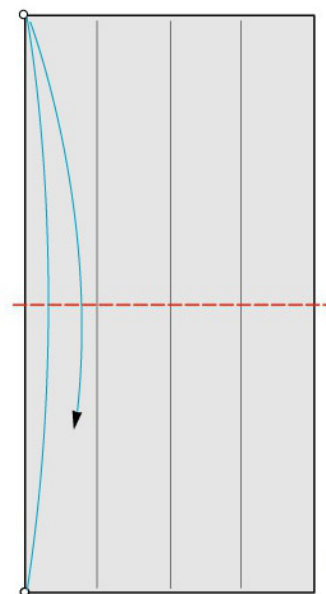

3

1 piega a valle

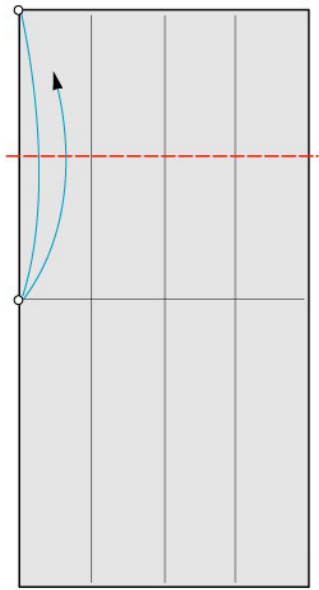

4

1 piega a valle

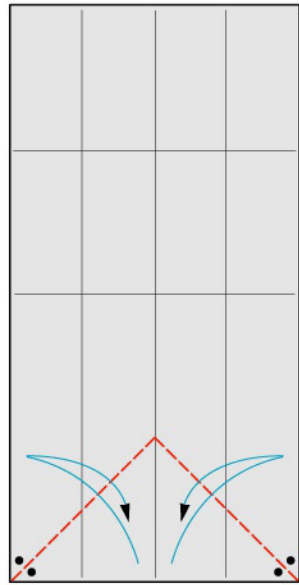

5

2 pieghe bisettici a valle

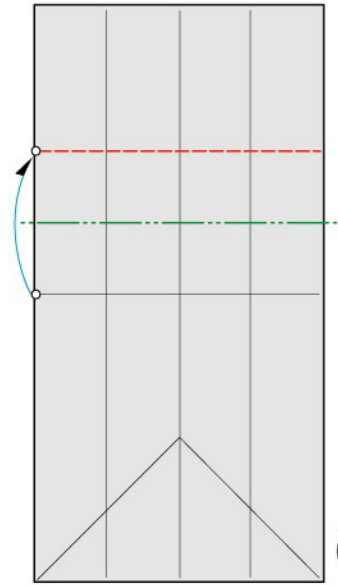

6

1 piega a monte e ripiegate a valle

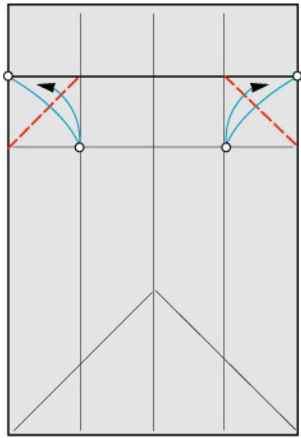

7

2 pieghe diagonali a valle

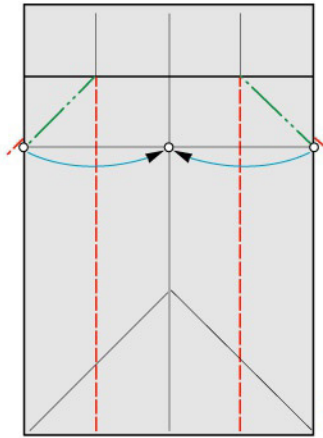

8

Ripiegate a valle e a monte

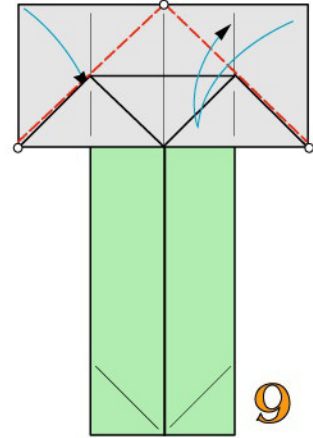

9

2 pieghe diagonali a valle

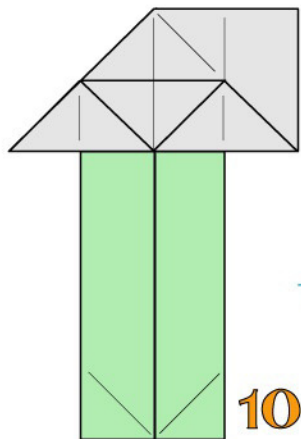

10

Ribaltate

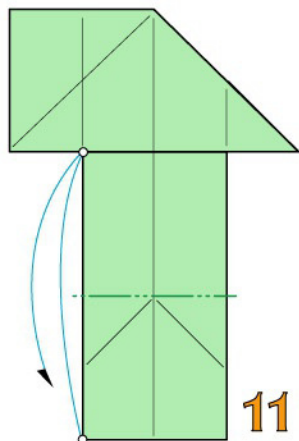

11

1 piega a monte

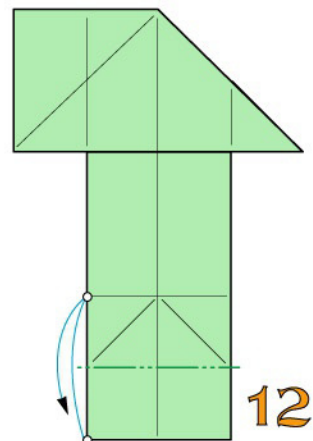

12

1 piega a monte

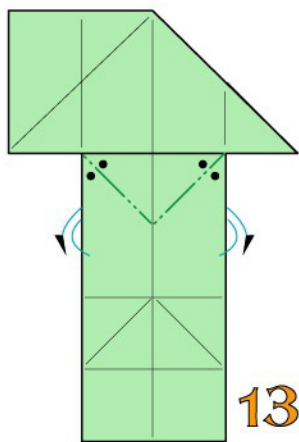

13

2 pieghe bisettrici a monte

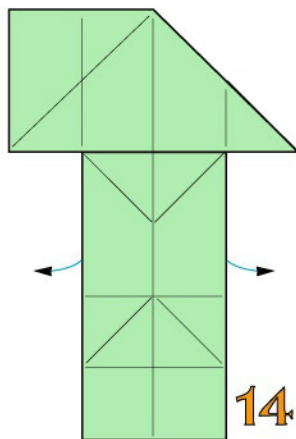

14

Aprite

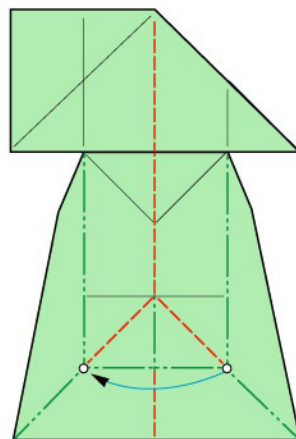

15

Ripiegate a valle e a monte

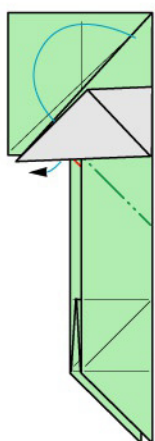

16

1 piega rovescia interna

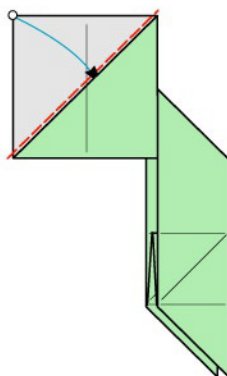

17

Ripiegando a valle intascate

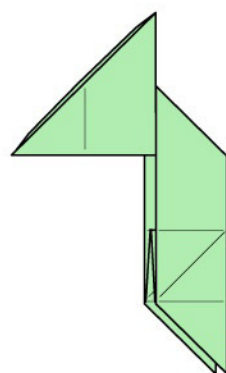

18

Modulo ultimato

UNIONE DEI MODULI

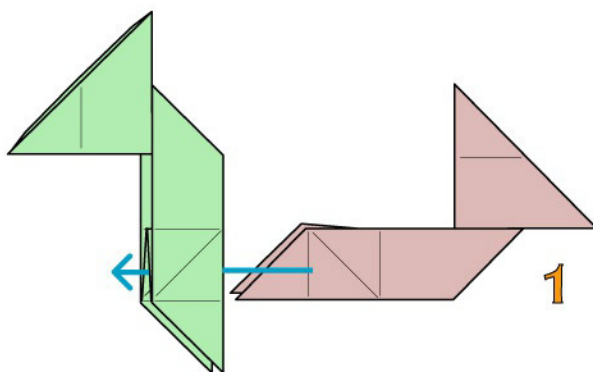

1

Intascate un modulo nell'altro

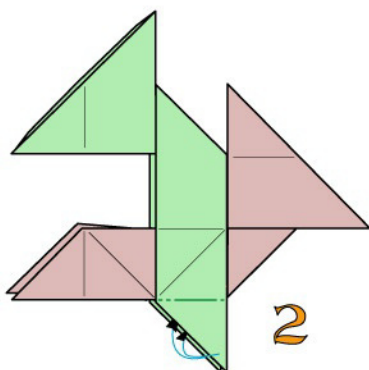

2

Ripiegando intascate le 2 superfici indicate bloccando l'unione

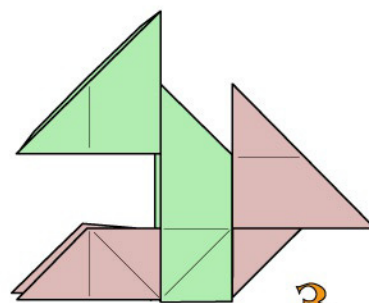

3

Unione completata

NASTRO "A"

Adoperate fogli quadrati monocolori

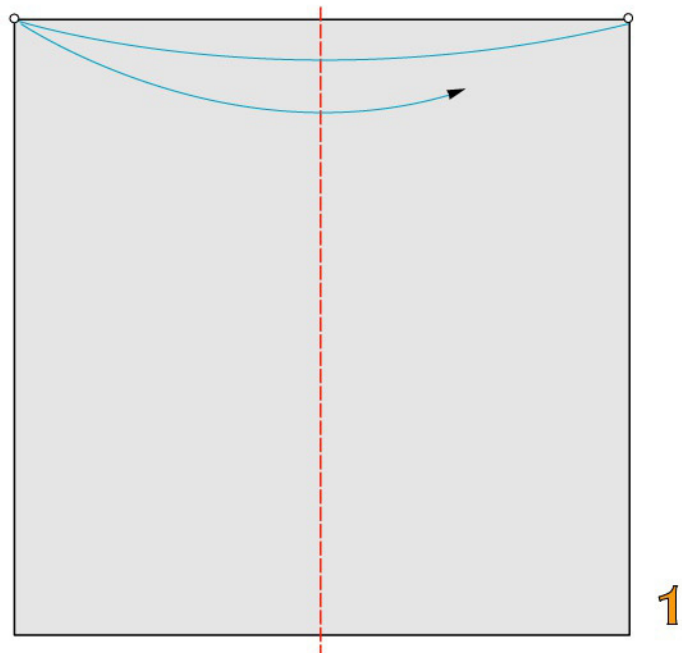

1 piega a valle

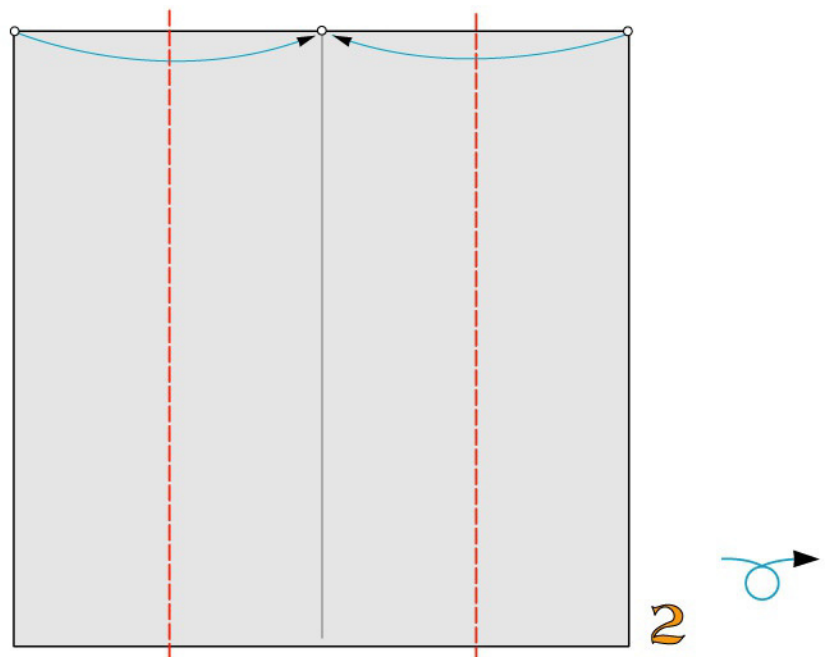

2 pieghe a valle e ribaltate

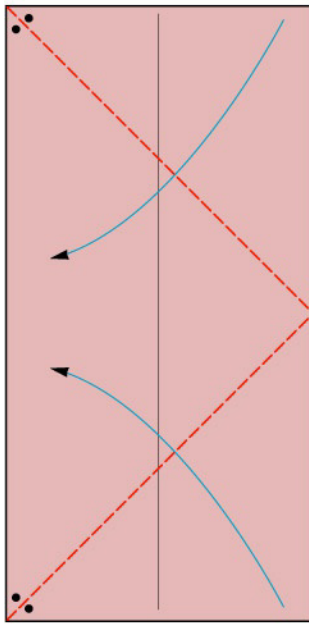

3

2 pieghe bisettrici a valle

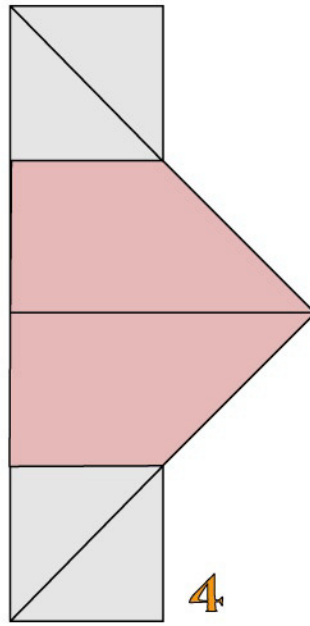

4

Modulo ultimato

COSTRUZIONE MODULO DI TESTA

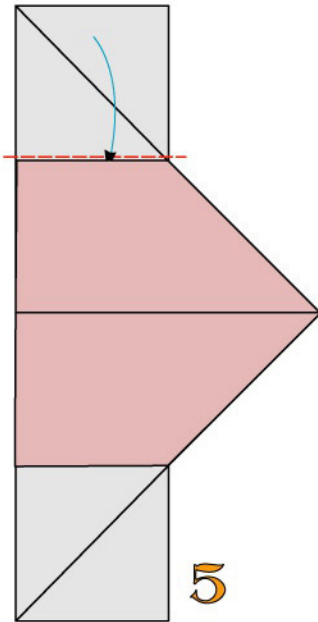

5

1 piega a valle

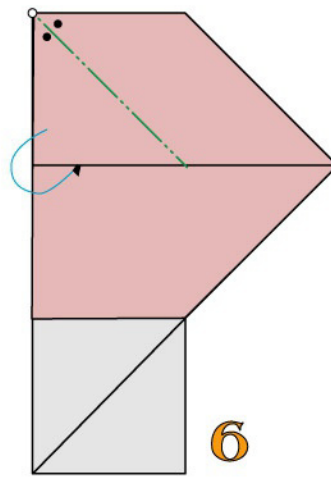

6

1 piega bisettrice a monte

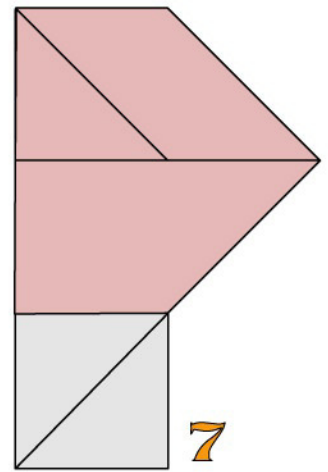

7

Modulo di testa ultimato



UNIONE DEI MODULI

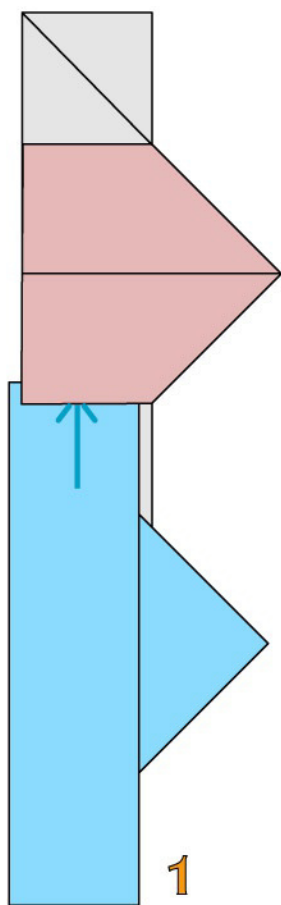

Inserite vicendevolmente
un modulo nell'altro

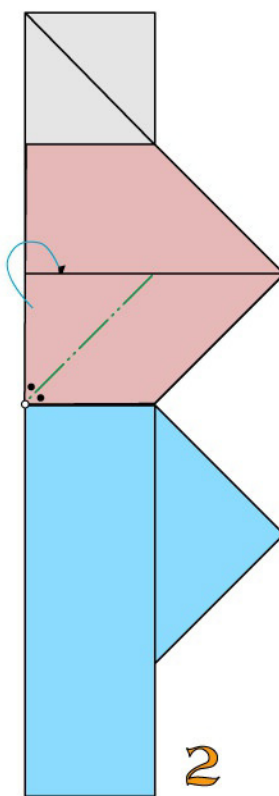

1 piega bisettrice a monte

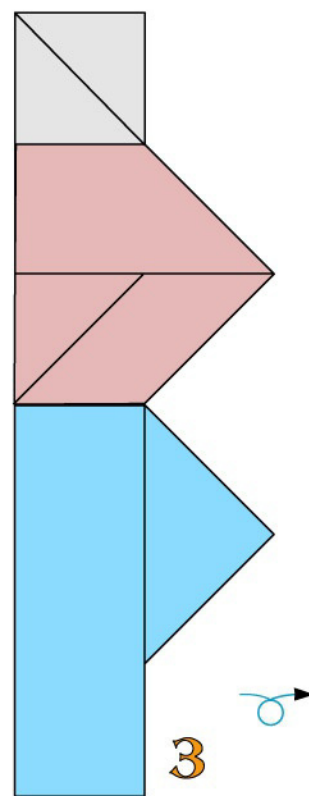

Ribaltate

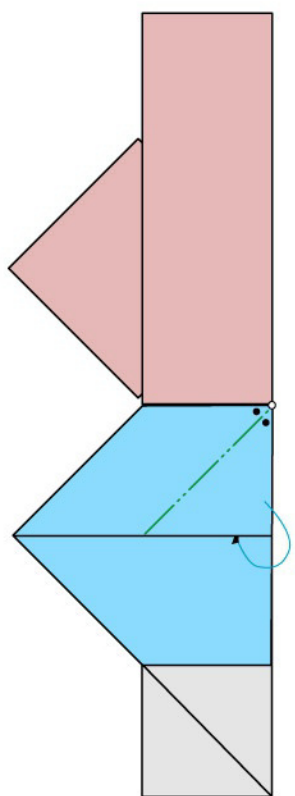

1 piega bisettrice a monte

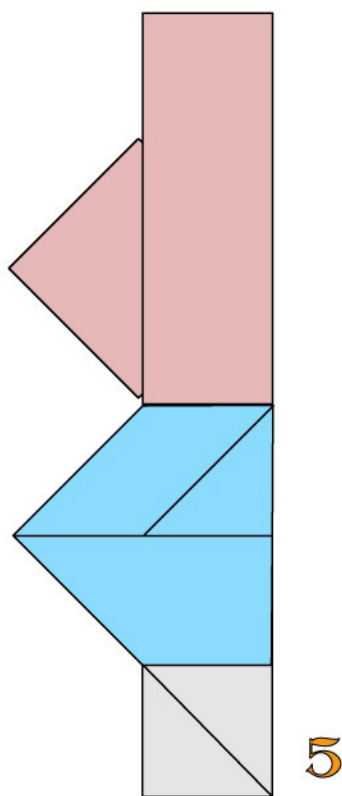

Unione completata

NASTRO "B"

Adoperate fogli quadrati monocolori

Il modulo "B" necessario per costruire questo nastro è formato dall'unione di 2 moduli-base

Use one-color square sheets.

The "B" module needed to build this tape is formed by joining 2 basic modules

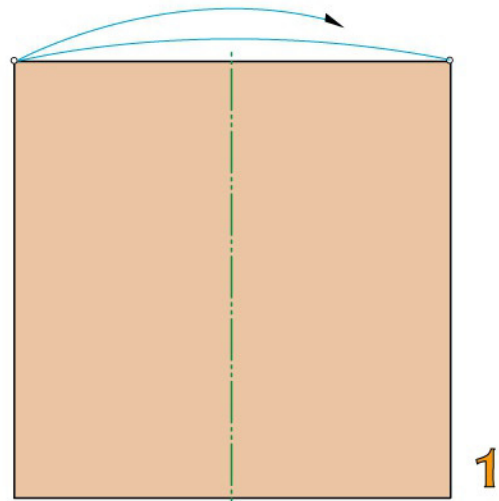
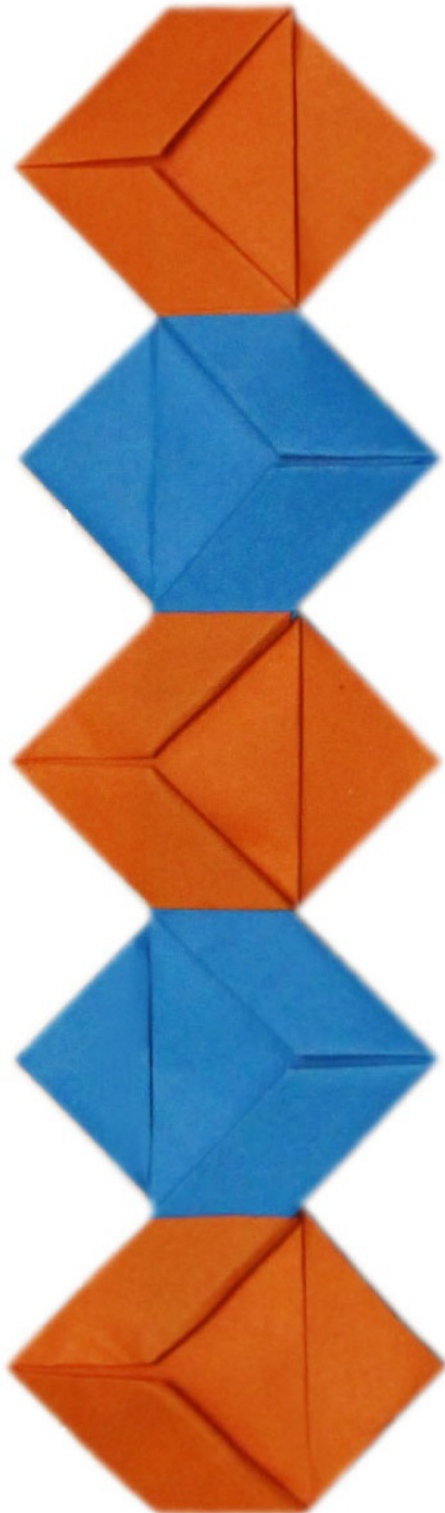

1 piega a monte

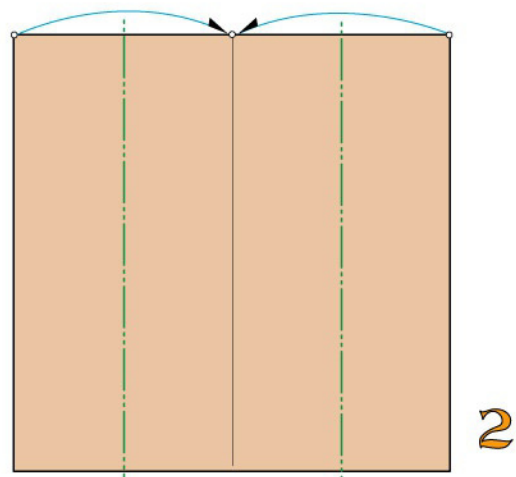

2 pieghe a monte

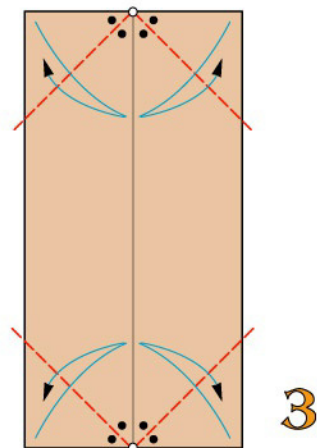

4 pieghe bisettrici a valle

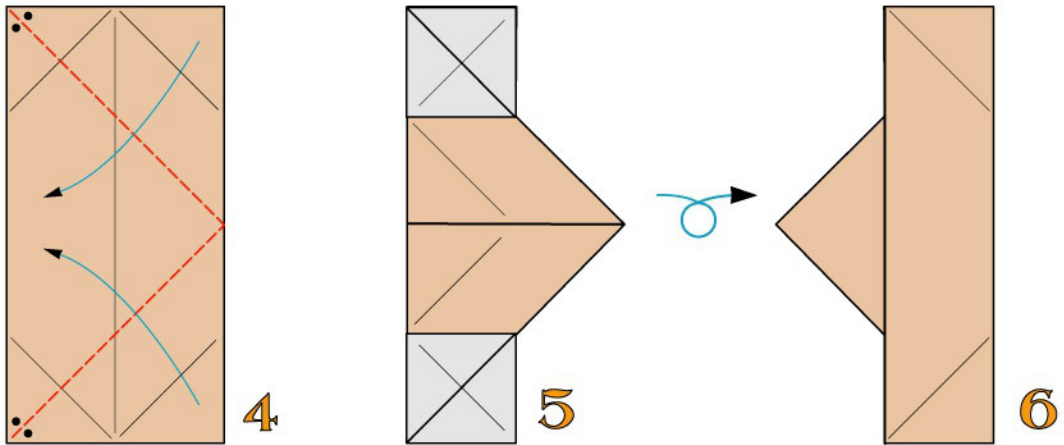

2 pieghe bisettrici a valle

Modulo-base ultimato

Modulo-base ultimato ribaltato

COSTRUZIONE DEL MODULO "B"

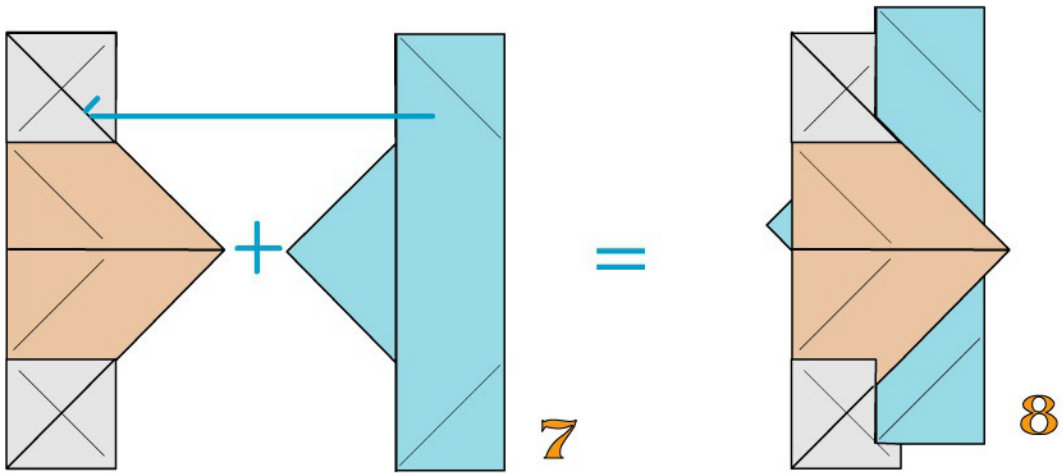

Inserite un modulo-base ribaltato in un altro modulo-base

Insert a reversed base-module into another base-module

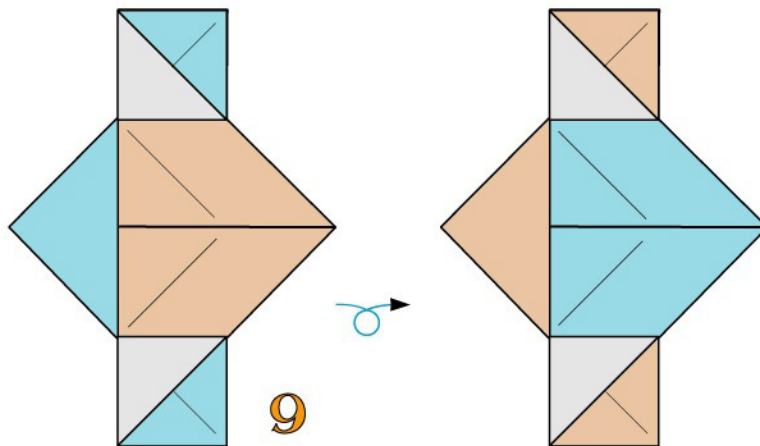

Modulo "B" ultimato

Modulo "B" ultimato ribaltato

UNIONE DEI MODULI "B"

Inserite vicendevolmente un modulo "B" nell'altro

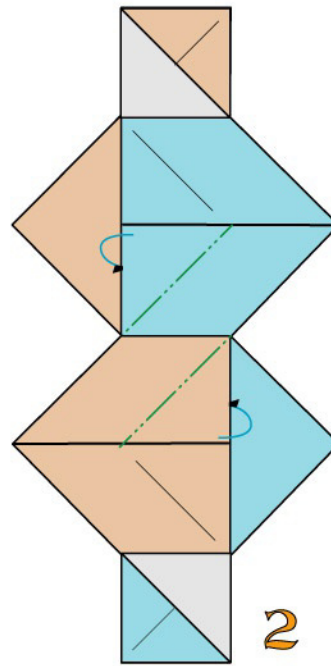
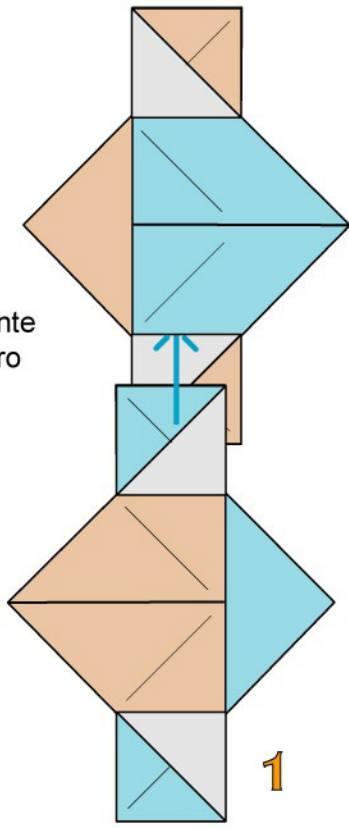

2 pieghe a monte

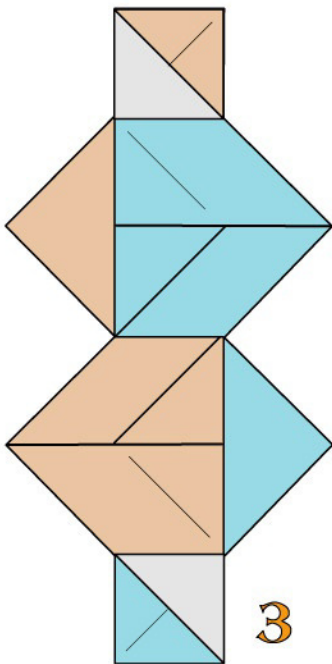

Ribaltate

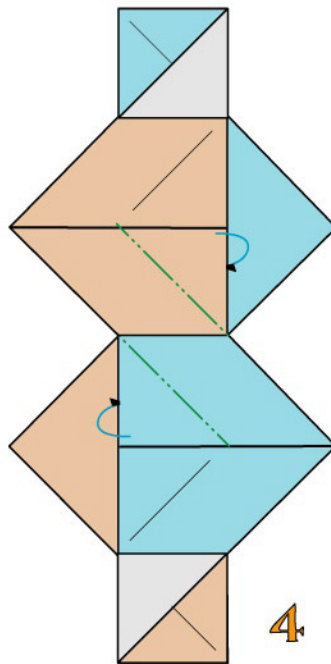

2 pieghe a monte

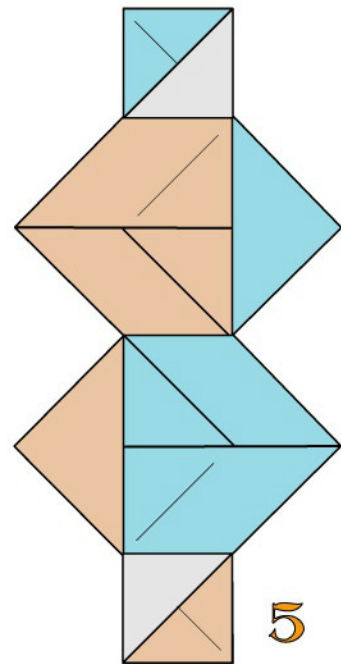

Unione di 2 moduli "B" completata

NASTRO "C"

Adoperate fogli quadrati monocolori

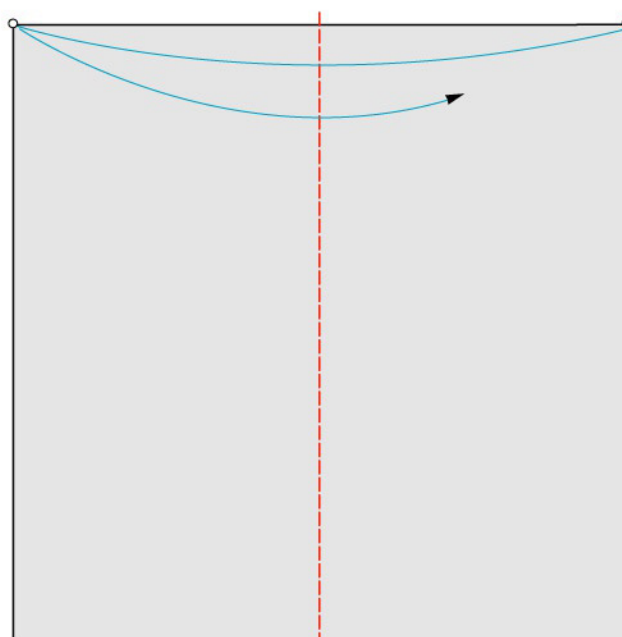

1

1 piega a valle

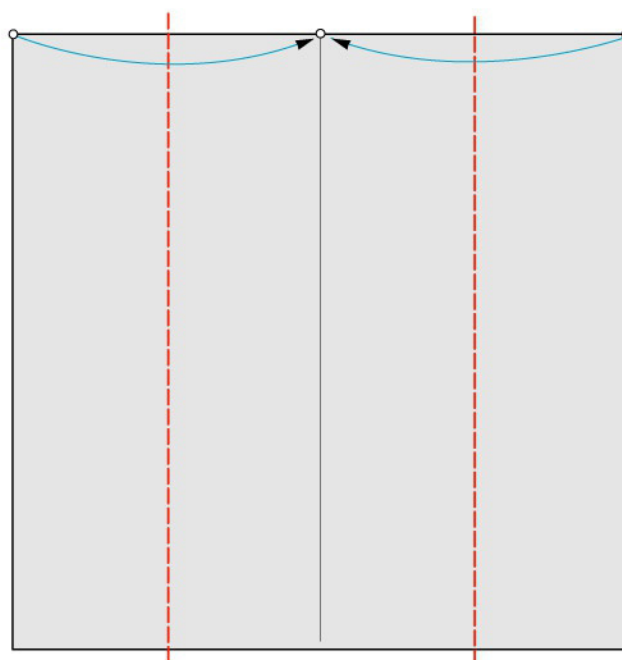

2



2 pieghe a valle e ribaltate

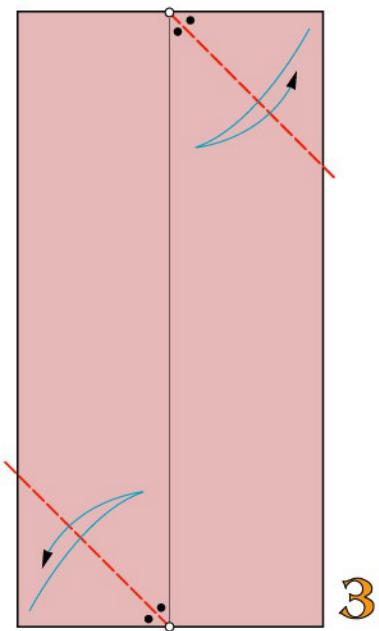

2 pieghe bisettrici a valle

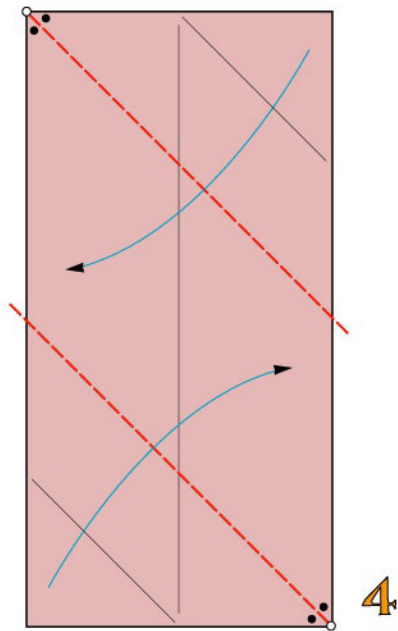

2 pieghe bisettrici a valle

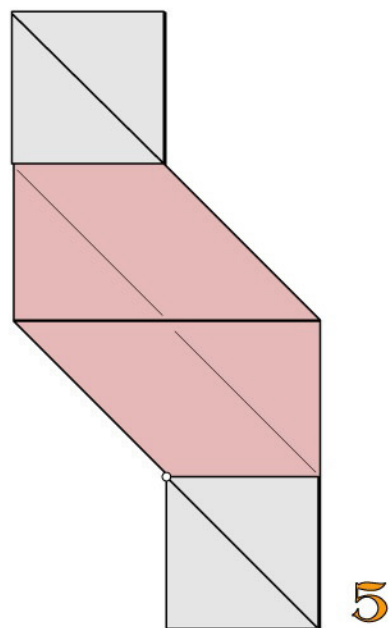

Modulo ultimato

COSTRUZIONE MODULO DI TESTA

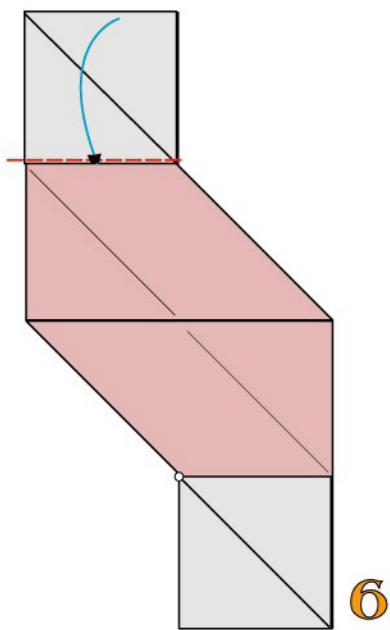

1 piega a valle

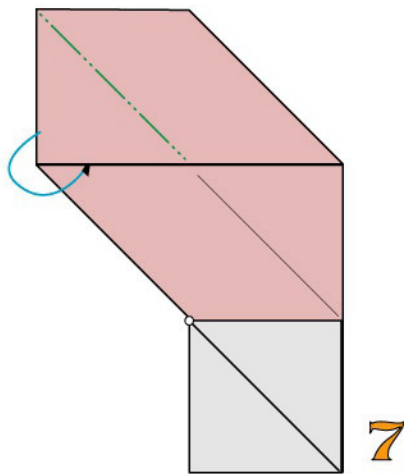

1 piega bisettrice a monte

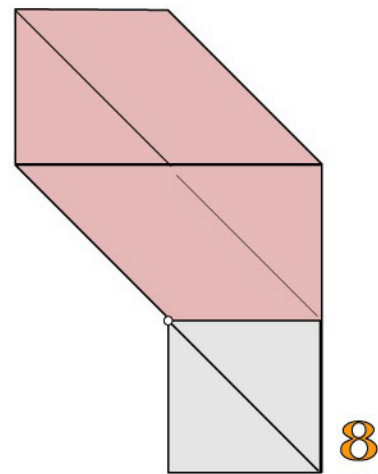

Modulo di testa ultimato



UNIONE DEI MODULI

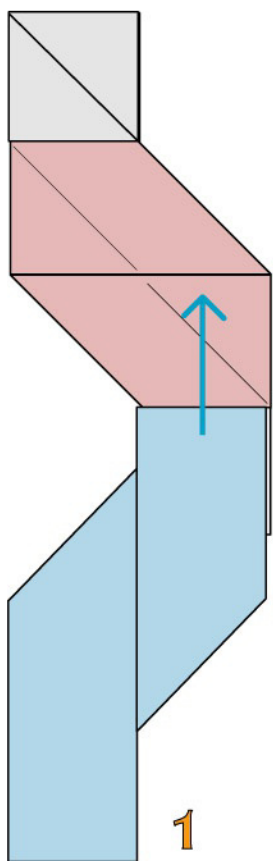

Inserite vicendevolmente un modulo nell'altro

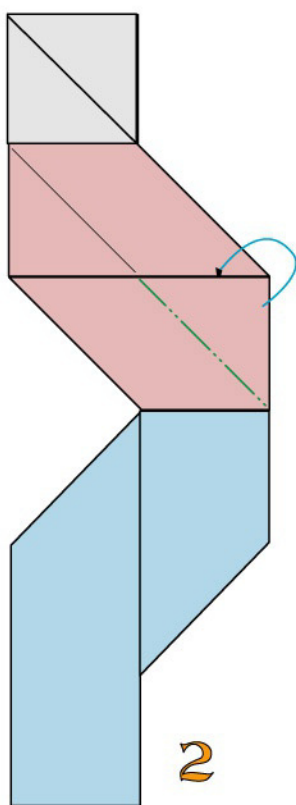

1 piega bisettrice a monte

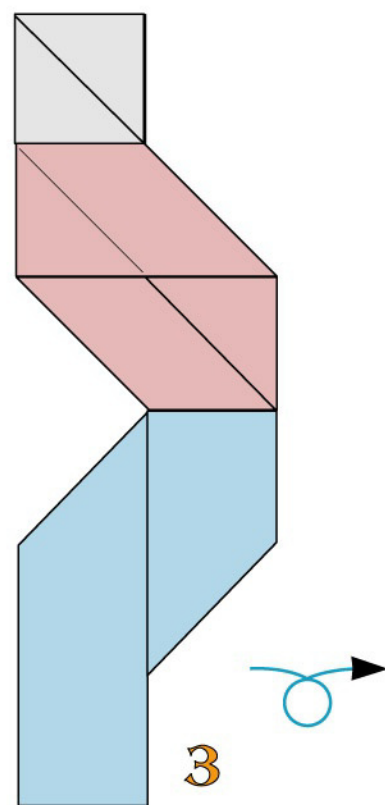

Capovolgete

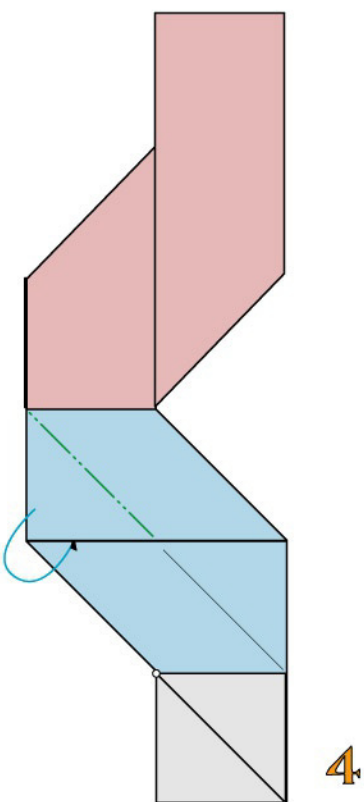

1 piega bisettrice a monte

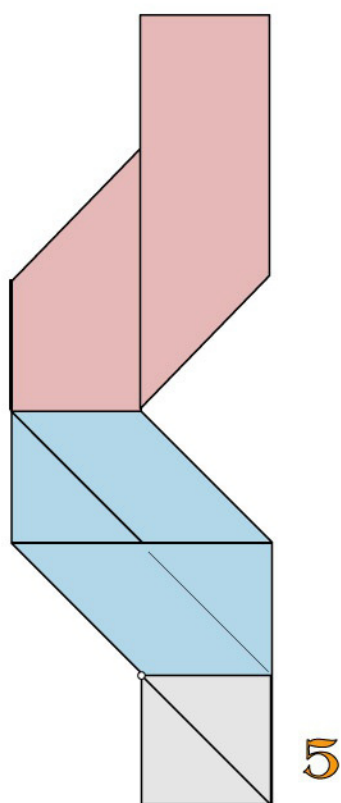

Unione completata

NASTRO "D"

Adoperate fogli quadrati monocolori.

Per la realizzazione di un bracciale adoperate 8 fogli quadrati di 4 cm di lato.

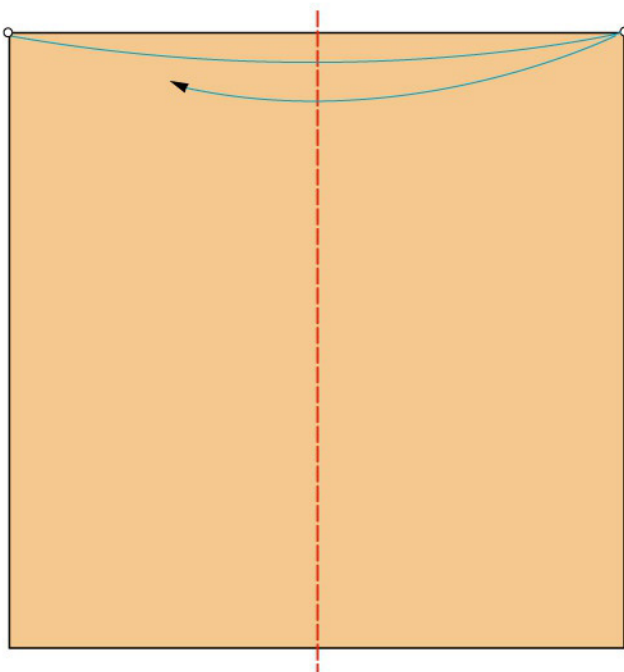

1 piega a valle

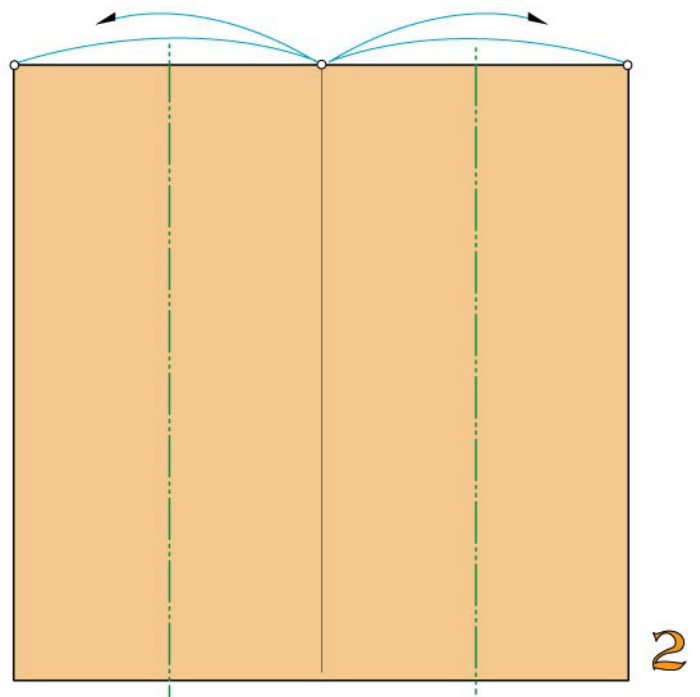

2 pieghe a monte

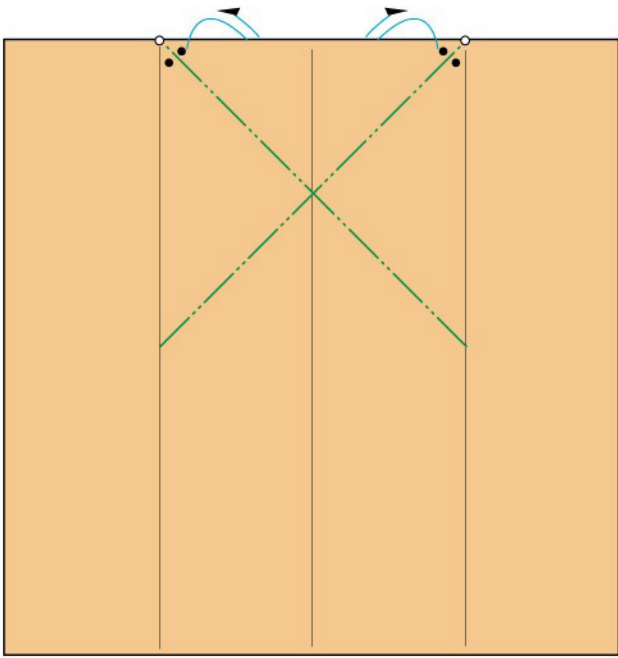

2 pieghe bisettrici a monte

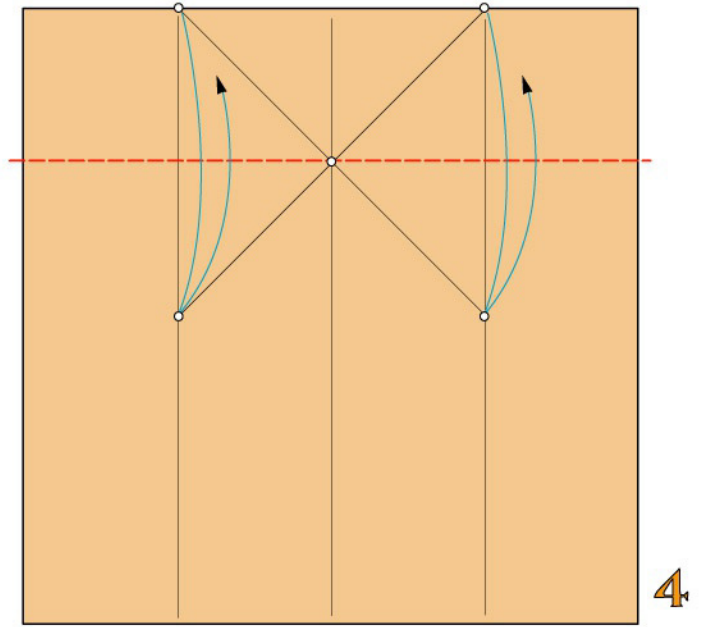

1 piega a valle

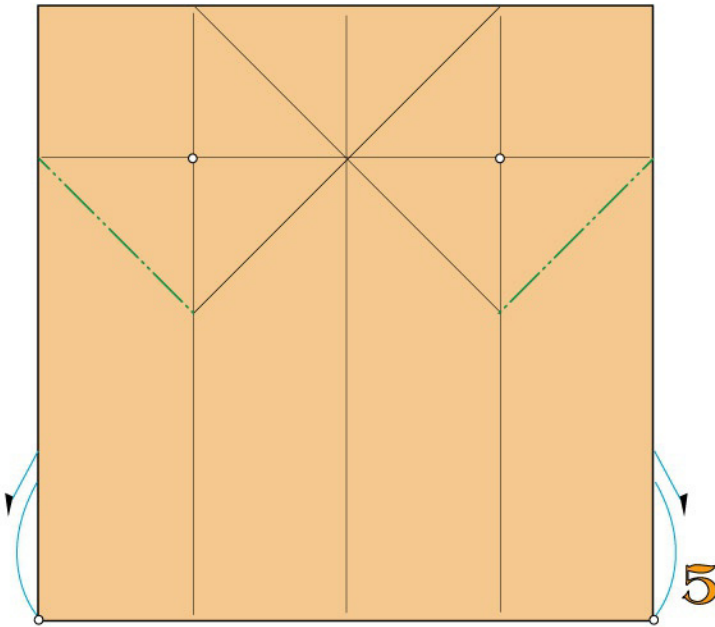

2 pieghe a monte

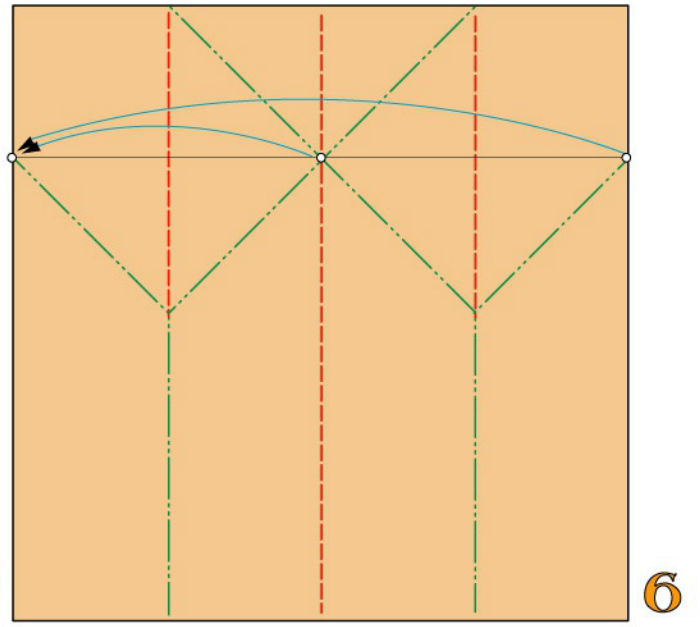

Ripiegate a valle a monte

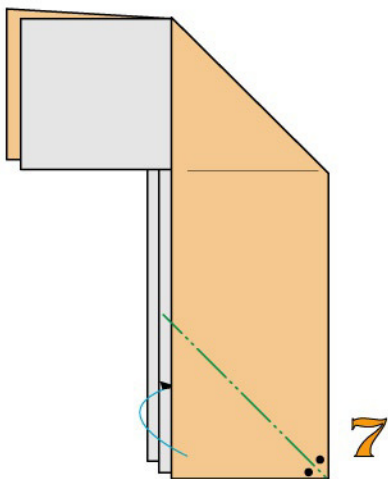

1 piega a monte

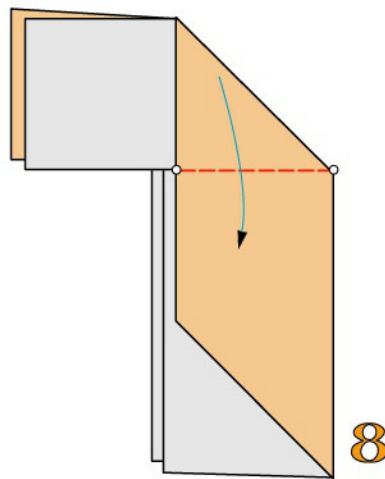

1 piega a valle

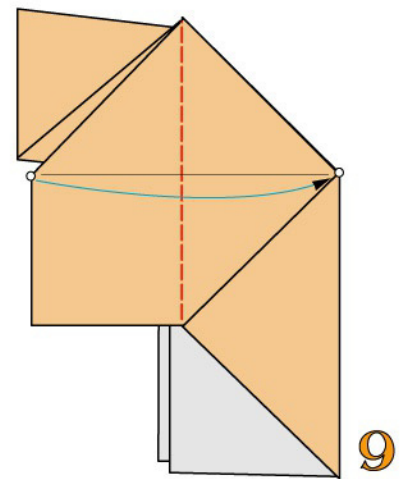

1 piega a valle

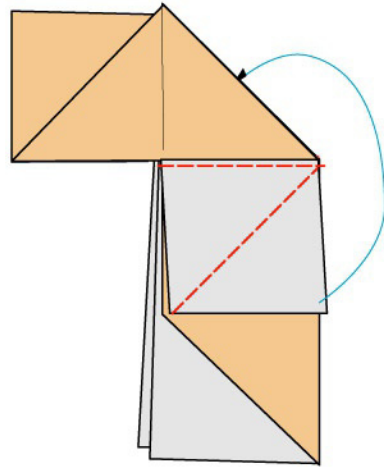

2 pieghe a valle e inseritenell'ultima tasca
2 folds downstream and inserted into the last pocket

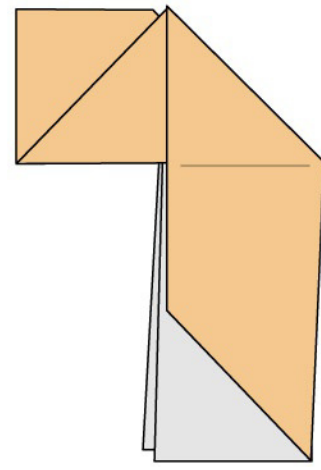

Modulo ultimato



UNIONE DEI MODULI

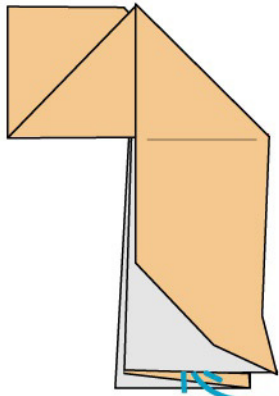

Intascate l'estremità di un modulo nell'altro

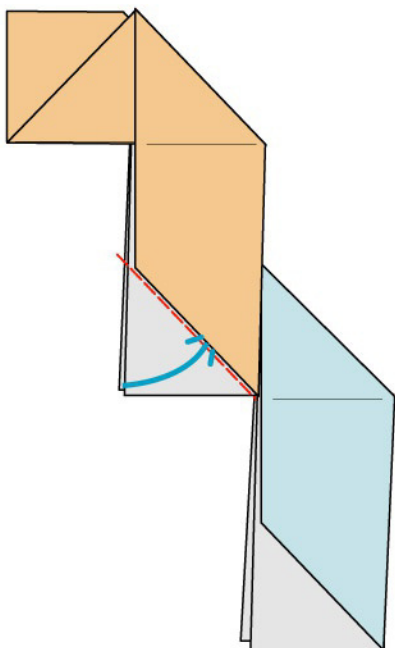
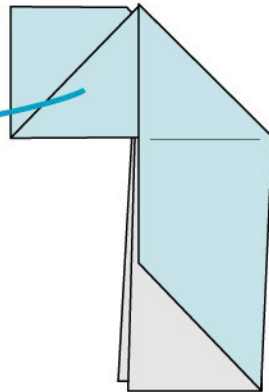

Mediante 1 piega a valle intascate e bloccate l'unione

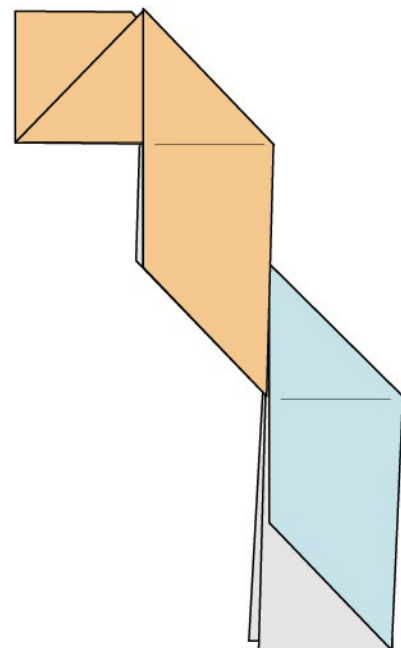

Unione completata

NASTRO "€"

Adoperate fogli quadrati bicolori

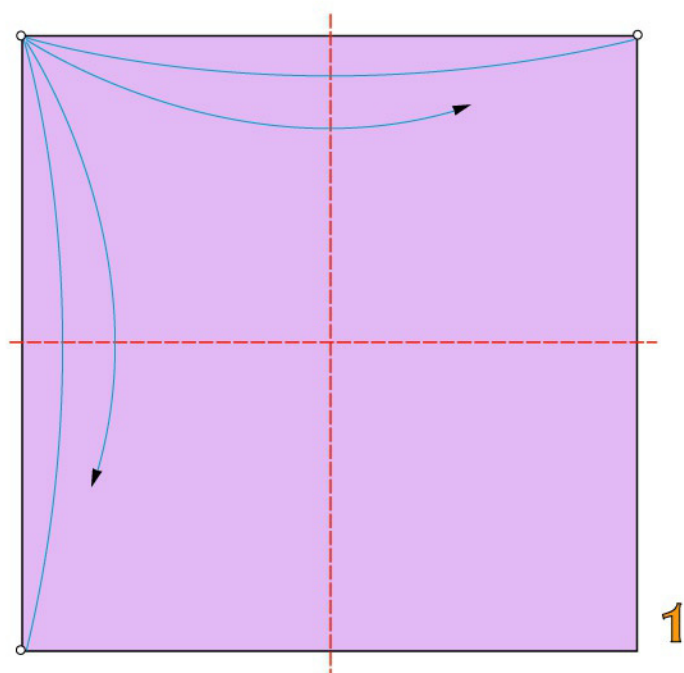

2 pieghe a valle

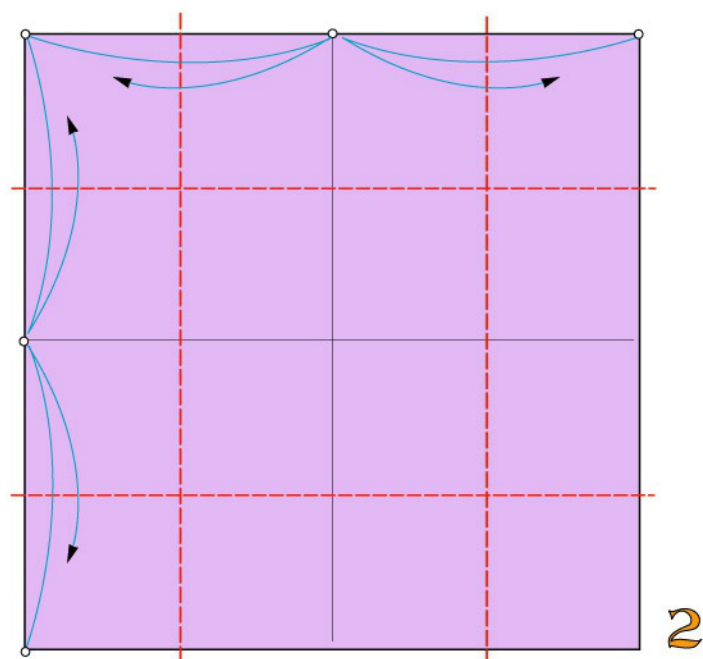

4 pieghe a valle

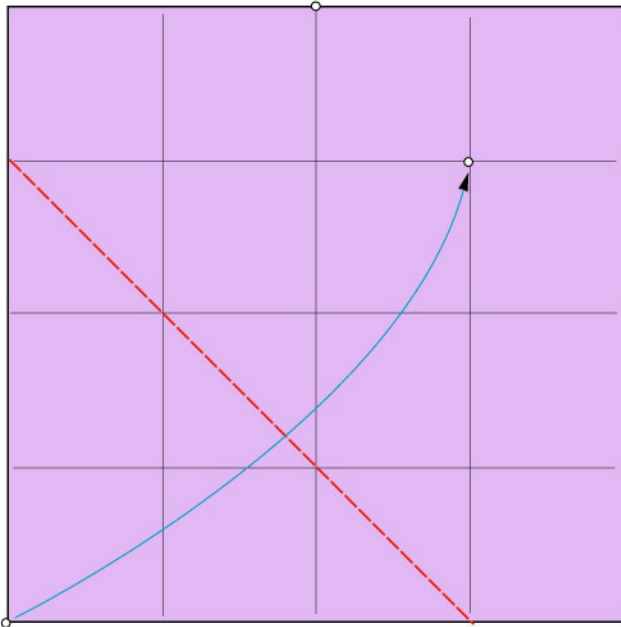

1 piega diagonale a valle

3

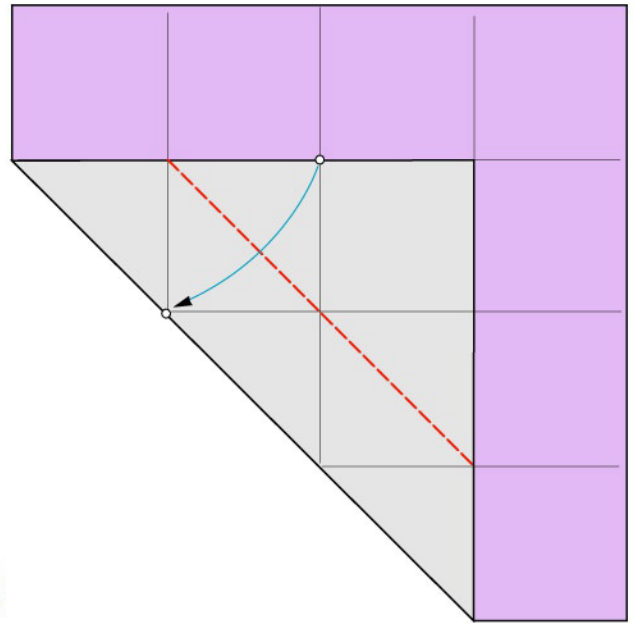

1 piega diagonale a valle

4

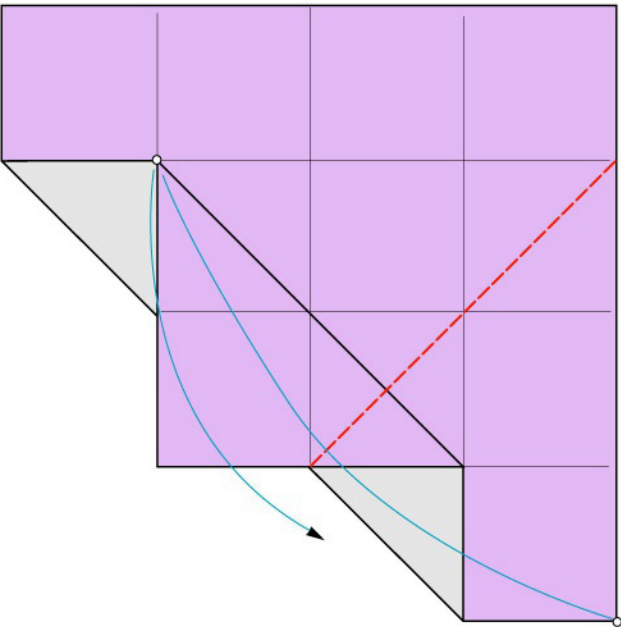

1 piega diagonale a valle

5

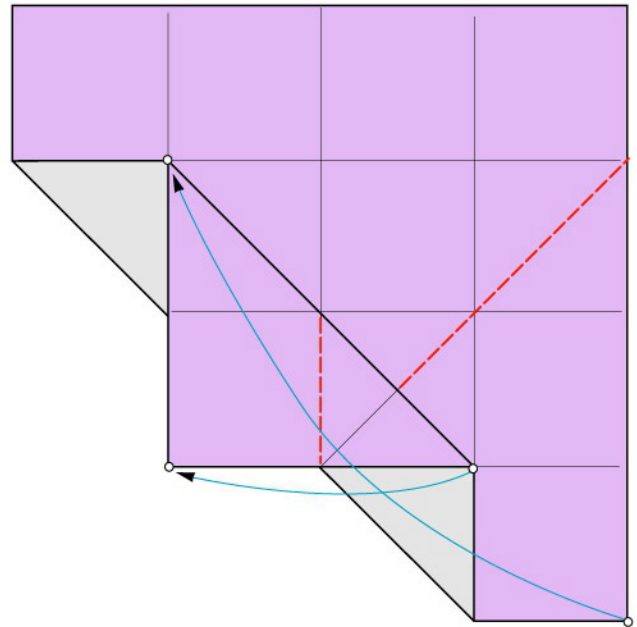

Ripiegate a valle e a monte

6

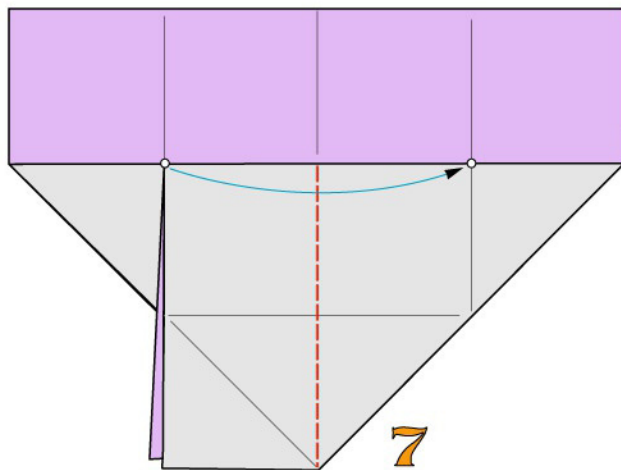

1 piega a valle

7

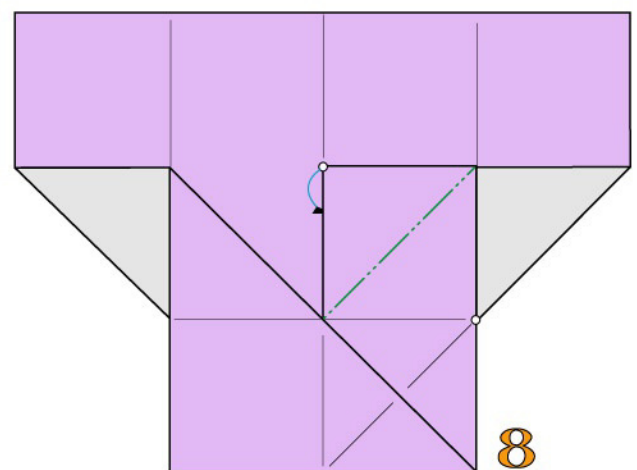

1 piega a monte

8

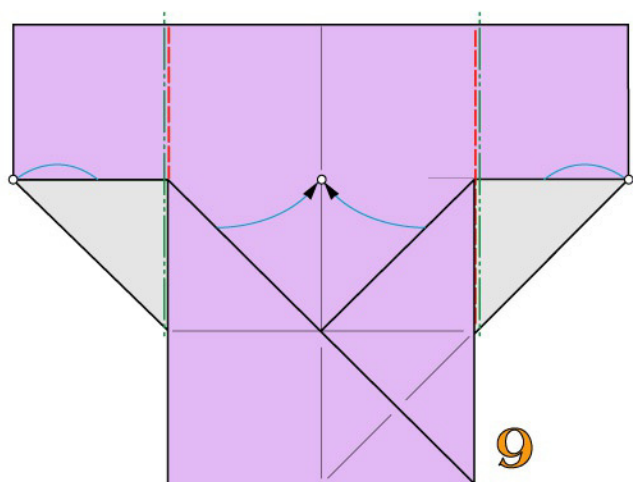

9

2 pieghe rovesce interne

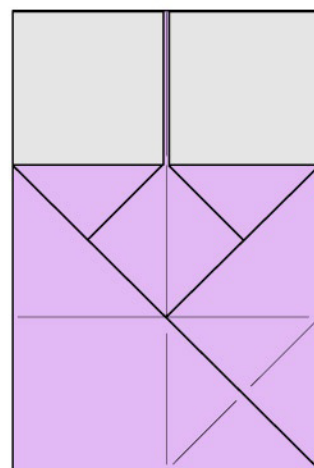

10

Modulo ultimato

UNIONE DEI MODULI

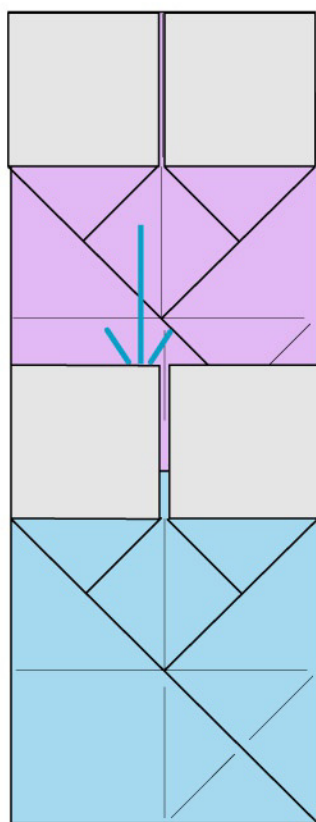

1

Intascate un modulo nell'altro

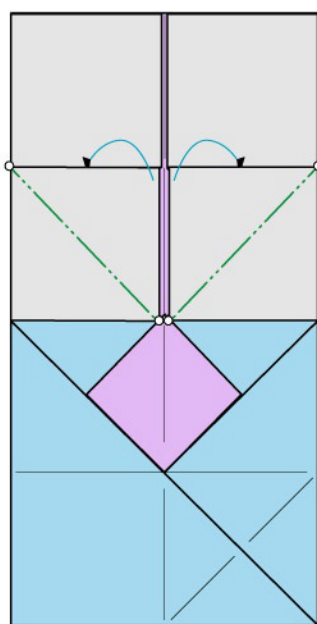

2

Mediante 2 pieghe a monte
boccate l'unione

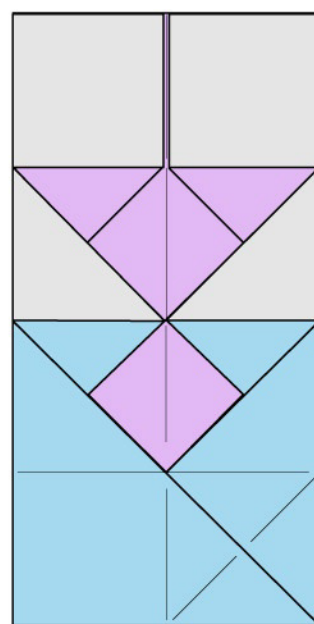

3

Unione completata

NASTRO "F"89

Questo nastro appartiene ad una serie già pubblicata diversi anni fa.
Adotta un sistema costruttivo differente dagli altri, infatti i moduli si agganciano rovesciati l'uno rispetto all'altro e devono essere bloccati sui due lati.
Adoperare fogli quadrati monocolori

This tape belongs to a series already released several years ago.
it adopts a different construction system from the others, in fact the modules are hooked upside down with respect to each other and must be blocked on both sides.
Use one-color square sheets

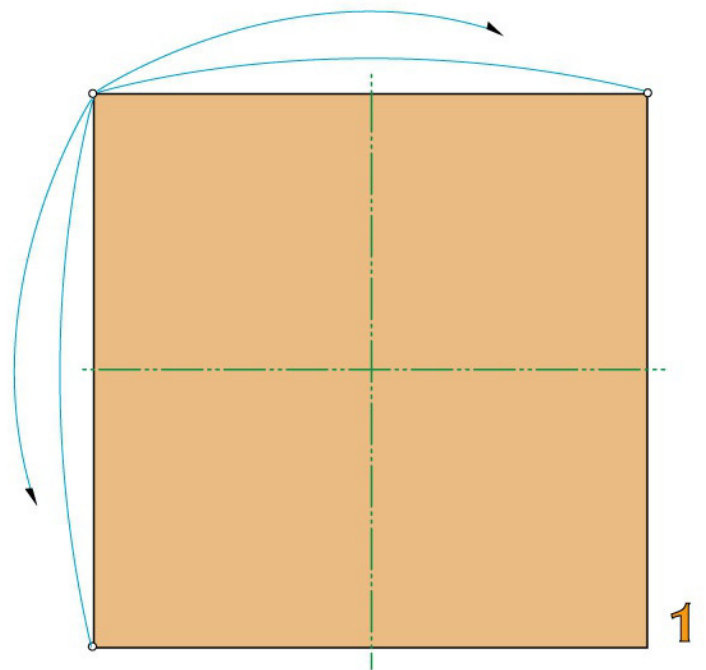
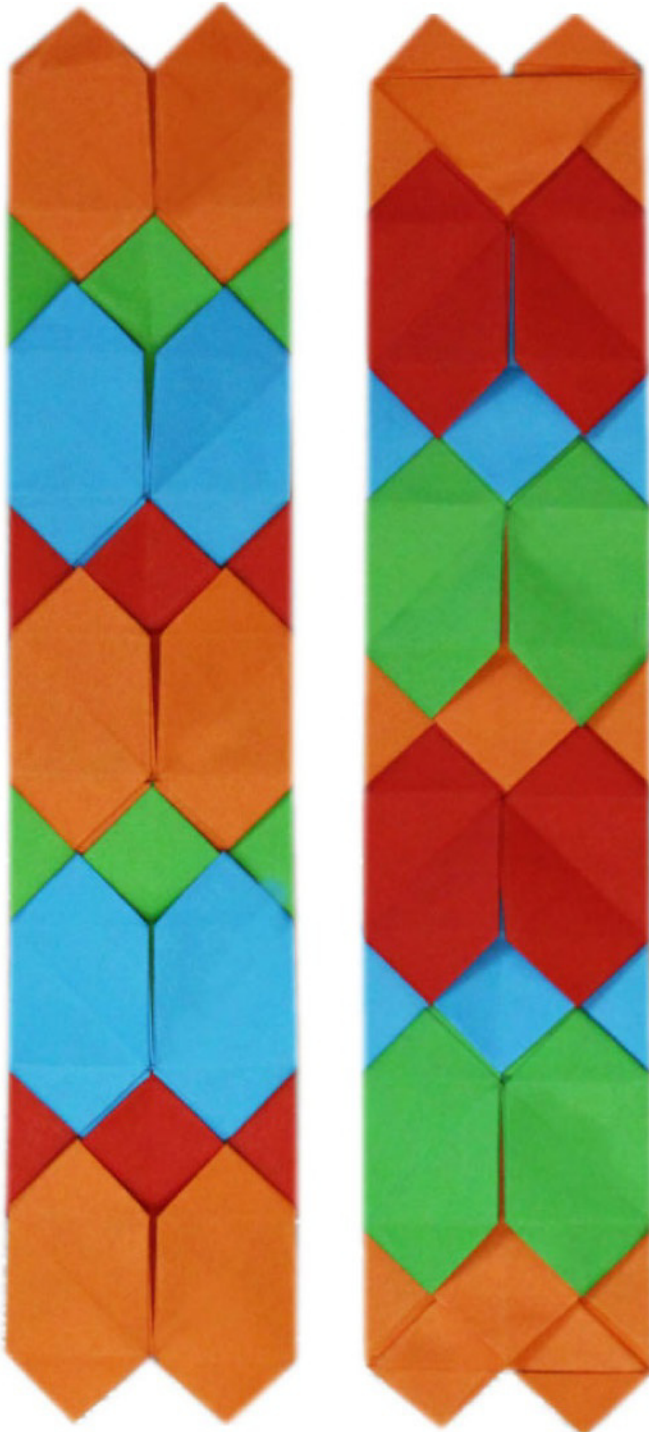

2 pieghe a monte

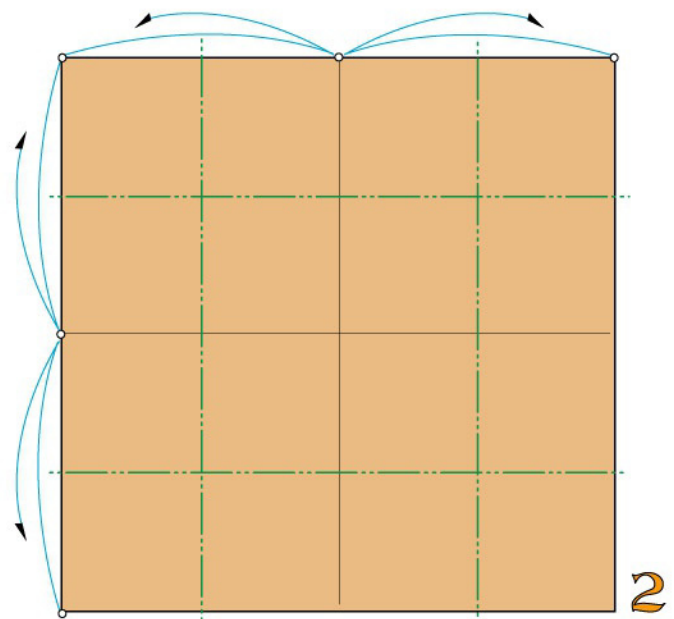

4 pieghe a monte

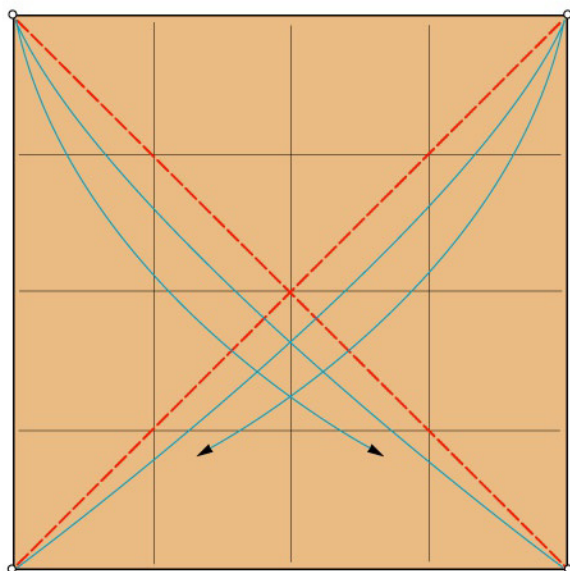

2 pieghe diagonali a valle

3

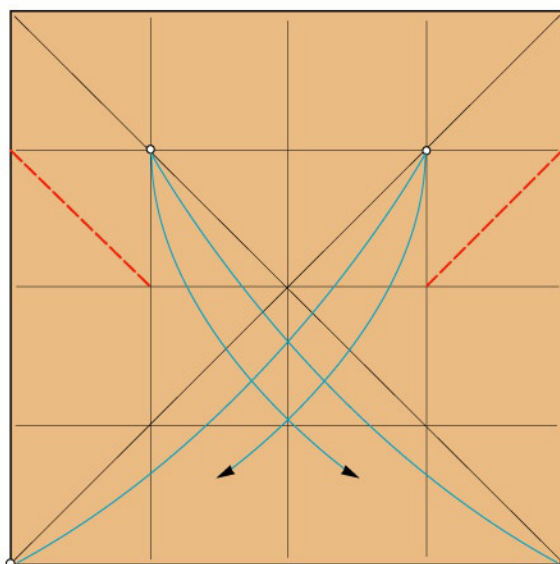

2 pieghe diagonali a valle

4

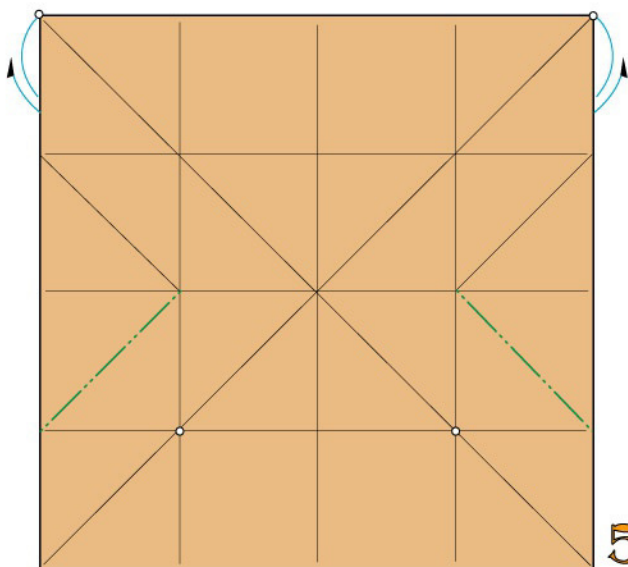

2 pieghe diagonali a monte

5

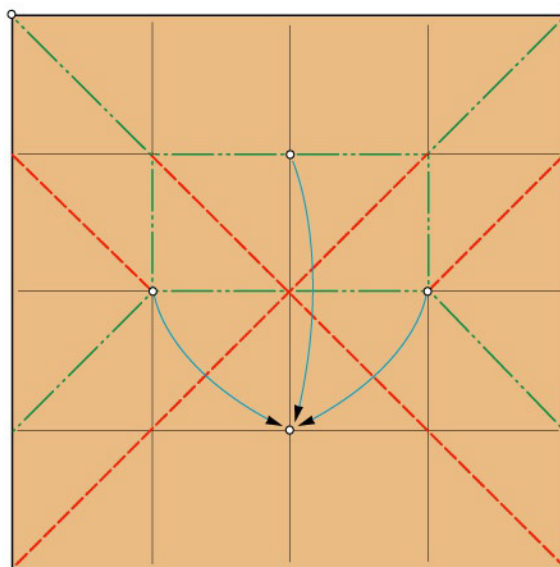

Ripiegate a valle e a monte

6

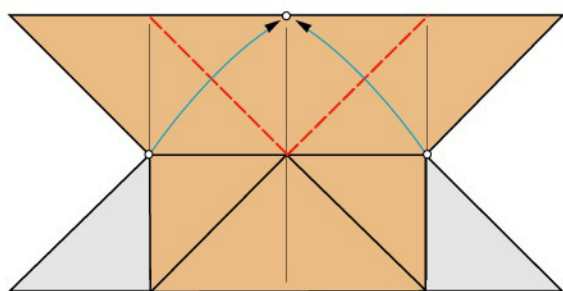

2 pieghe a valle e ribaltate

7

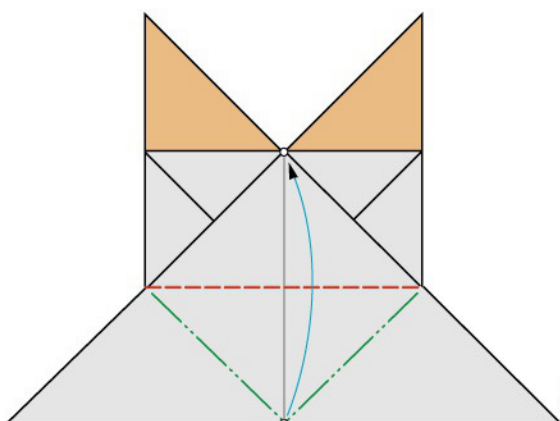

8



2 pieghe a monte, 2 a valle non visibili e ripiegate a valle

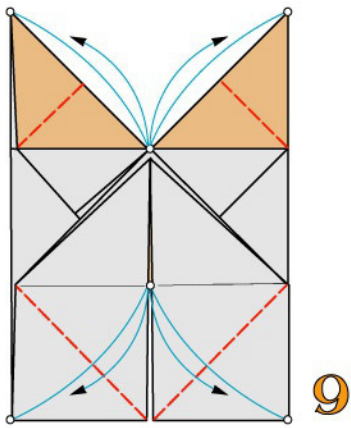

4 pieghe a valle

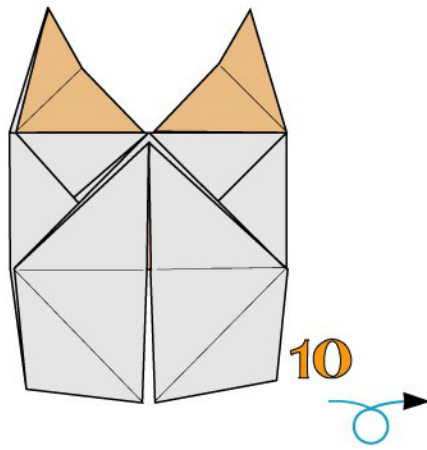

Modulo ultimato. Ribaltate

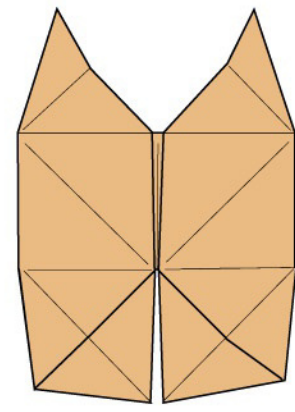

Retro del modulo

UNIONE DEI MODULI

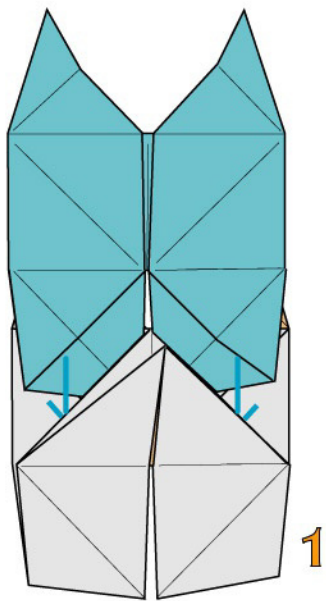

Inserite la parte inferiore di un modulo entro un altro uguale ma ribaltato

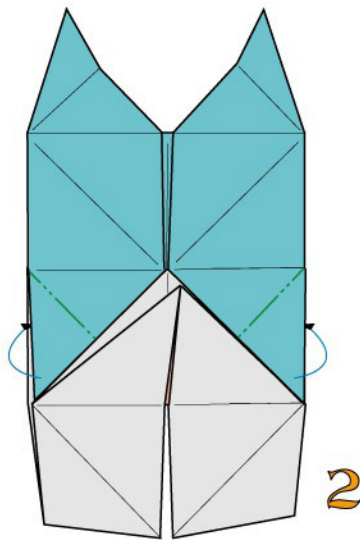

2 pieghe a monte e intascate

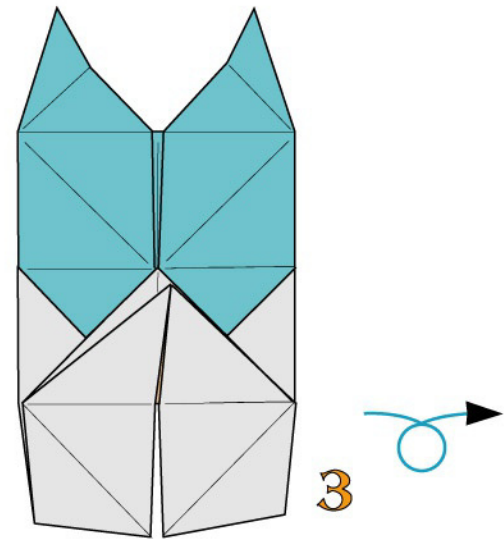

Ribaltate

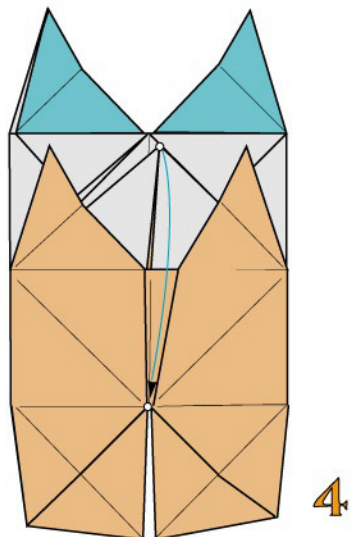

Abbassate il vertice indicato inserendolo all'interno del modulo inferiore

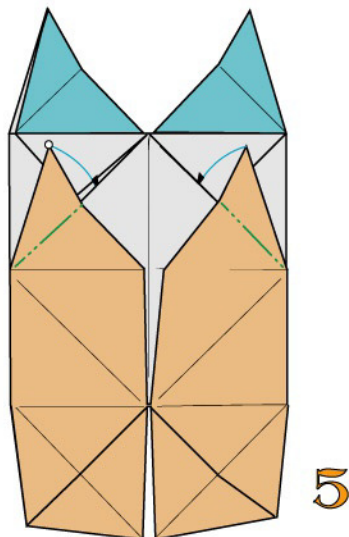

2 pieghe a monte e intascate

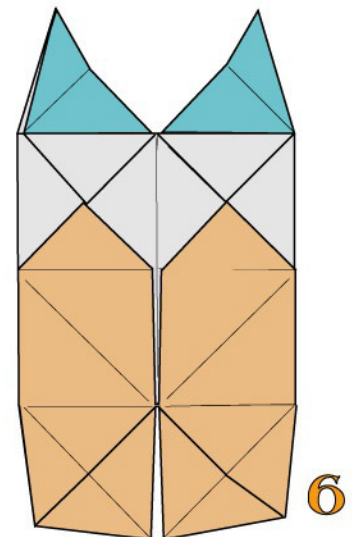

Bloccaggio ultimato

NASTRO "G" 89

Adoperate fogli quadrati monocolori

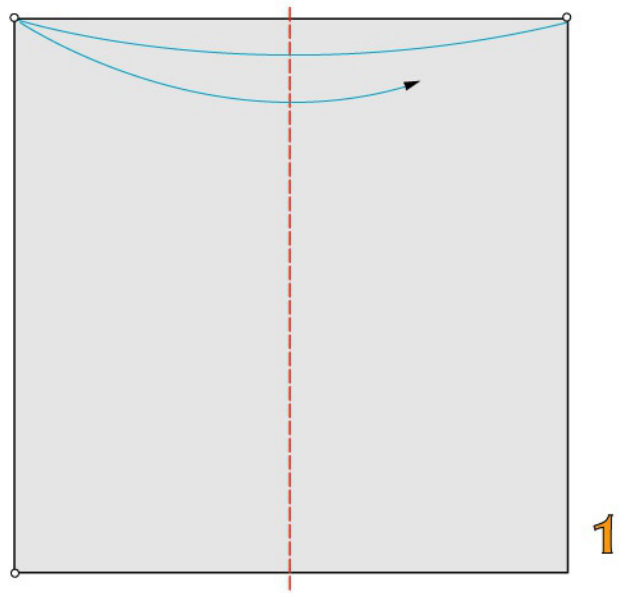

1 piega a valle

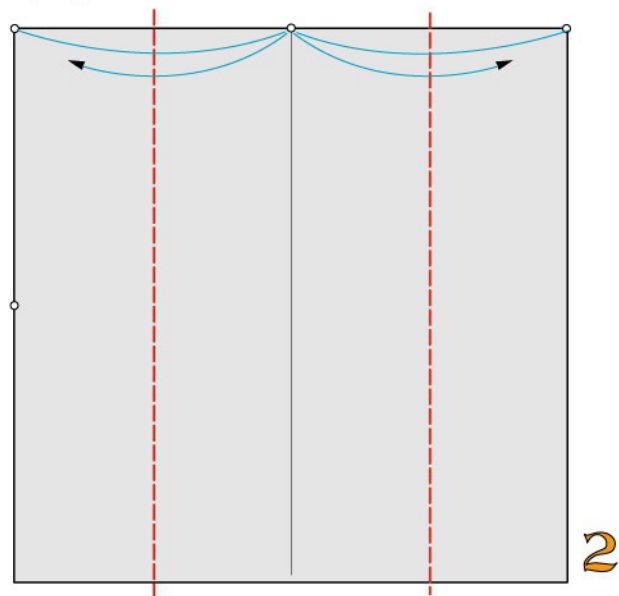

2 pieghe a valle

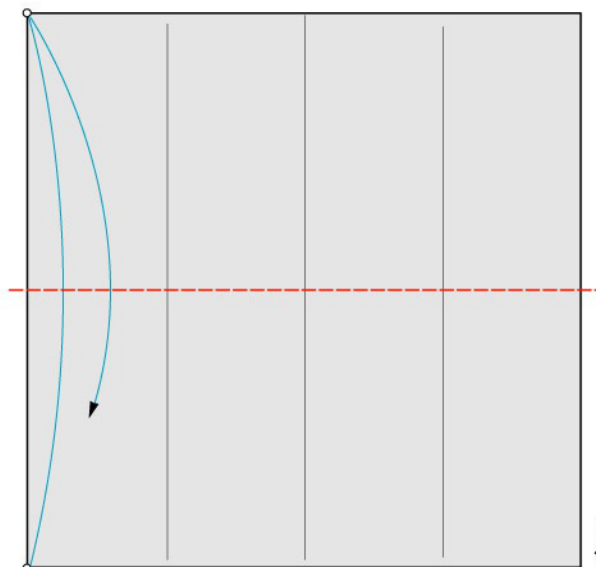

1 piega a valle



3

1 piega a monte

4

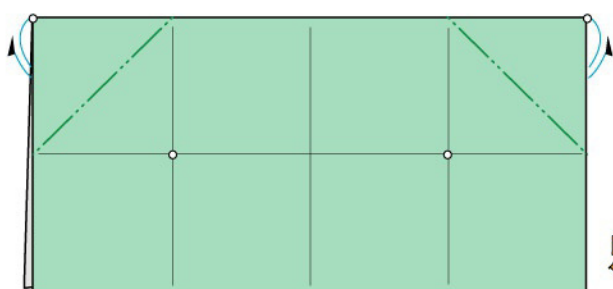

2 pieghe diagonali a monte

5

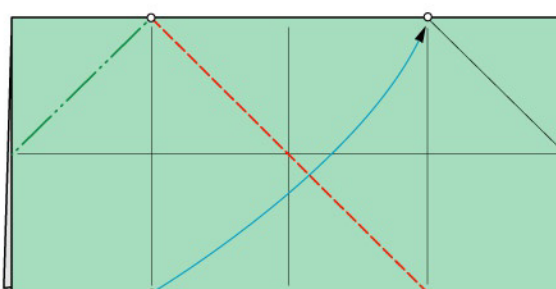

1 piega a valle solo sulla superficie in vista e ripiegate a monte

6

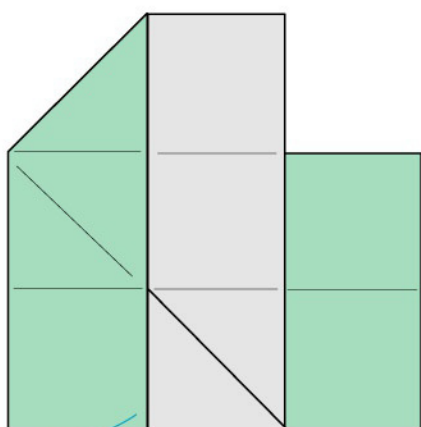

7

Riportate alla posizione della figura precedente

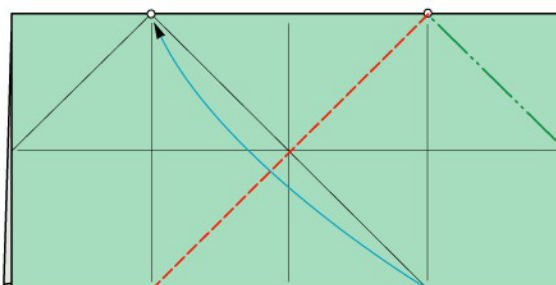

1 piega a valle solo sulla superficie in vista e ripiegate a monte

8

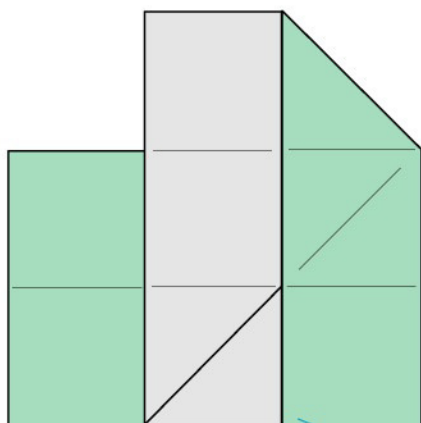

9

Riportate alla posizione della figura precedente

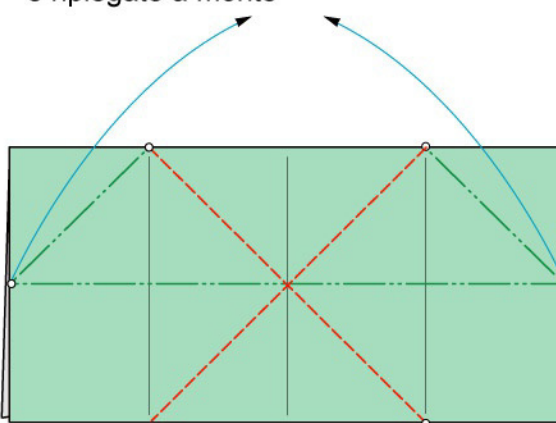

Ripiegate a valle e a monte

10

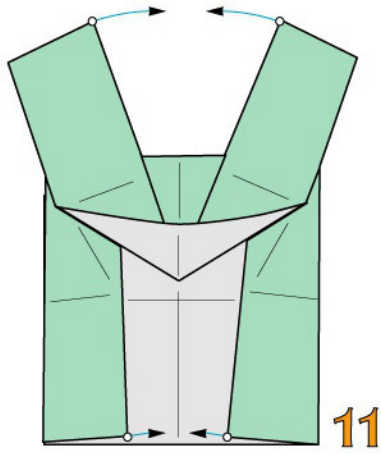

11

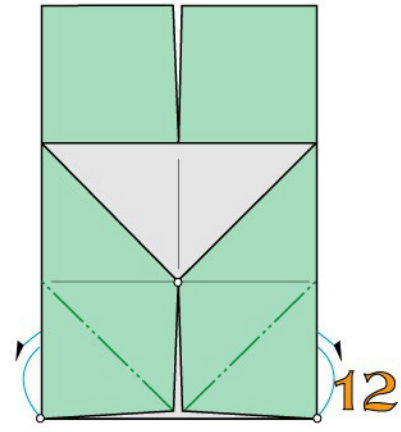

12

2 pieghe diagonali a monte

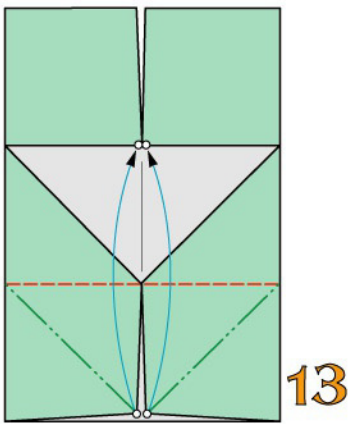

13

Ripiegate a valle e a monte

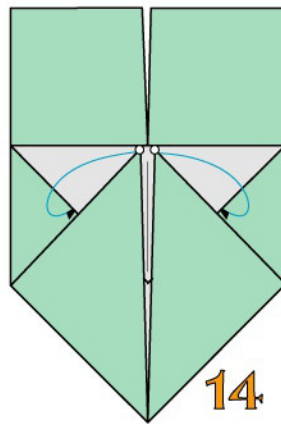

14

Inserite i 2 vertici indicati nelle tasche sottostanti

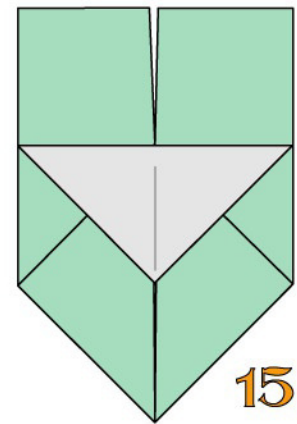

15

Modulo ultimato

UNIONE DEI MODULI

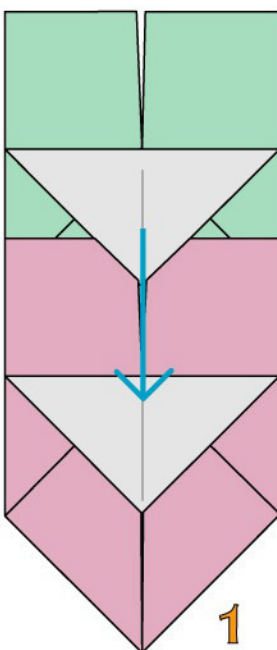

1

Inserite un modulo nell'altro

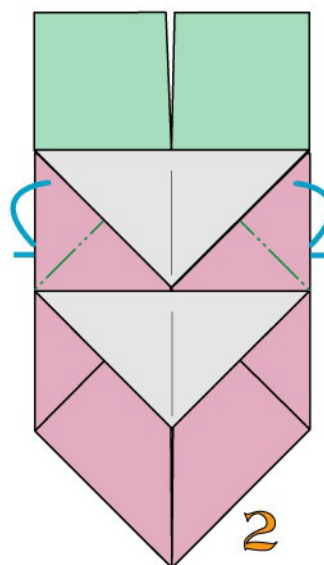

2

con 2 pieghe a monte intascate e bloccate l'unione

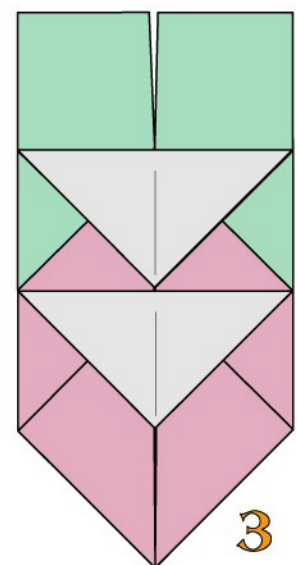

3

Unione completata

NASTRO "H" 89

I moduli si agganciano rovesciati l'uno rispetto l'altro.
Adoperate fogli quadrati monocolori.

The modules hook upside down with respect to each other.
Use one-color square sheets.

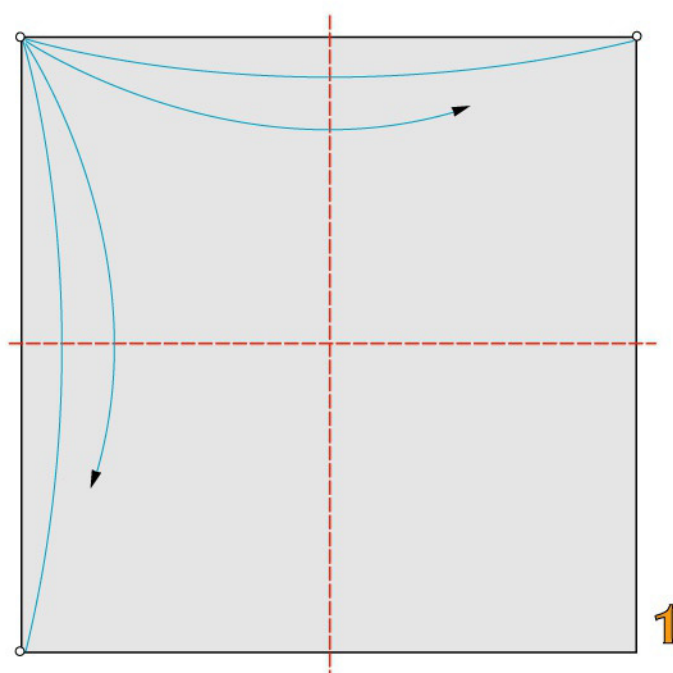
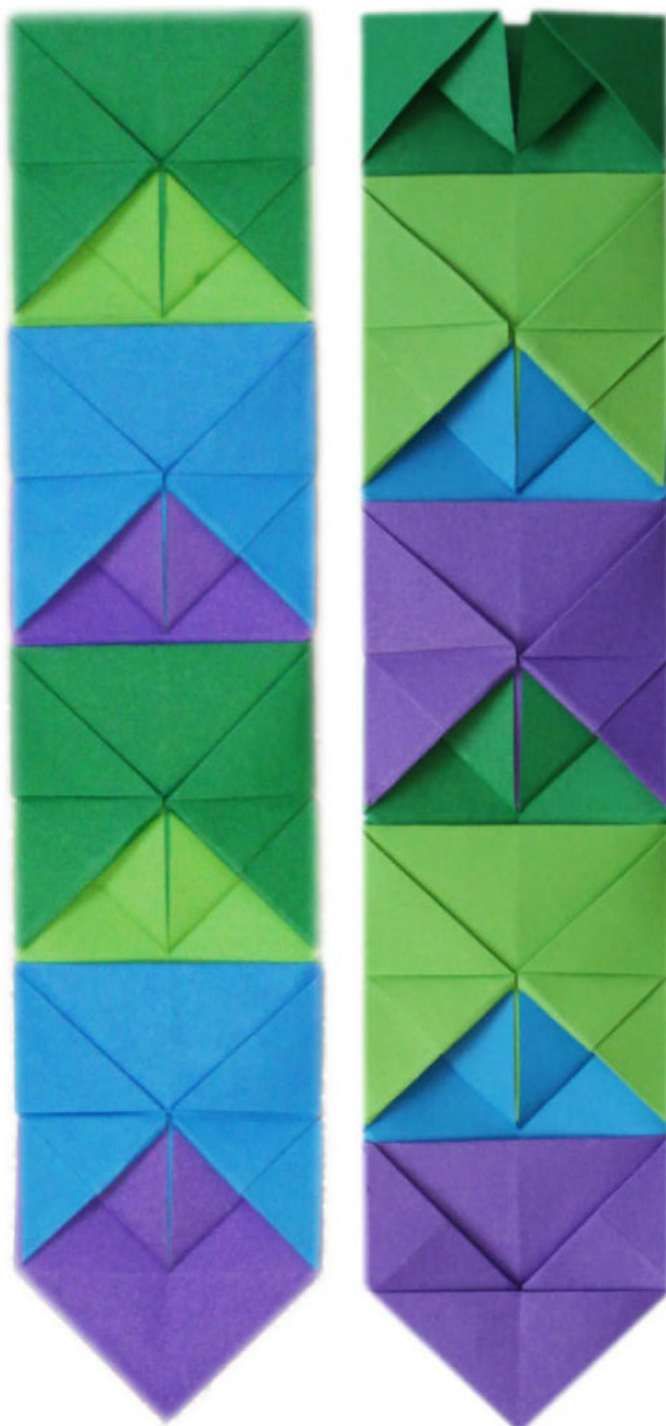

2 pieghe a valle

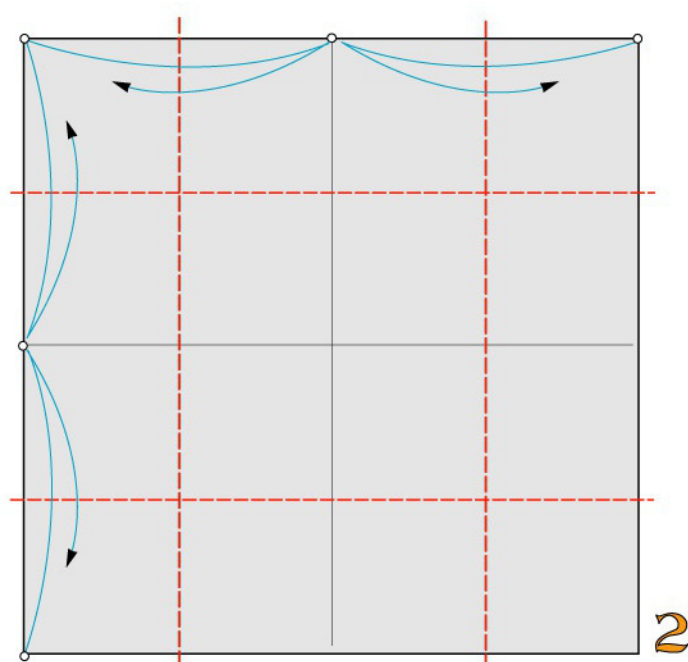

4 pieghe a valle

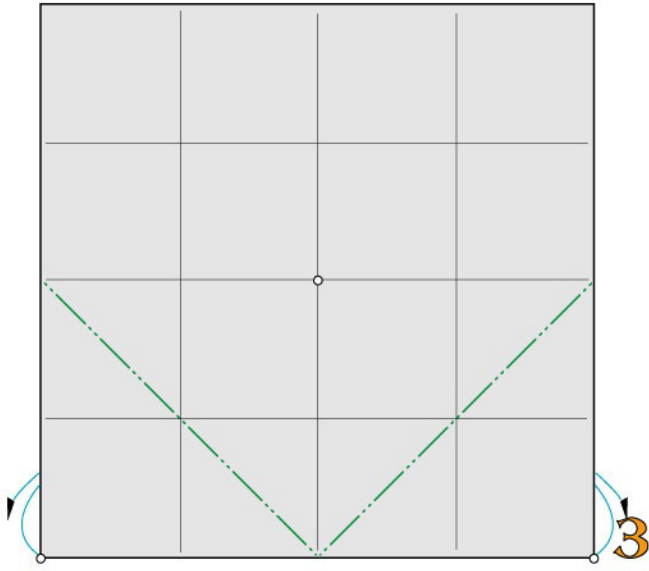

2 pieghe diagonali a monte

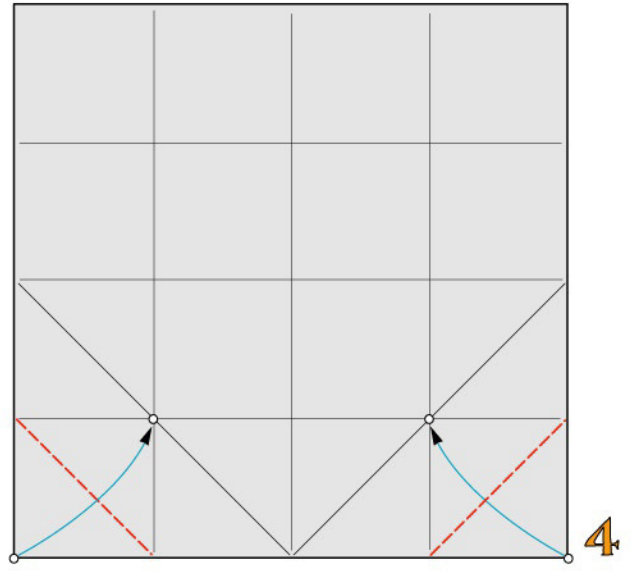

2 pieghe diagonali a valle

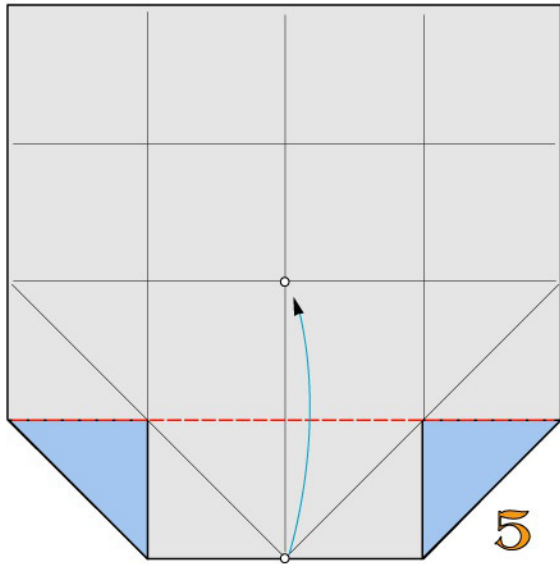

Ripiegate a valle

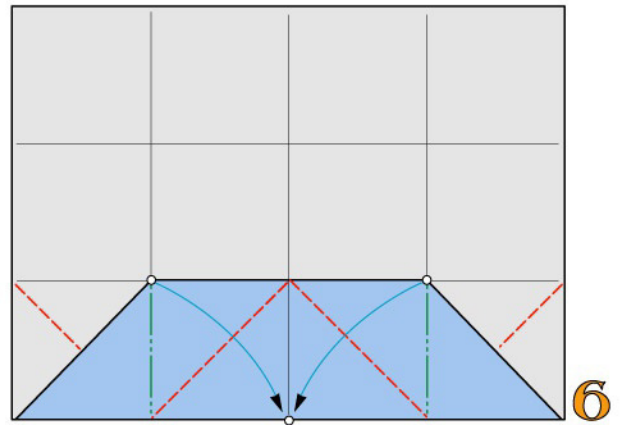

2 pieghe diagonali a valle e ripiegate a valle e a monte

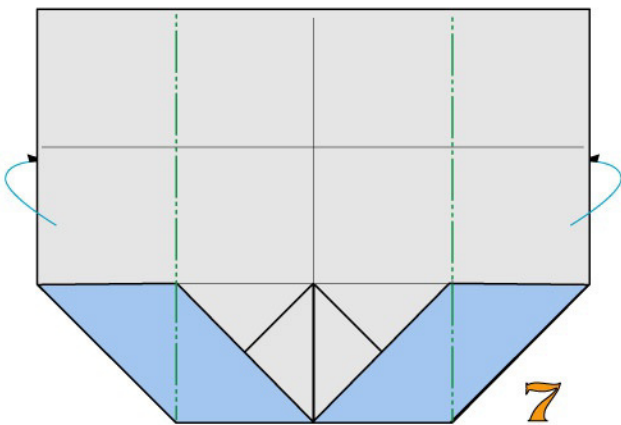

2 pieghe a monte e ribaltate

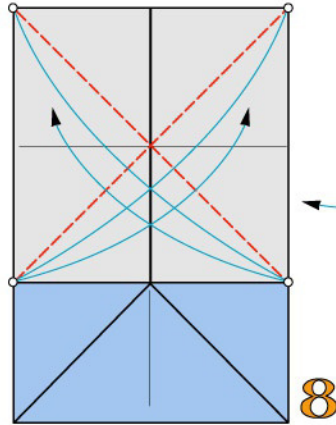

2 pieghe diagonali a valle

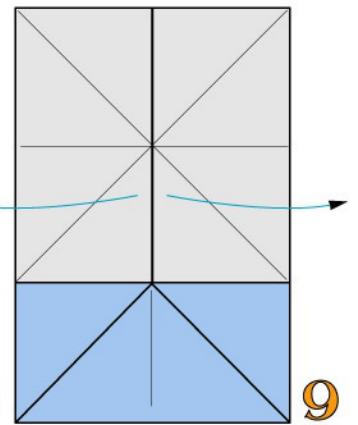

Aprite

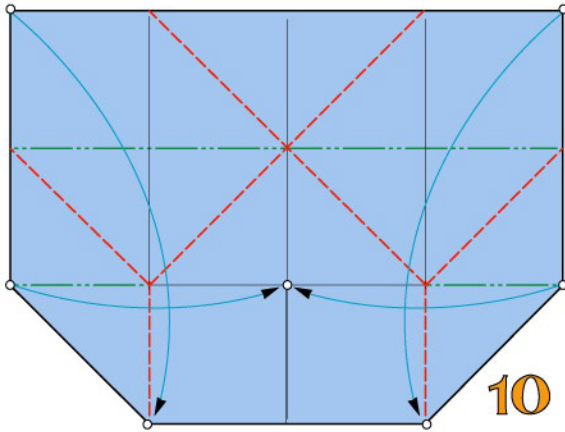

Ripiegate a valle e a monte

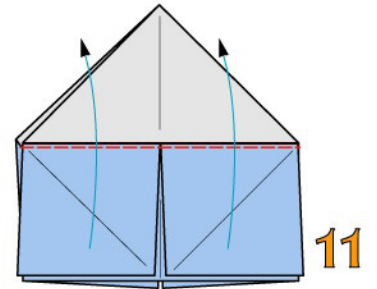

Ripiegate a valle

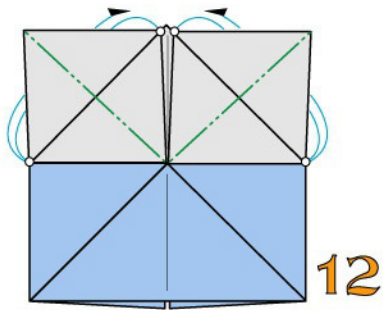

2 pieghe diagonali a monte

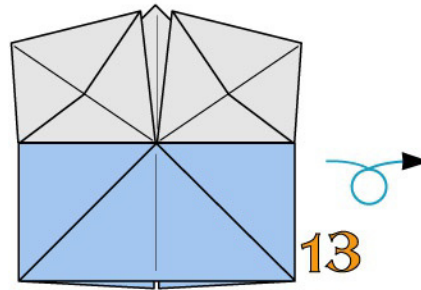

Modulo ultimato. Ribaltate

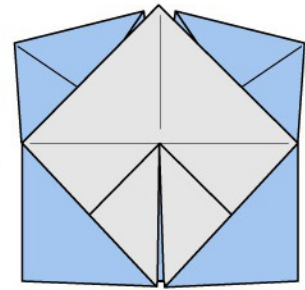

UNIONE DEI MODULI

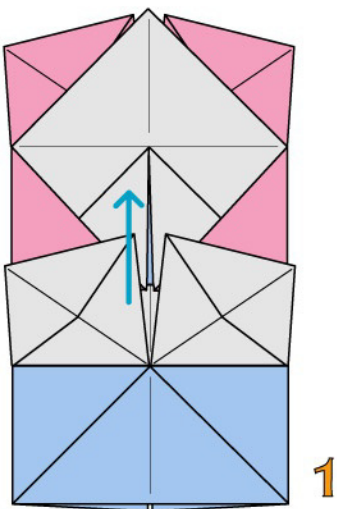

Unite un modulo ad un altro ma ribaltato

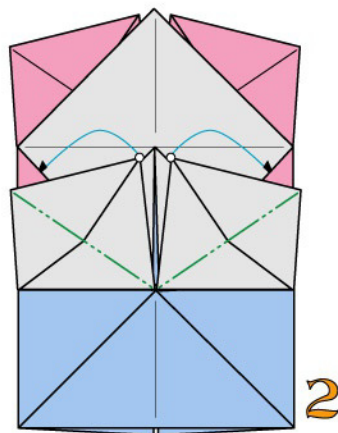

Ripiegando a monte intascate e bloccate l'unione

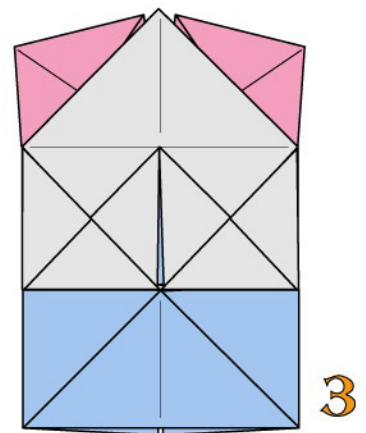

Unione completata

NASTRO "I" 89

Adoperate fogli quadrati monocolori

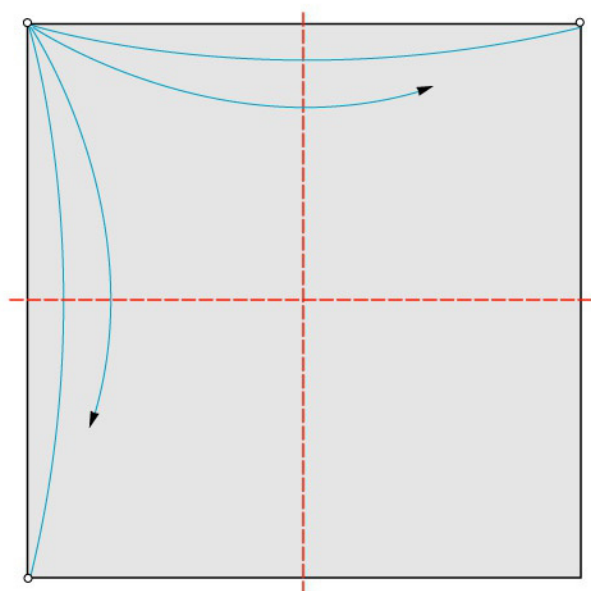

1

2 pieghe a valle

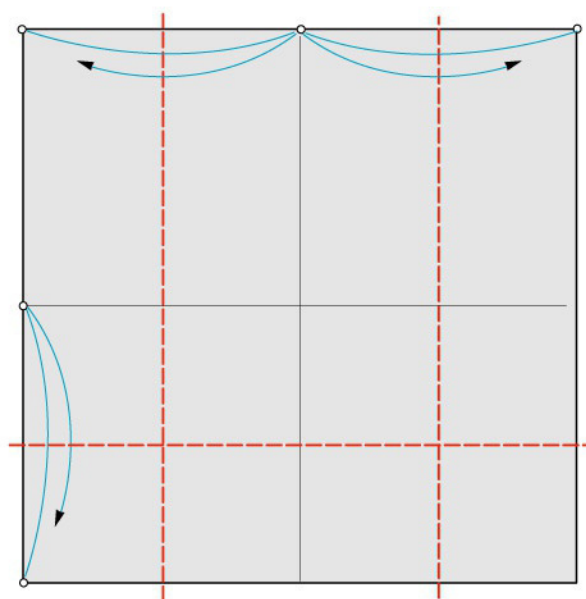

2

3 pieghe a valle

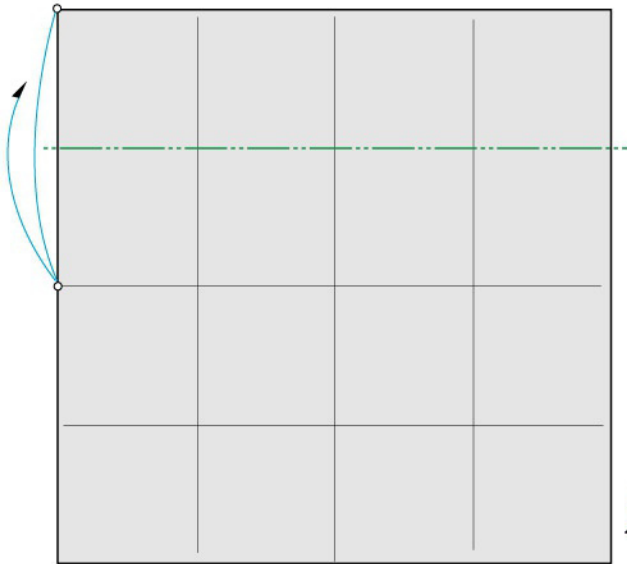

1 piega a monte

3

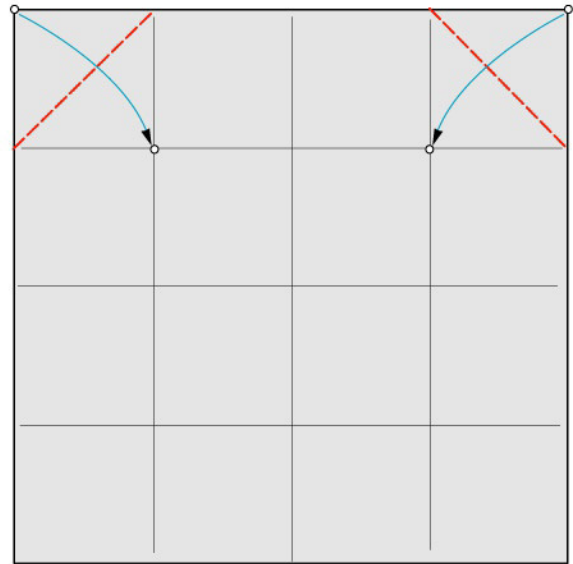

2 pieghe diagonali a valle

4

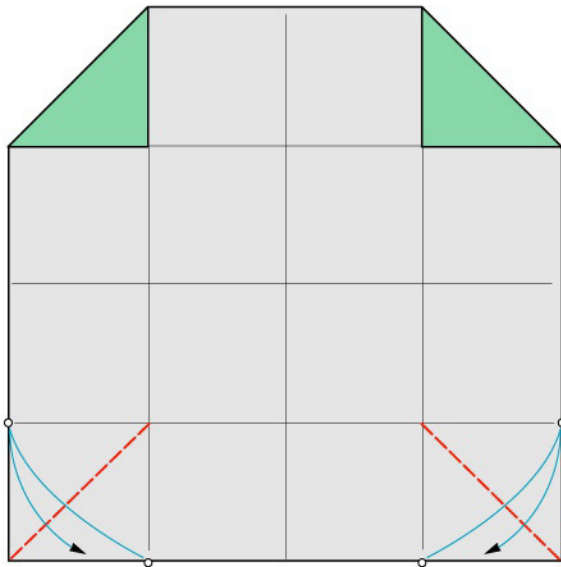

2 pieghe diagonali a valle

5

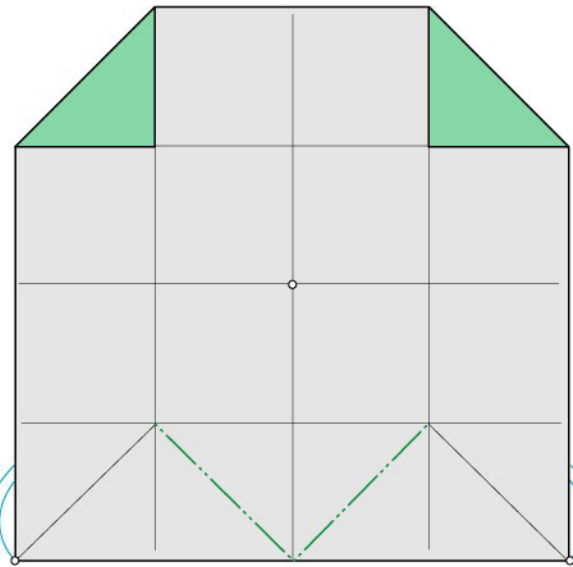

2 pieghe diagonali a monte

6

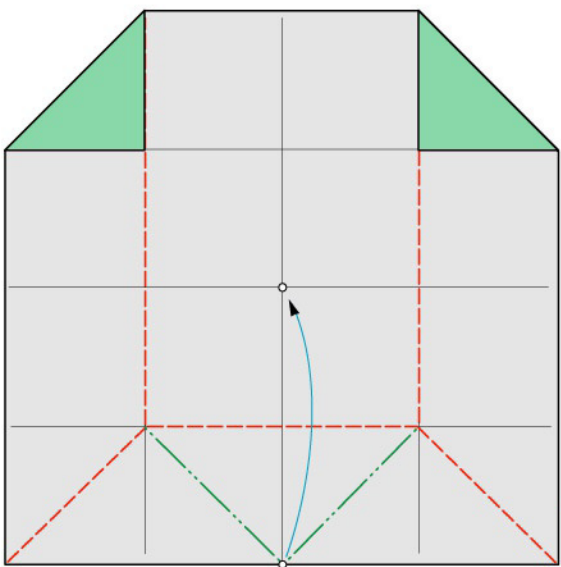

Ripiegate a valle e a monte

7

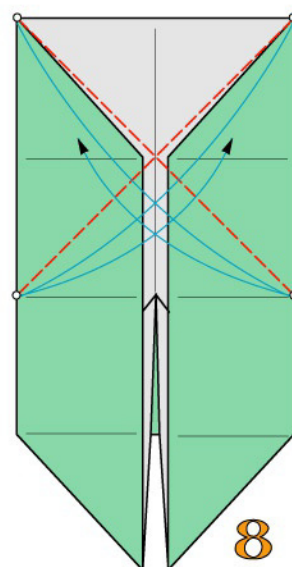

2 pieghe diagonali a valle

8

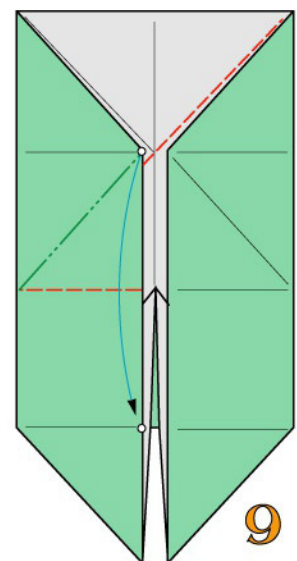

Ripiegate a valle e a monte

9

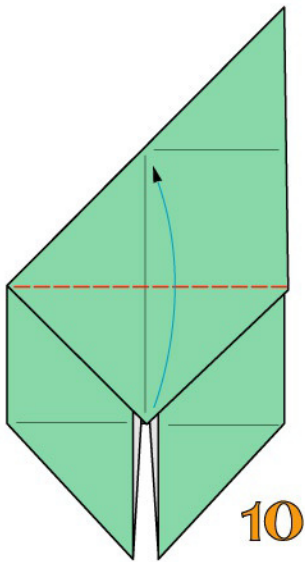

10

Ripiegate a valle

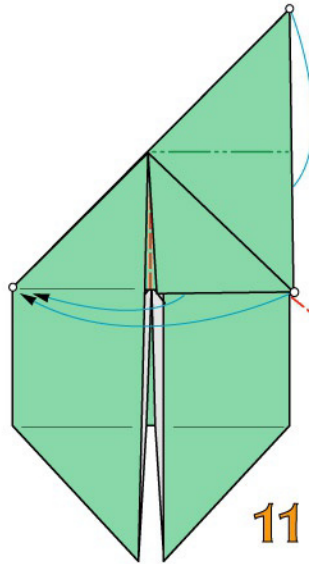

11

Ripiegate a valle e a monte

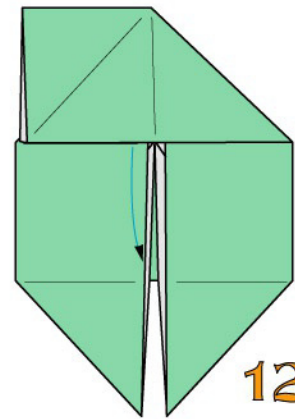

12

Estraete

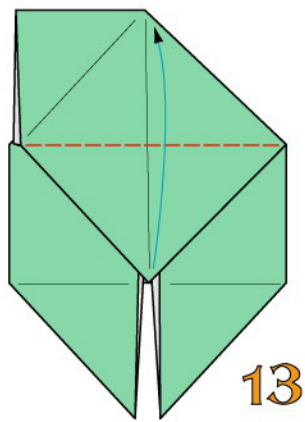

13

Ripiegate a valle

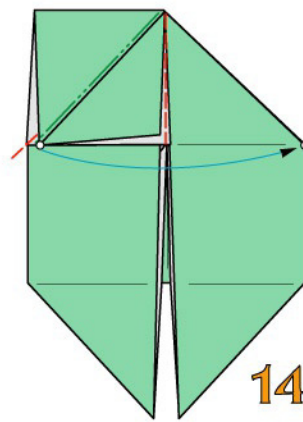

14

Ripiegate a valle e a monte

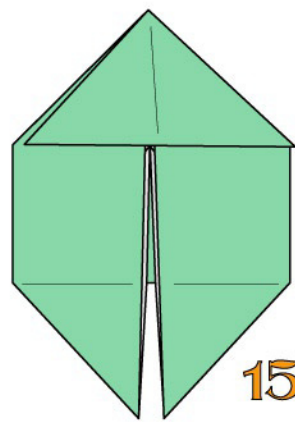

15

Modulo ultimato

UNIONE DEI MODULI

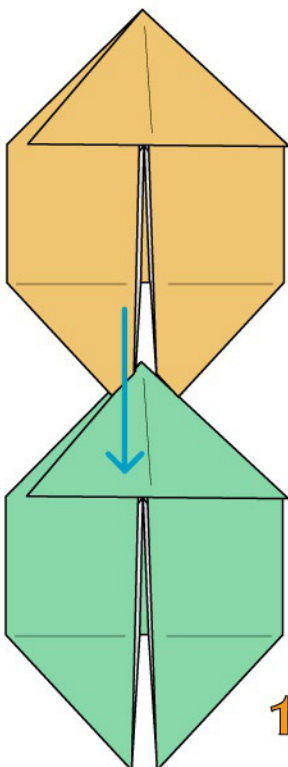

1

Inserite un modulo nell'altro

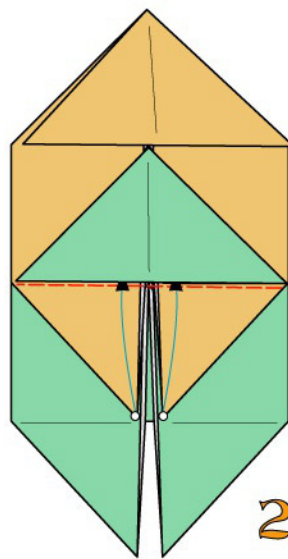

2

Intascate i 2 vertici indicati bloccando l'unione

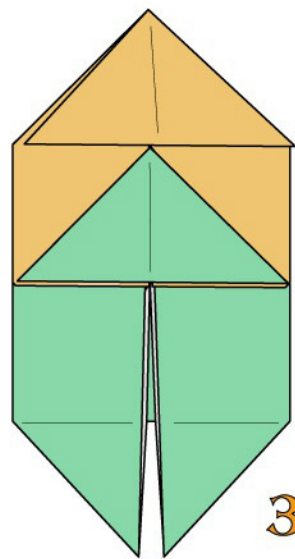

3

Unione completata

NASTRO "L" 89

Si realizza unendo alternativamente moduli "Fiore A" e moduli "Foglia"
Costruite i primi con fogli quadrati bicolori e i secondi con fogli monocolori.

It is made by combining "Fiore A" modules and "Foglia" modules alternately.
Build the former with two-color square sheets and the latter with single-color sheets



COSTRUZIONE DEL MODULO "FIORE A"

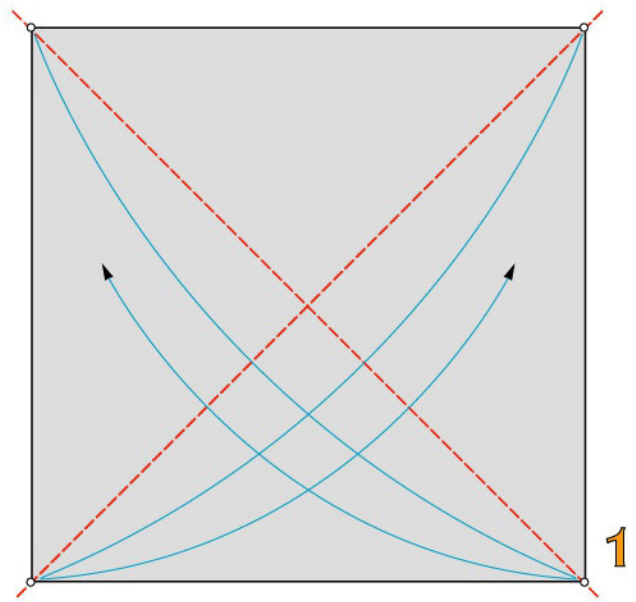

2 pieghe diagonali a valle

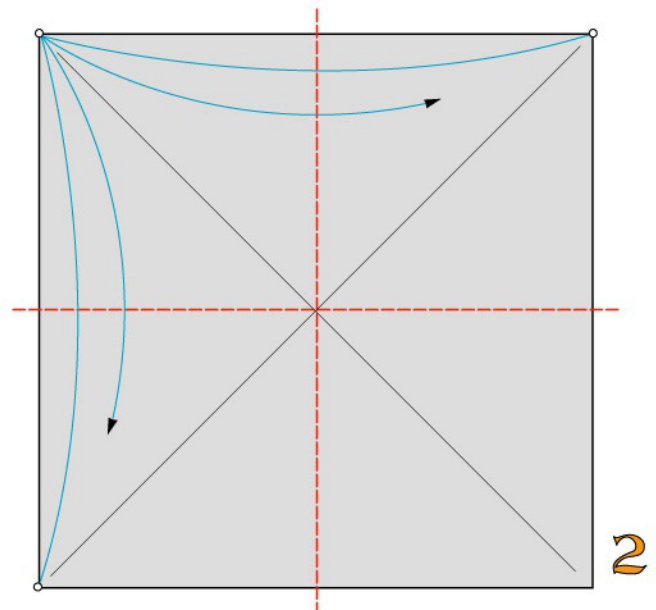

2 pieghe a valle

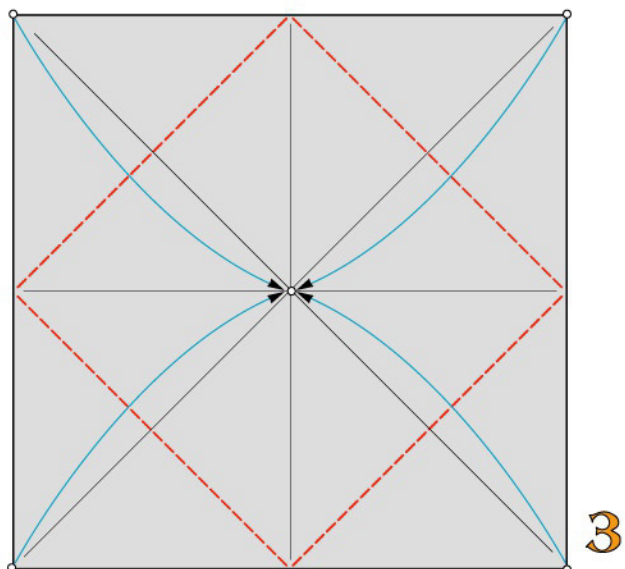

4 pieghe diagonali a valle

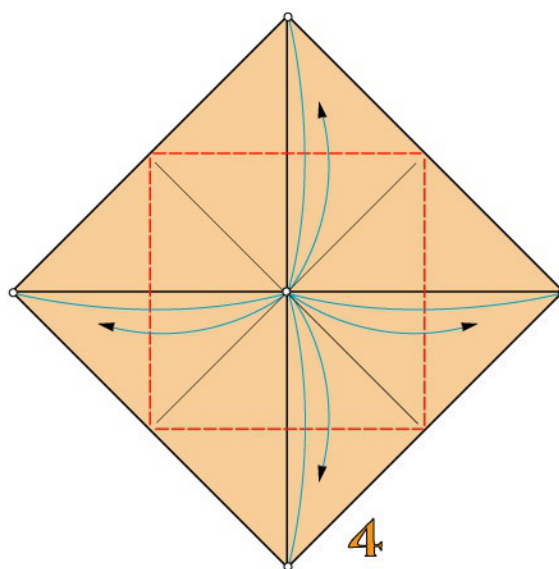

4 pieghe diagonali a valle

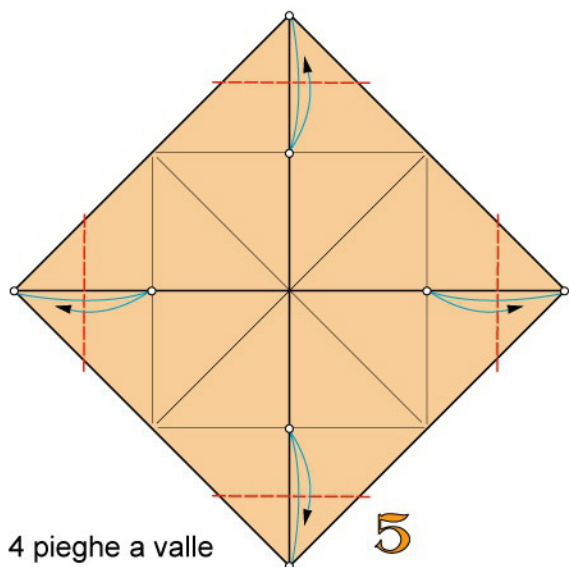

4 pieghe a valle

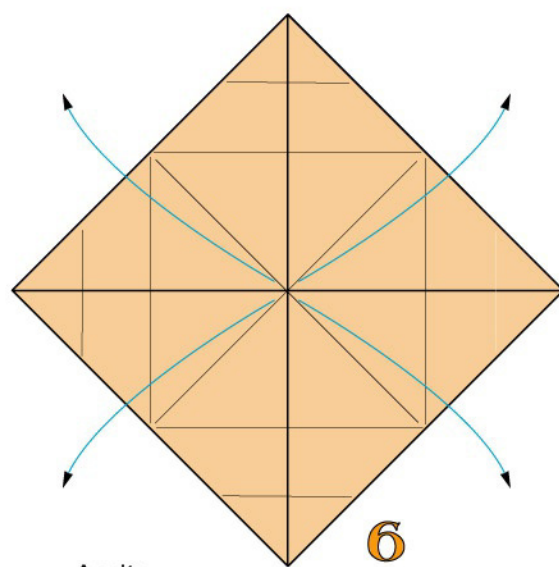

Aprite

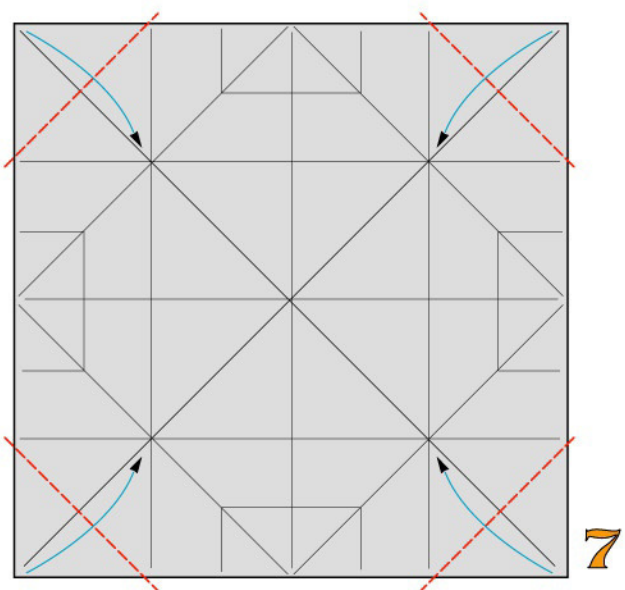

4 pieghe a valle

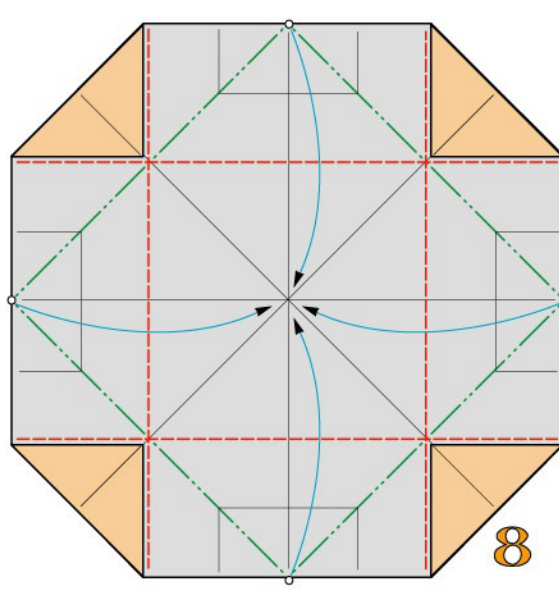

Ripiegate a valle e a monte

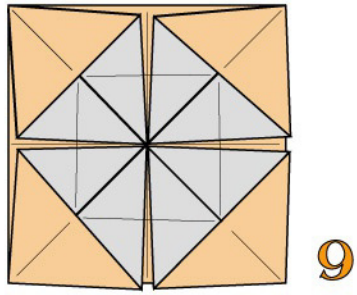

Modulo "Fiore A" ultimato

COSTRUZIONE DEL MODULO "FOGLIA"

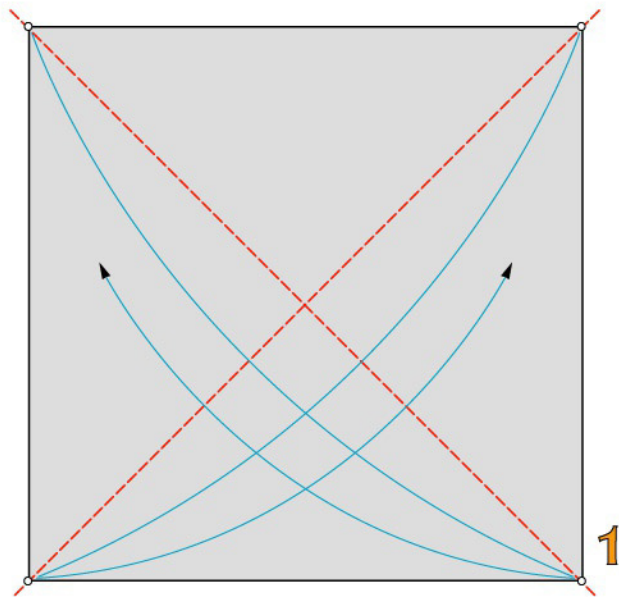

2 pieghe diagonali a valle

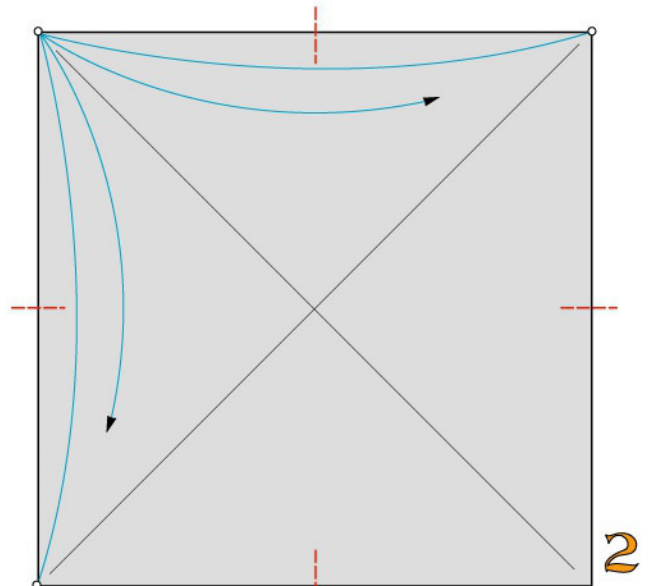

4 piccole pieghe a valle

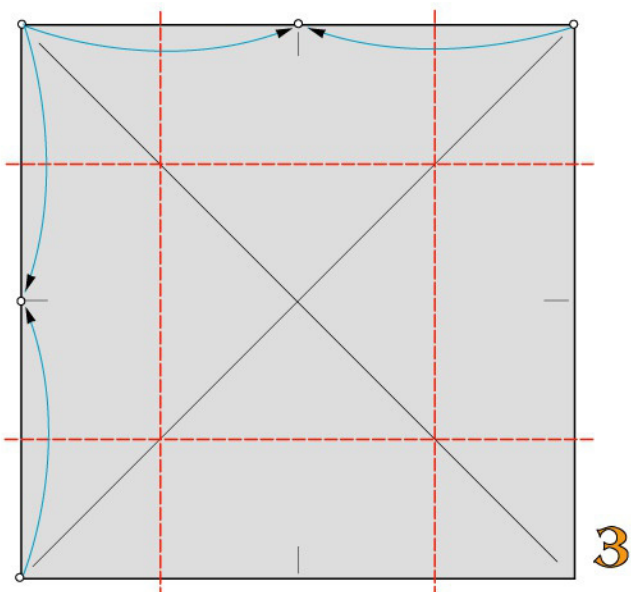

4 pieghe a valle

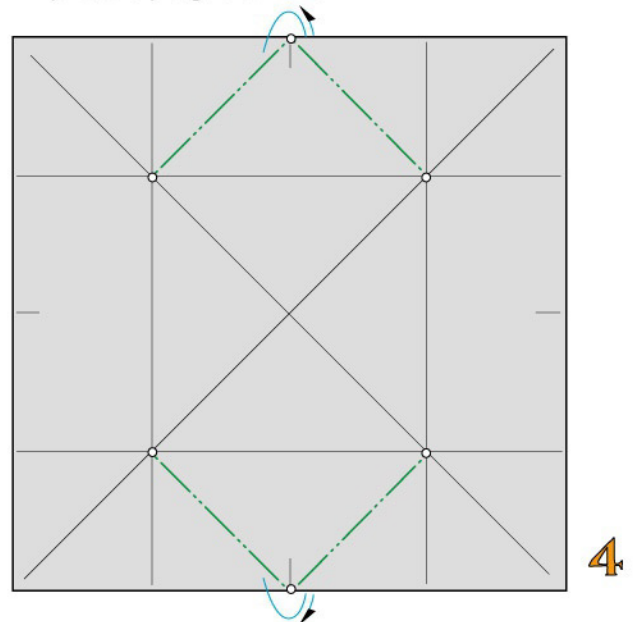

4 pieghe a monte

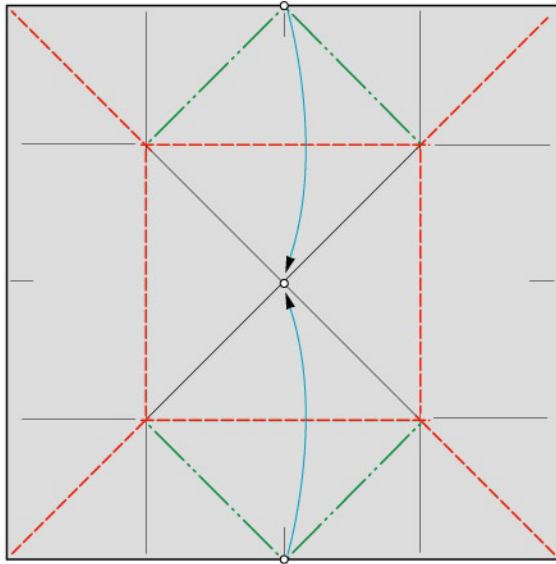

5

Ripiegate a valle e a monte

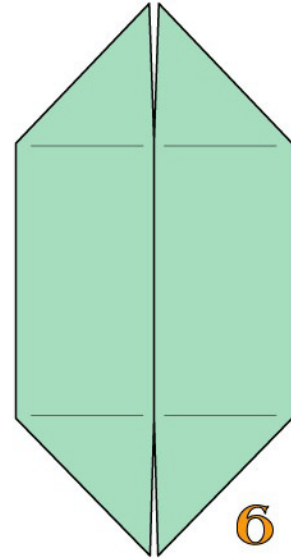

6

Modulo "Foglia" completato

UNIONE DEI MODULI

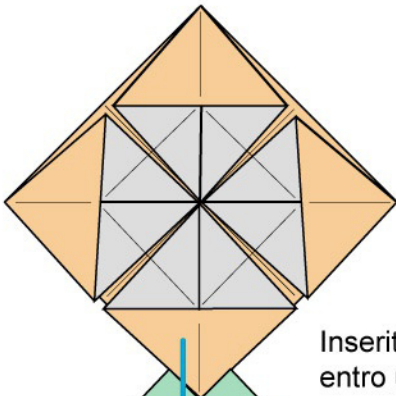

Inserite un modulo Foglia
entro un modulo Fiore

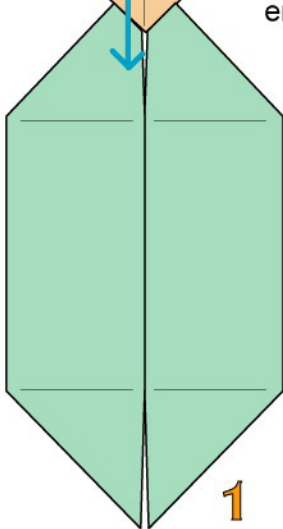

1

2 pieghe a monte
e intascate bloccando
l'unione

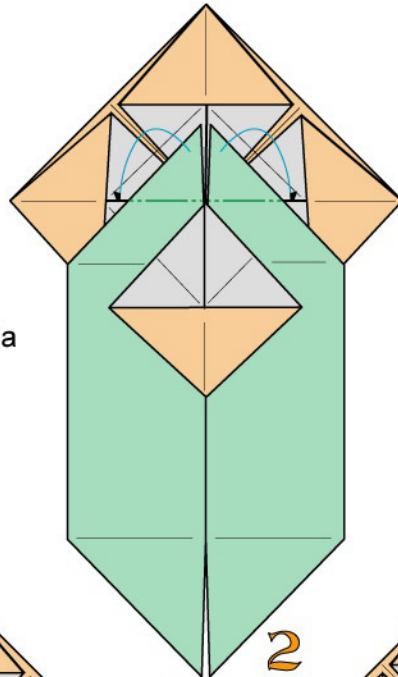

2 pieghe a monte
e intascate

2

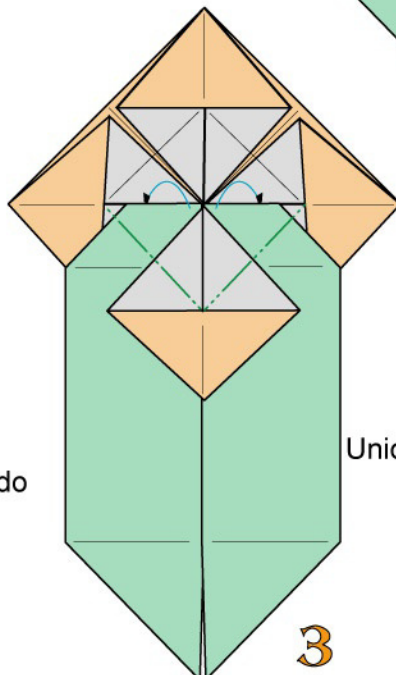

Unione completata

3

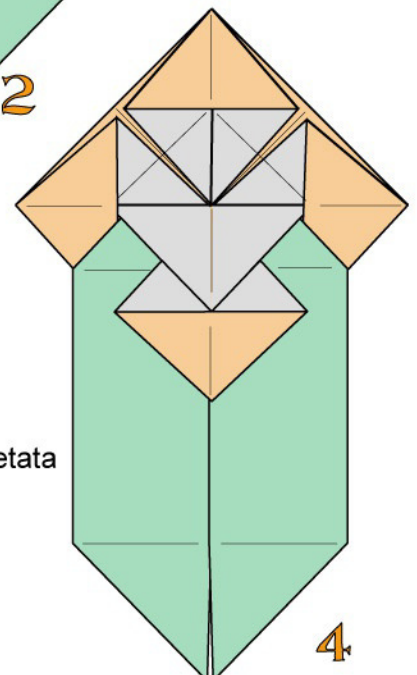

4

NASTRO "M" 89

Si realizza unendo alternativamente moduli "Fiore B" e moduli "Foglia" del nastro "L".
Adoperate fogli quadrati monocolori per i moduli Foglia e bicolori per i moduli "Fiore B"

It is made by combining "Fiore B" modules and "Foglia" modules alternately of the "L" band.
Build the former with two-color square sheets and the latter with single-color sheets



COSTRUZIONE DEL MODULO "FIORE B"

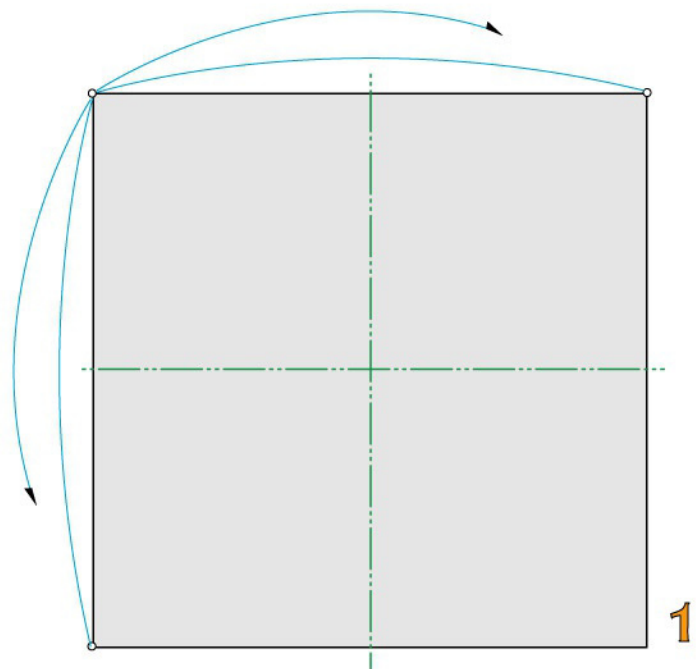

2 pieghe a monte

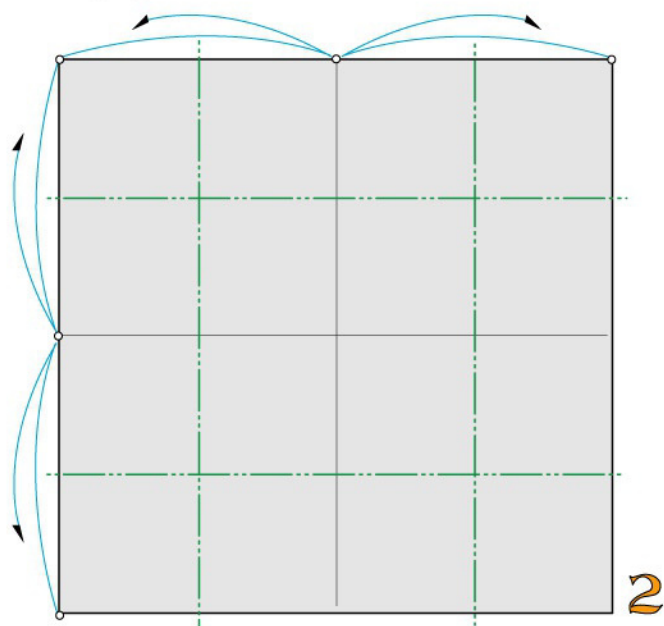

4 pieghe a monte

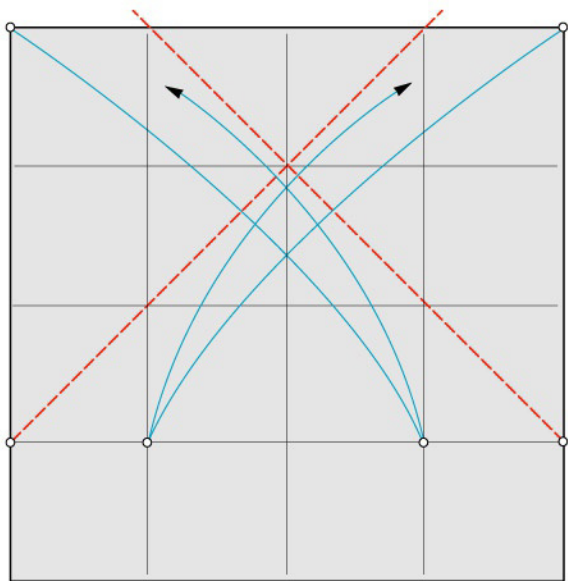

3

2 pieghe diagonali a valle

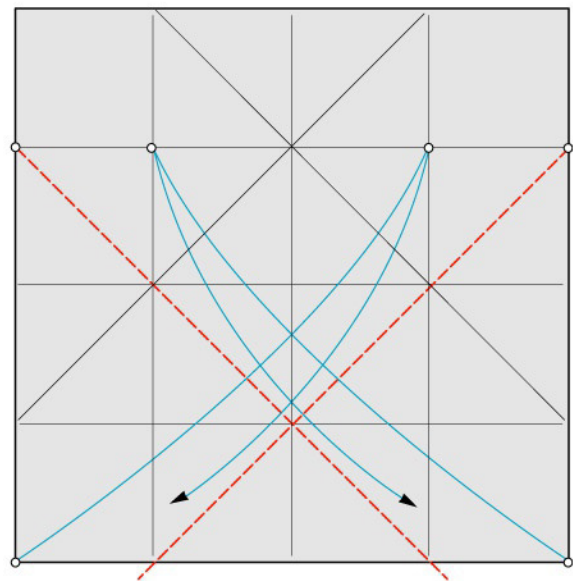

4

2 pieghe diagonali a valle

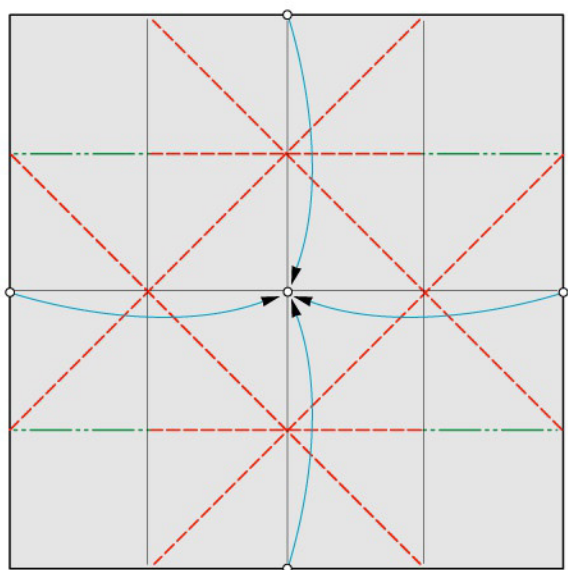

5

Ripiegate a valle a monte

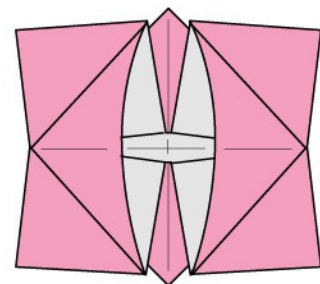

6

Modulo "Fiore B" completato

UNIONE DEI MODULI

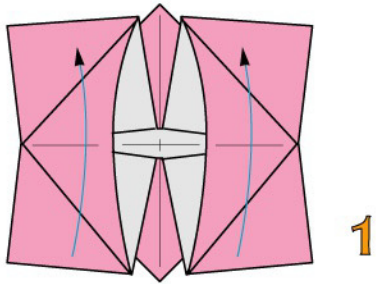

1

Chiudete il modulo "Fiore B"

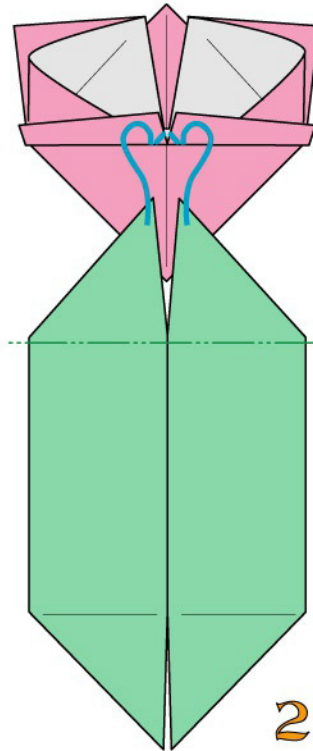

2

Inserite il modulo "Fiore B"
all'interno del modulo Foglia.
Intascate i vertici indicati per
bloccare l'unione

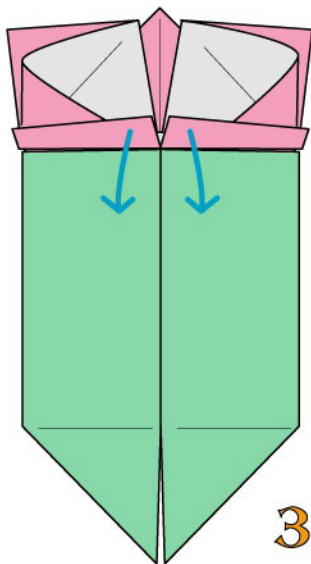

3

Riaprite il modulo "Fiore B"

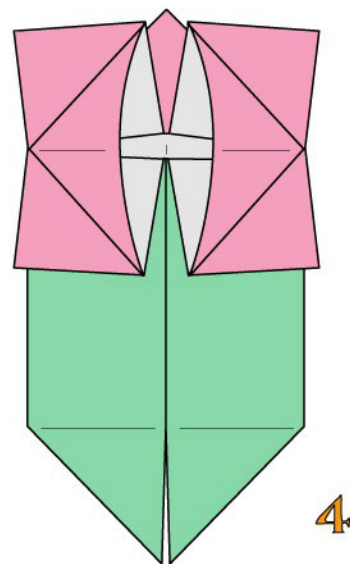

4

Unione completata

NASTRO "N" 89

Si realizza unendo alternativamente moduli "Fiore B" e moduli "Foglia"

Adoperate fogli quadrati monocolori



UNIONE DEI MODULI

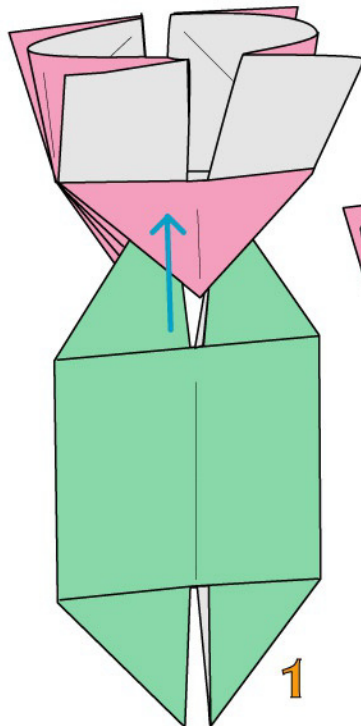

1

Inserite un modulo "Foglia" ribaltato in un modulo "Fiore B" chiuso.

Insert an upside down "Foglia" module into a closed "Flower B" module.

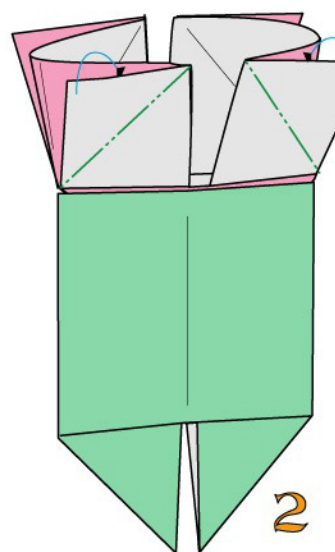

2

2 pieghe a monte sovrapponendo i vertici interni dell'altro modulo

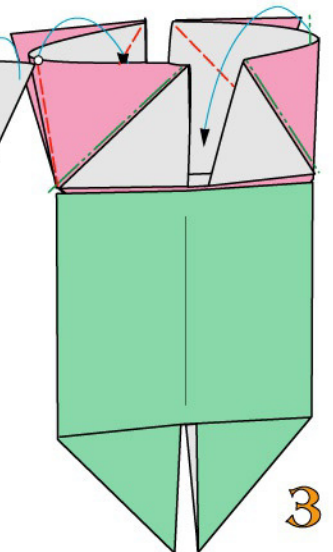

3

2 pieghe rovesce interne

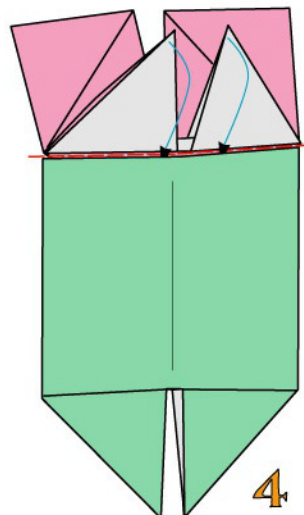

4

Intascate i 2 vertici indicati bloccando l'unione

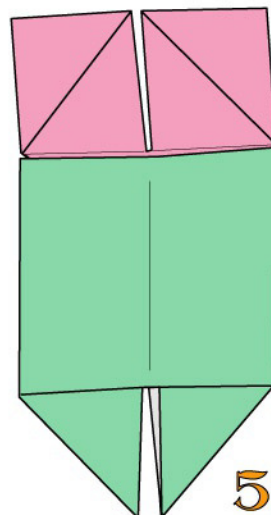

5

Unione completata



NASTRO "O"

Questo modulo consente la costruzione di nastri 3D, mediante l'unione di moduli-base e moduli d'angolo
Adoperate fogli quadrati monocolori

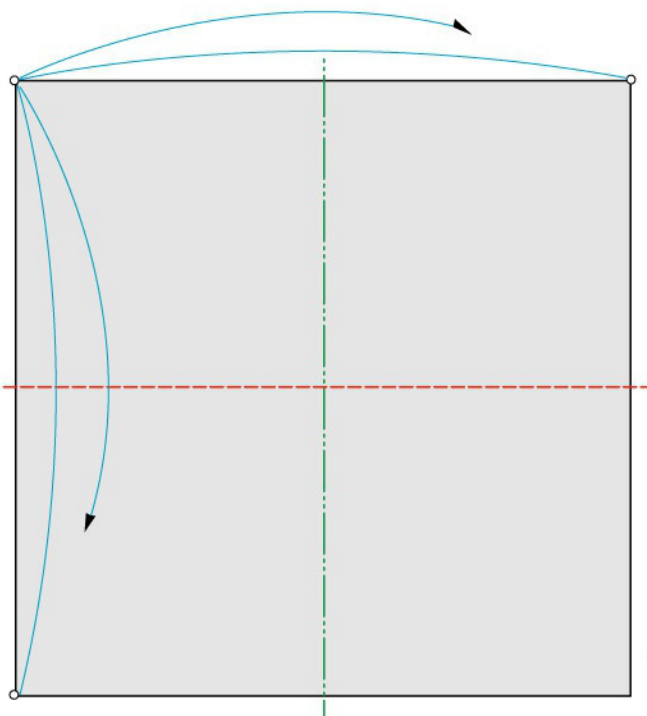
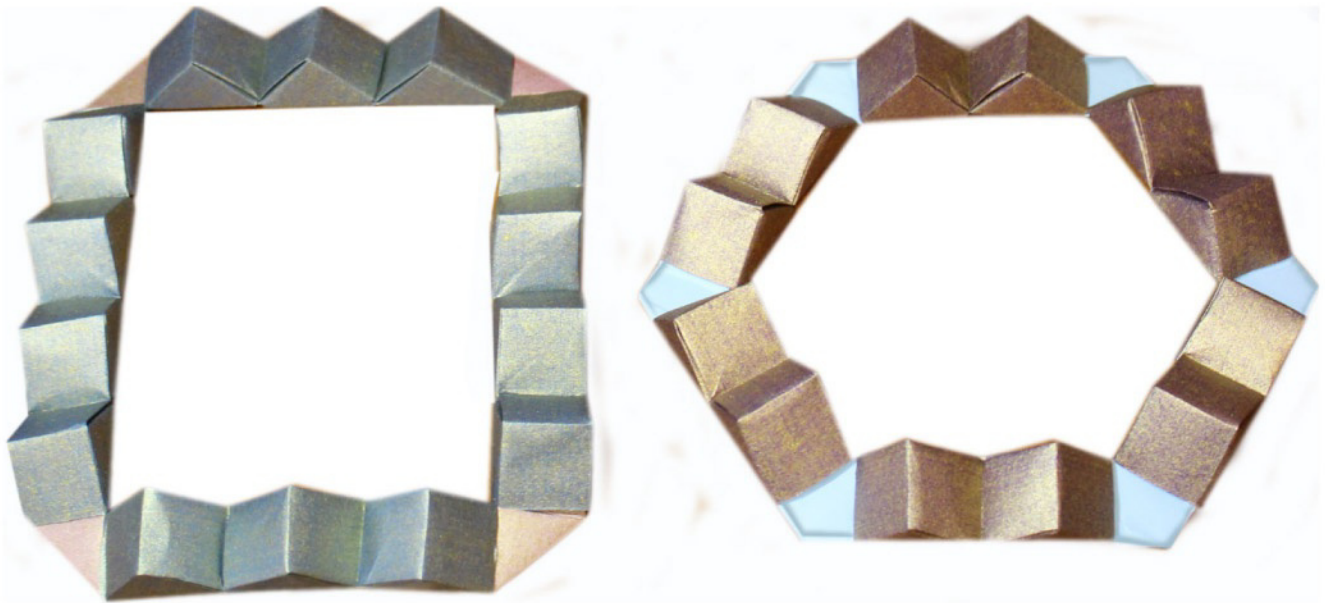

1 piega a valle e 1 a monte

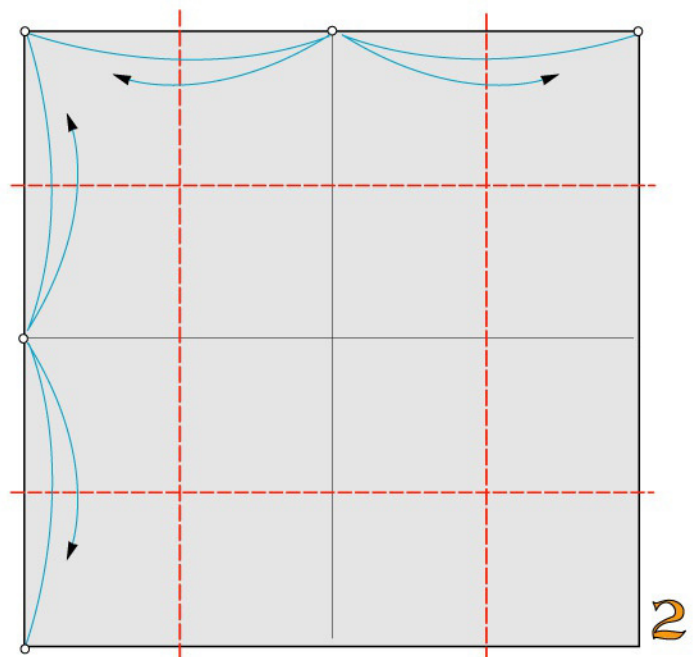

4 pieghe a valle

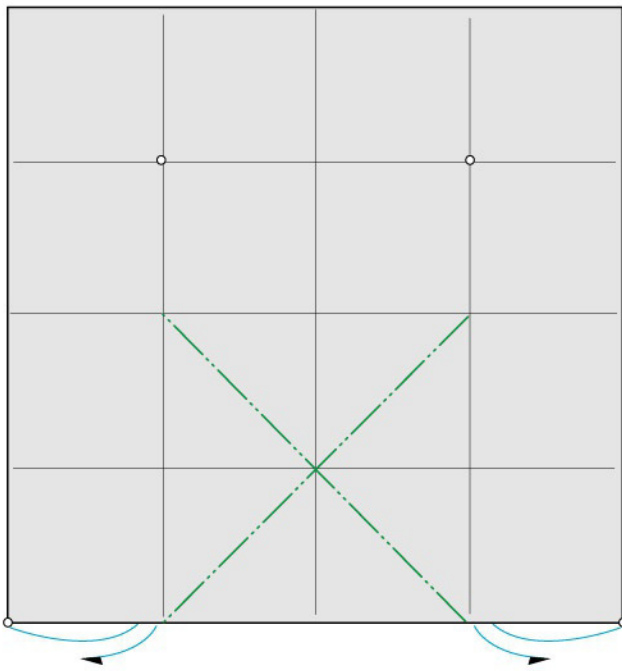

2 pieghe diagonali a monte

3

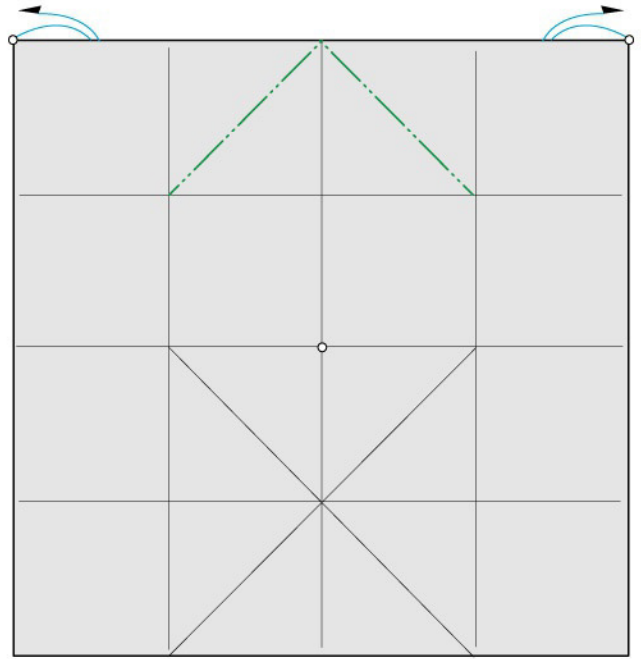

2 pieghe diagonali a monte

4

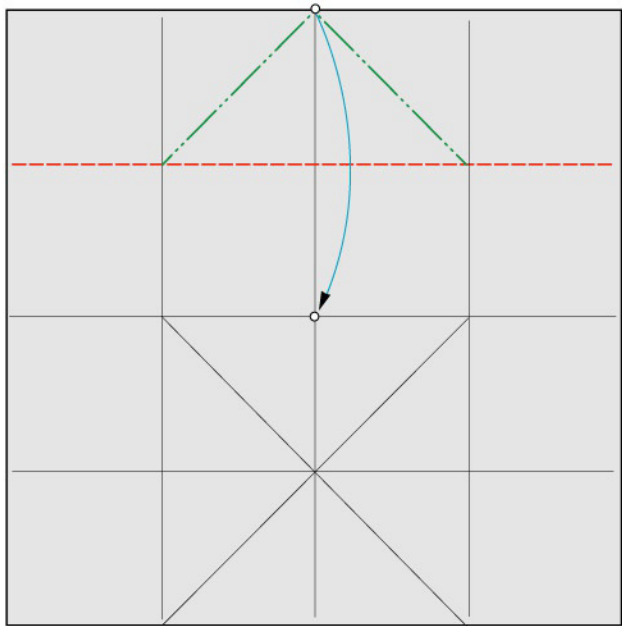

Ripiegate a valle e a monte

5

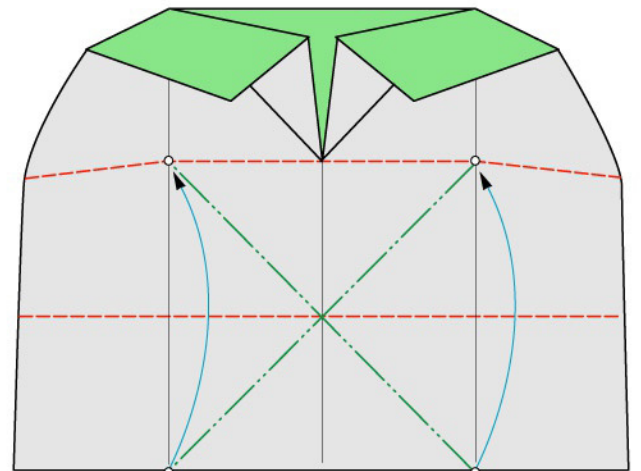

Ripiegate a valle e a monte modellando 3D

6



Ripiegate a monte

7

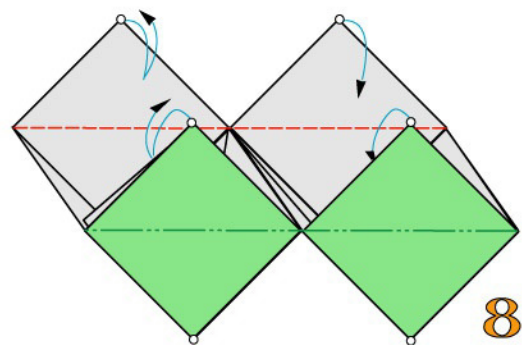

4 pieghe a monte, 2 per lato

8

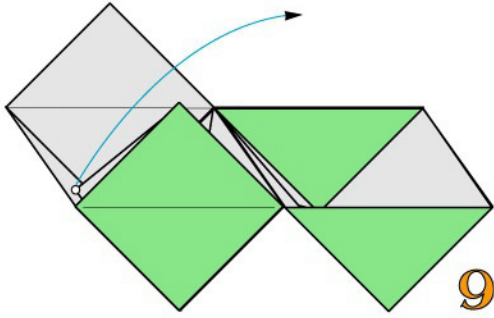

Estraete la superficie indicata

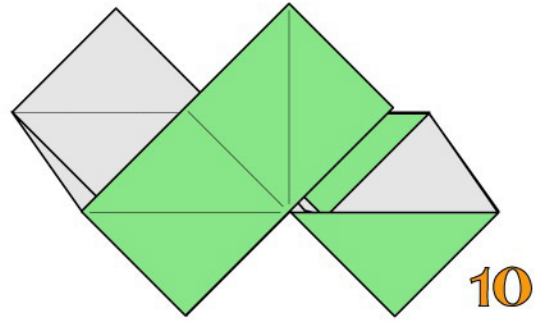

Modulo-base ultimato

UNIONE DEI MODULI

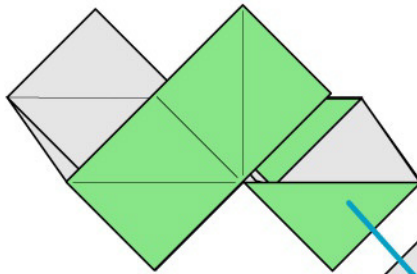

Inserite parzialmente un modulo nell'altro

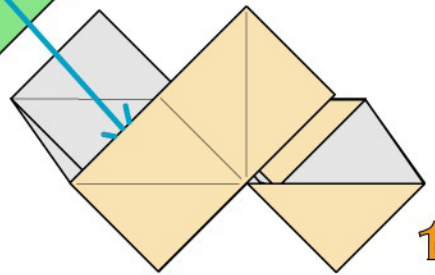

1

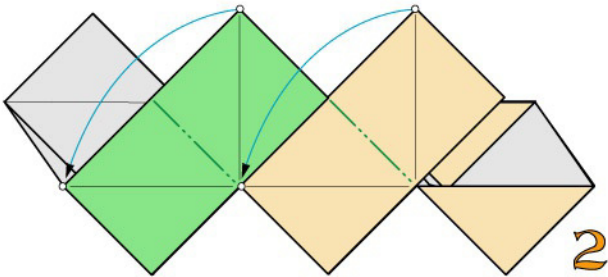

Ripiegate a monte

2

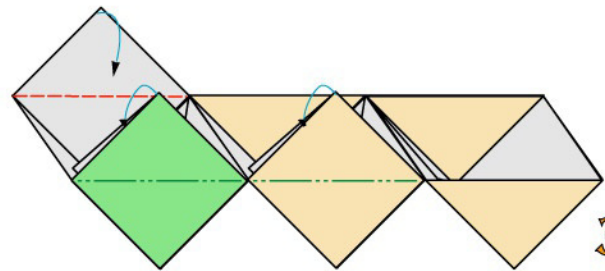

Mediante pieghe a monte bloccate l'unione

3

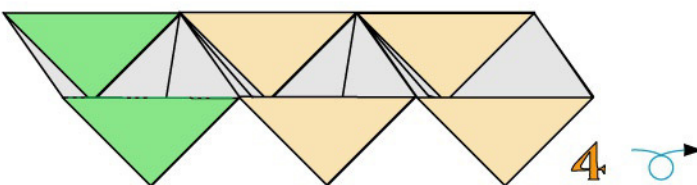

Unione completata, lato interno

4

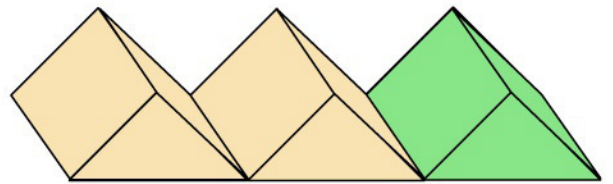

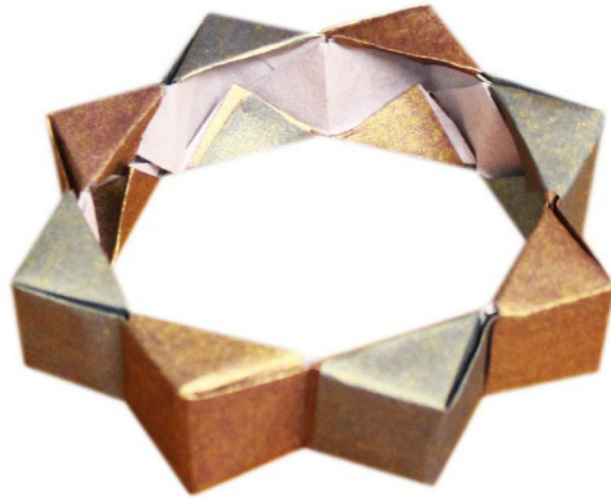

MODULO A "90°"

Con un modulo apposito è possibile variare di 90° la direzione del nastro

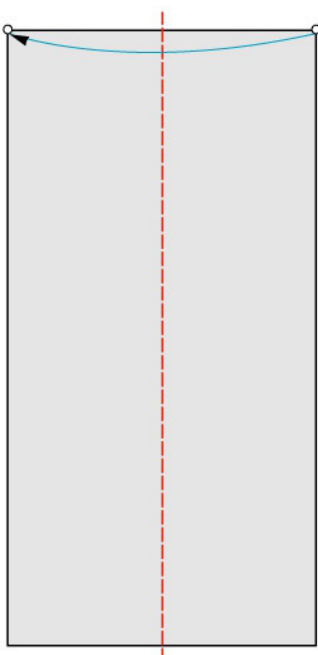
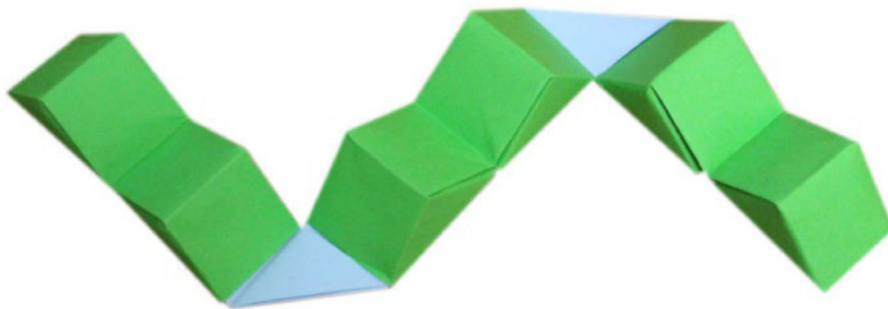

1 piega a valle

1

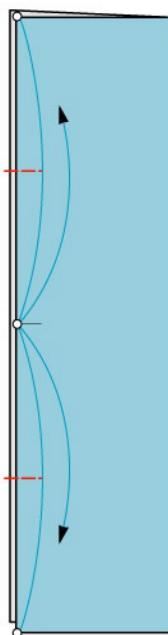

2 piccole pieghe a valle

2

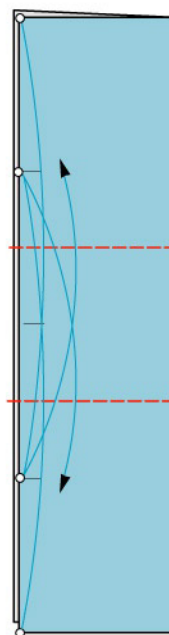

2 pieghe a valle

3

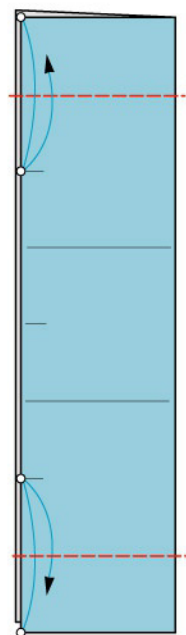

2 pieghe a valle

4

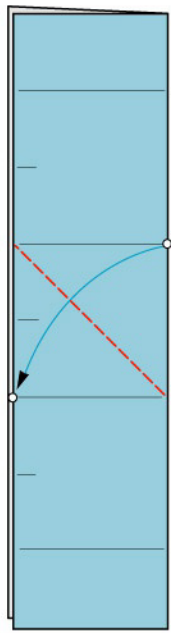

5

1 piega diagonale a valle

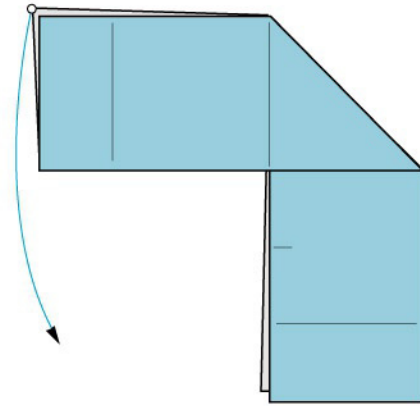

6

Aprite

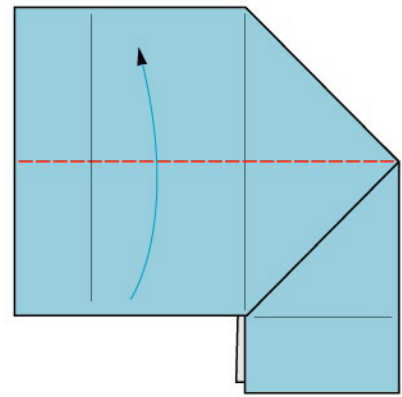

7

Ripiegate a valle

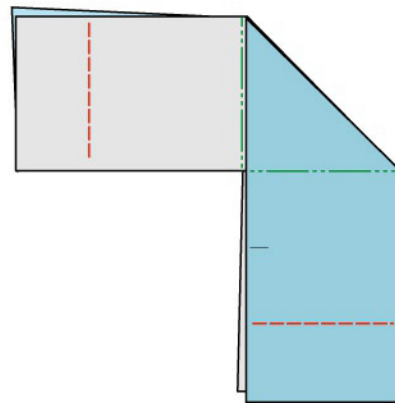

8

Ripiegate a valle e a monte

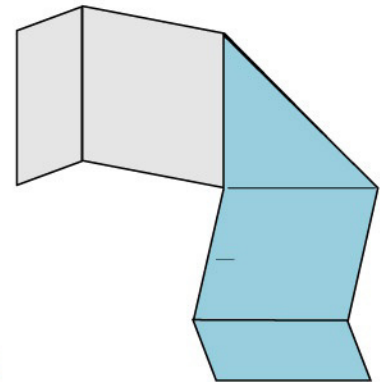

9

Modulo "a 90°" ultimato

UNIONE DEI MODULI

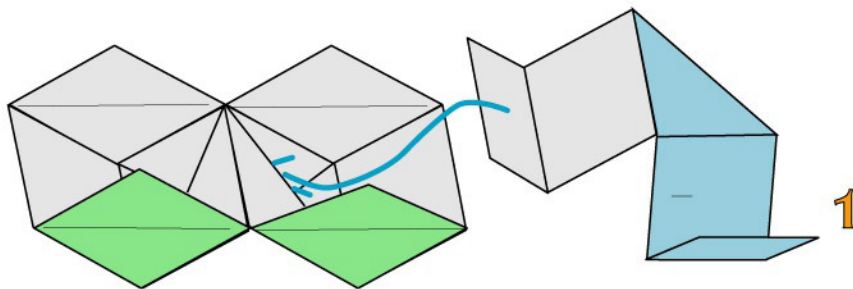

1

Intascate l'estremità del modulo "a 90°" entro un modulo-base

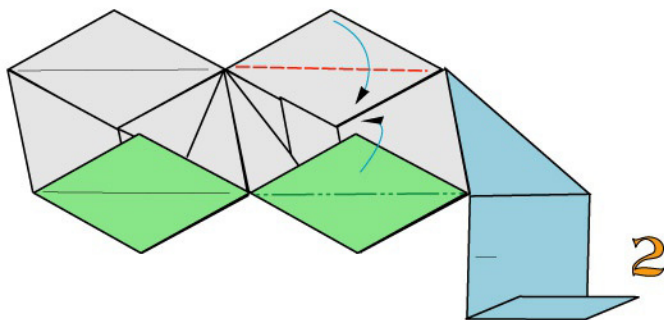

2

Mediante 2 pieghe a monte, 1 per lato, bloccate l'unione

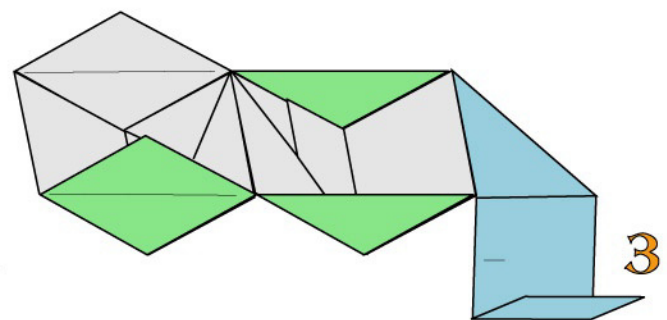

3

Unione completata

MODULO A "60°"

Con un modulo apposito è possibile variare di 60° la direzione del nastro

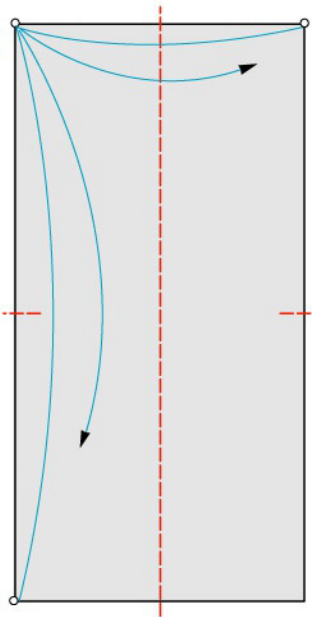

1

3 pieghe a valle, di cui 2 piccole

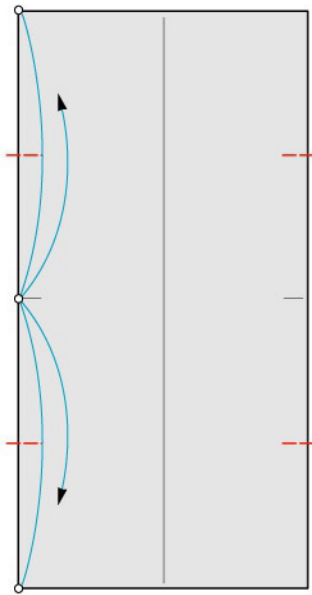

2

4 piccole pieghe a valle

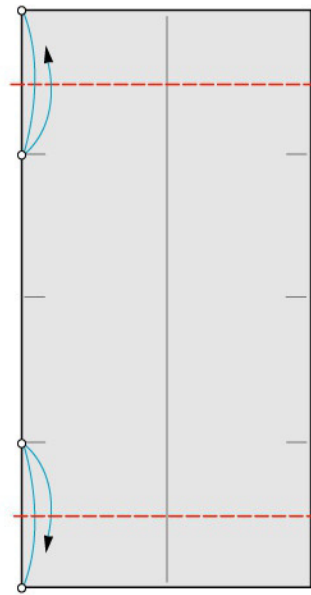

3

2 pieghe a valle

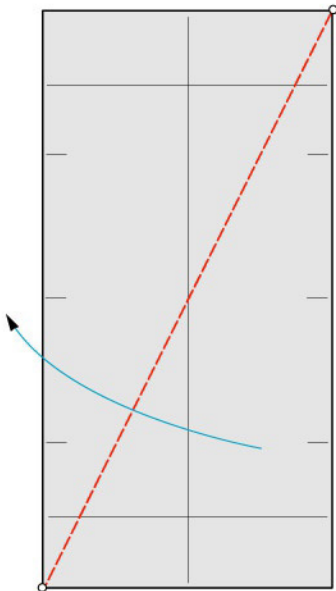

1 piega diagonale a valle

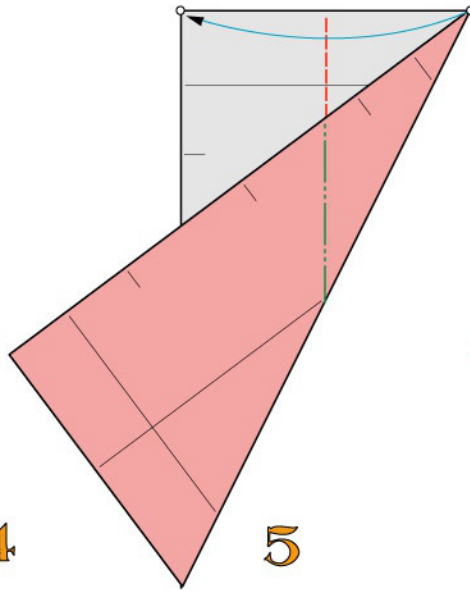

4

1 piega rovescia interna

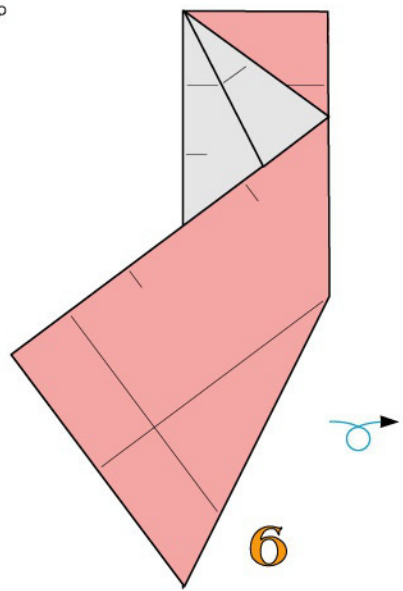

6

Ribaltate

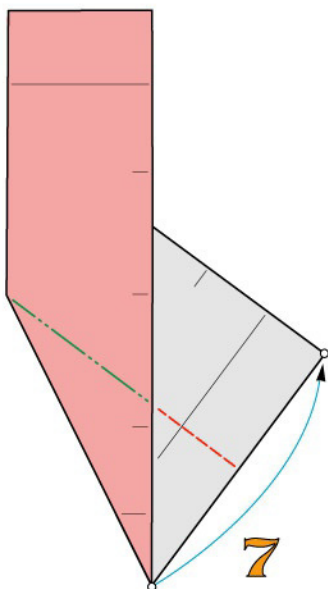

7

1 piega rovescia interna

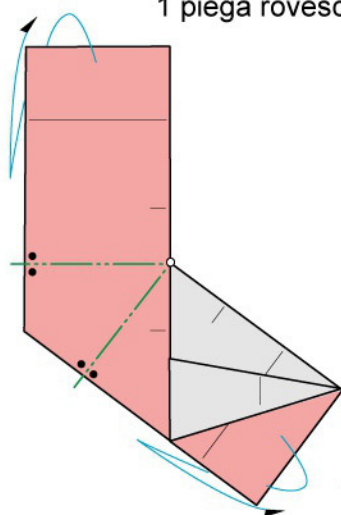

8

2 pieghe a monte

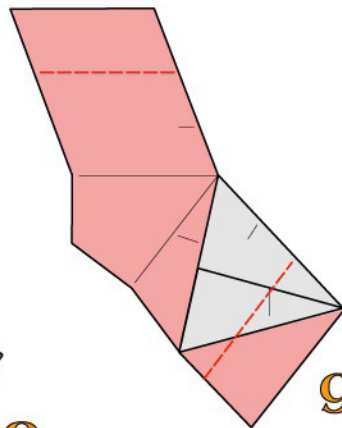

9

2 pieghe a valle

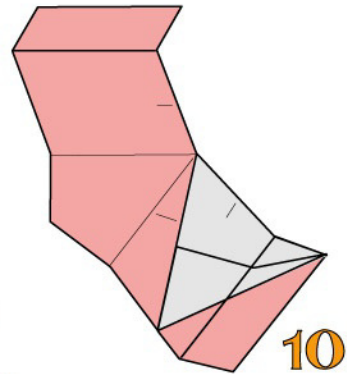

10

Modulo "a 60°" ultimato

NASTRO AZTECO



Sistema costruttivo modulare che permette la realizzazione di nastri e tassellazioni, non difficili da piegare ma che richiede una buona dose di precisione.

È costituito da un modulo base "A" ed una serie di moduli chiamati "Bn", tutti realizzati partendo da fogli quadrati monocolori o bicolori della medesima dimensione.

Per la costruzione dei moduli "A" adoperate carta leggera o di medio peso; risultati originali si ottengono adoperando carta metallizzata.

Per la costruzione dei moduli "B" adoperate carta medio-pesante, comunque di spessore maggiore di A.

MODULO A

Si legano un modulo A ed uno B, alternati, per formare un nastro rettilineo

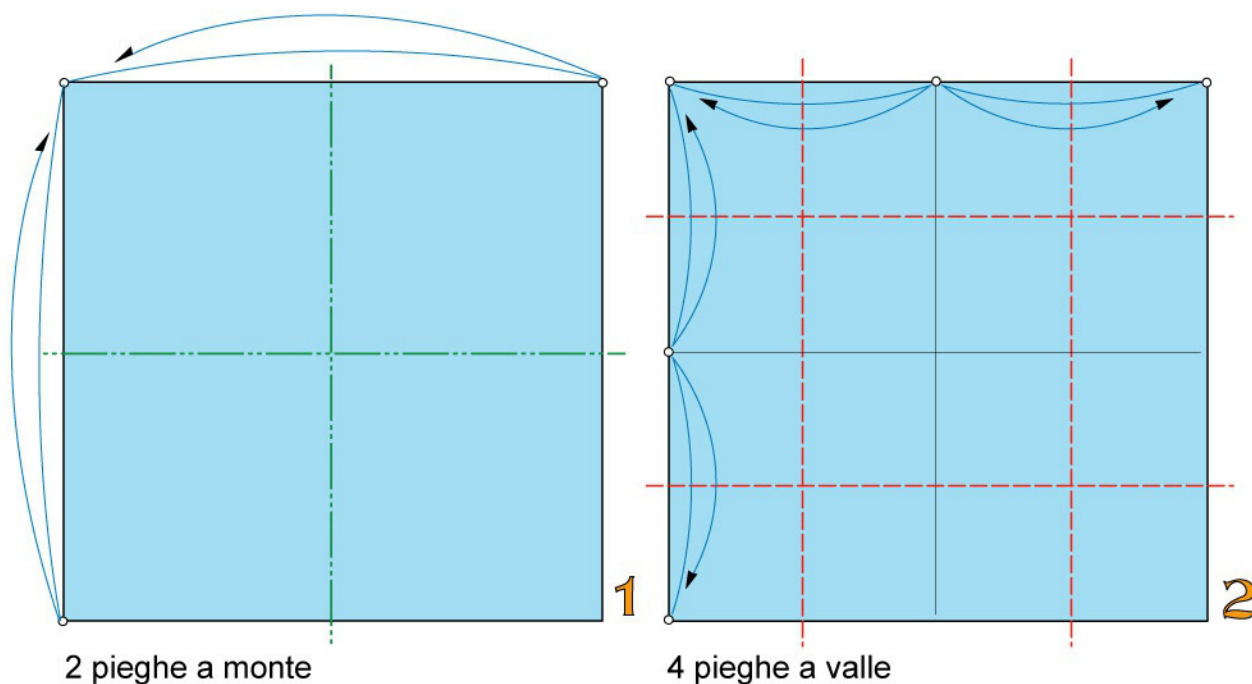

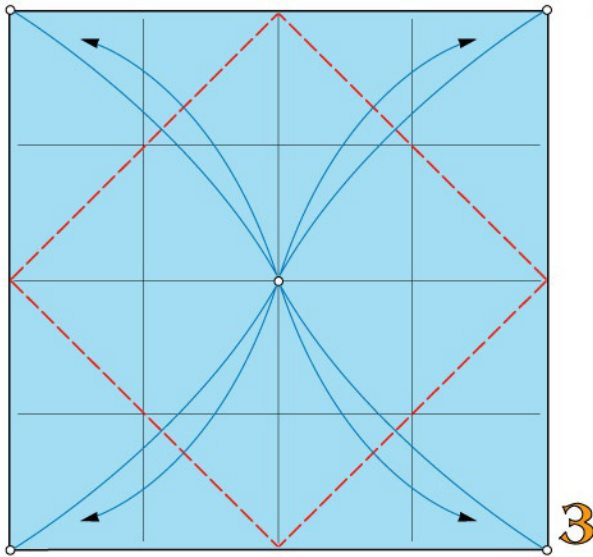

4 pieghe a valle

3

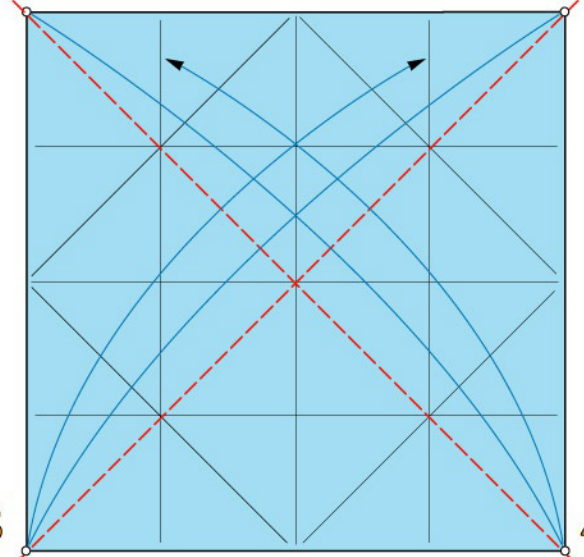

2 pieghe diagonali a valle

4

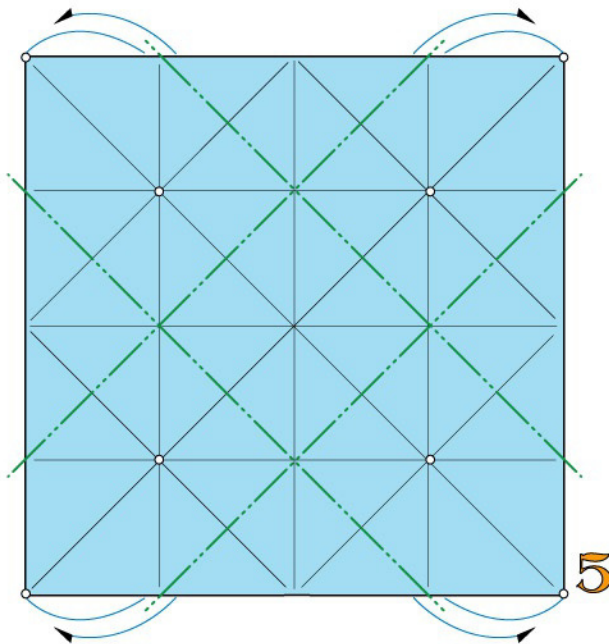

4 pieghe a monte

5

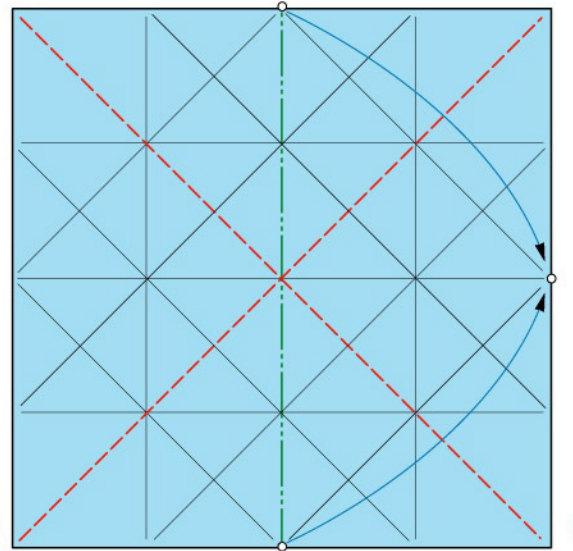

Ruotate ripiegando a valle ed a monte

6

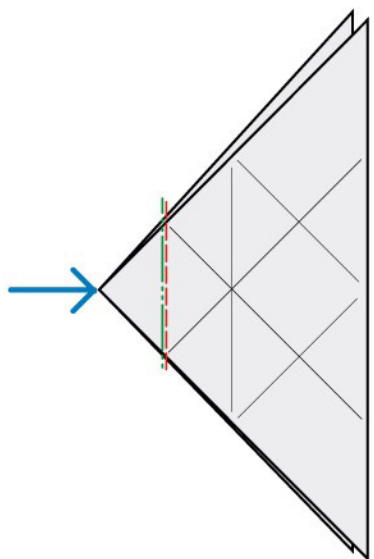

7

Piegate a valle ed a monte sulla stessa traccia e fate rientrare il vertice

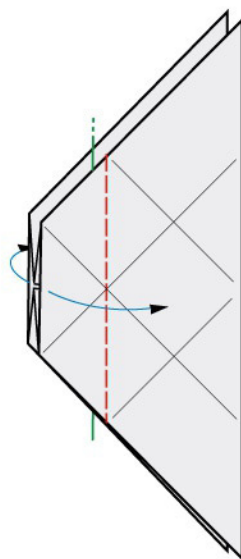

8

“Aprite” ripiegando a valle

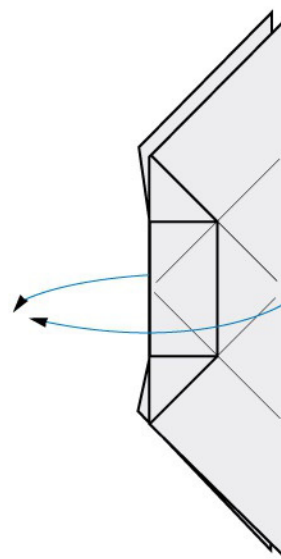

9

“Aprite” ripiegando a valle

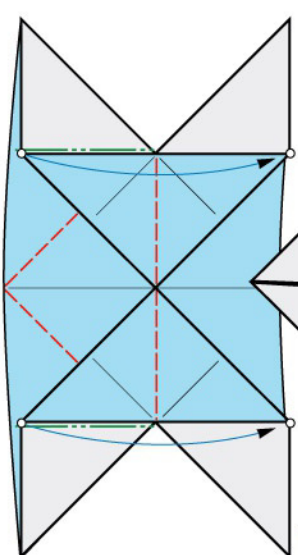

10

Ruotate ripiegando a valle ed a monte

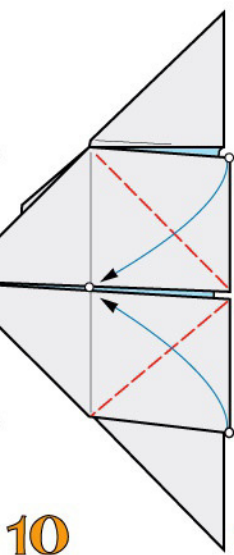

11

Ruotate ripiegando a valle

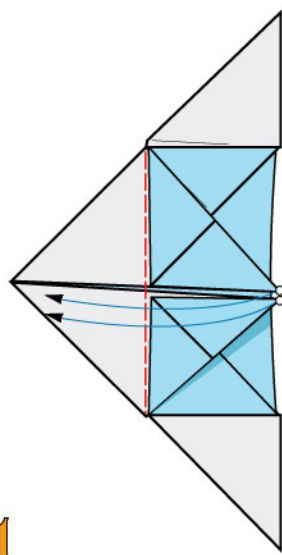

12

Ruotate ripiegando a valle

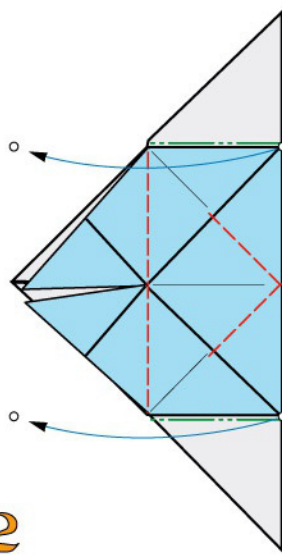

13

Ruotate ripiegando a valle ed a monte

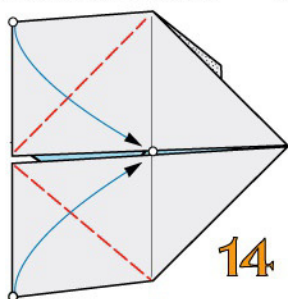

14

Ruotate ripiegando a valle

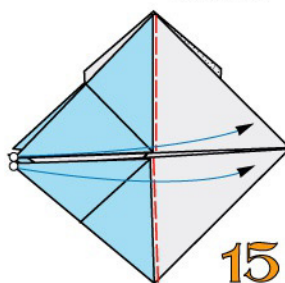

15

Ruotate ripiegando a valle

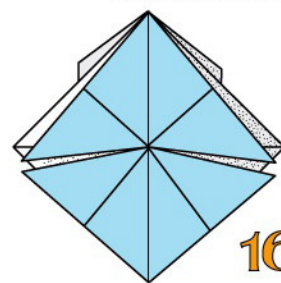

16

Modulo “A” ultimato

MODULO B

Consiglio adoperare per questo modulo carta robusta medio/pesante

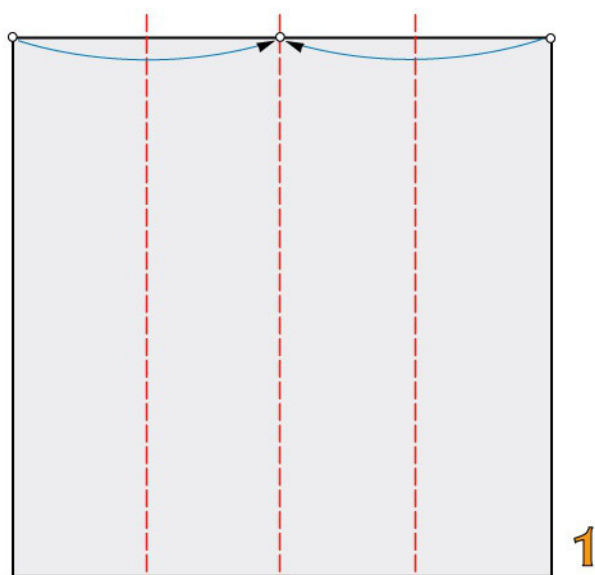

1

3 pieghe a valle e ruotate lateralmente, distanziando pochissimo i bordi (1/2 mm). Ribaltate

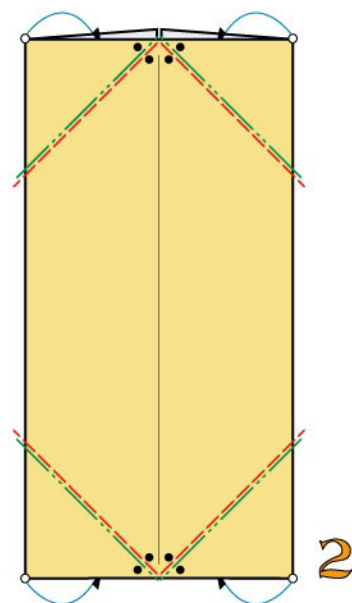

2

4 pieghe rovesce interne

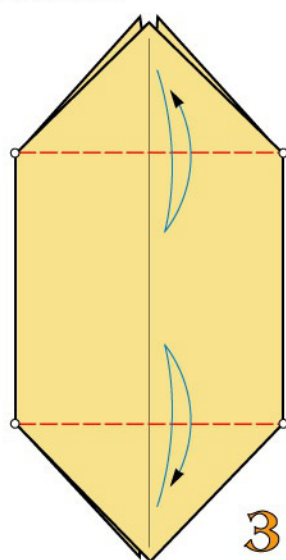

3

2 pieghe a valle

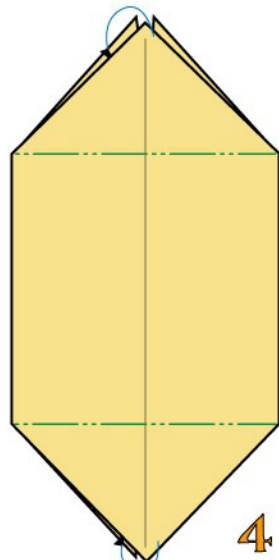

4

2 pieghe a monte e ruotate all'interno

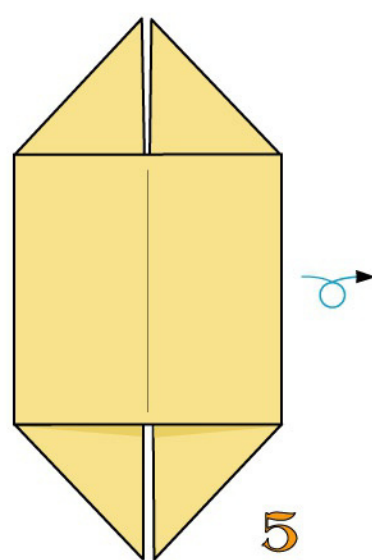

5

Modulo "B" ultimato

UNIONE DEL MODULO "A" CON IL MODULO "B"

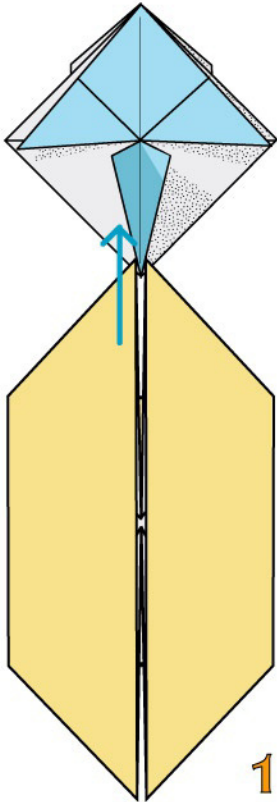

1

Sollevare 2 alette del modulo "A" ed eseguire un incastro a forchetta

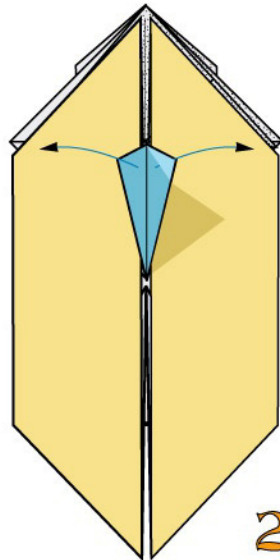

2

Riabbassate i vertici del modulo "A"

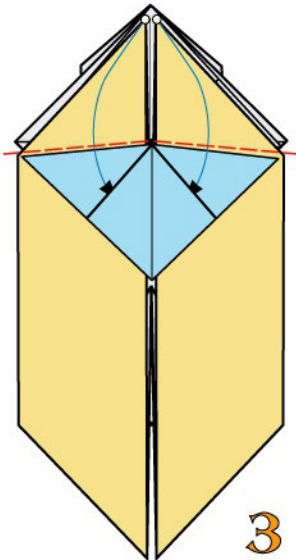

3

Aiutandovi con un piccolo cacciavite o forbici allargate le taschine e contemporaneamente mediante 2 pieghe a valle intascate i vertici del modulo b

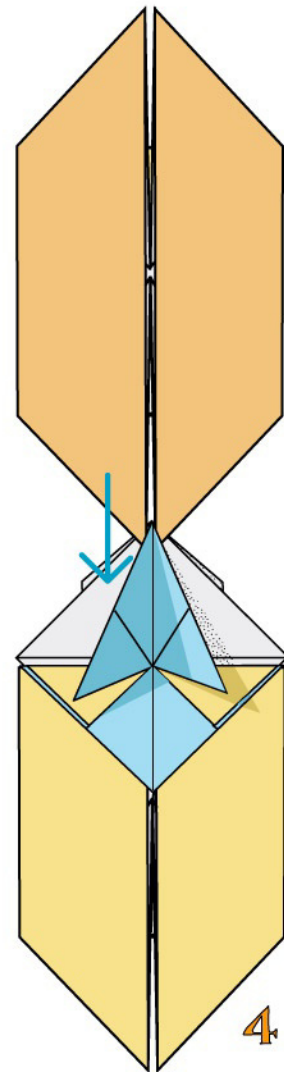

4

Similmente a quanto effettuato nel passaggio precedente, incastrate a forchetta

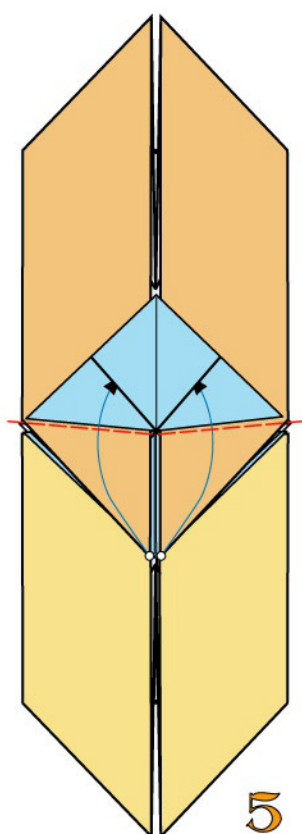

5

Similmente a quanto effettuato nel passaggio precedente, intascate e bloccate

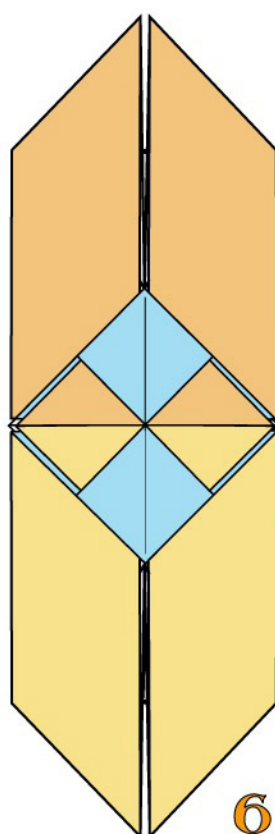

6

Unione di 2 moduli "B" con 1 modulo "A" ultimata

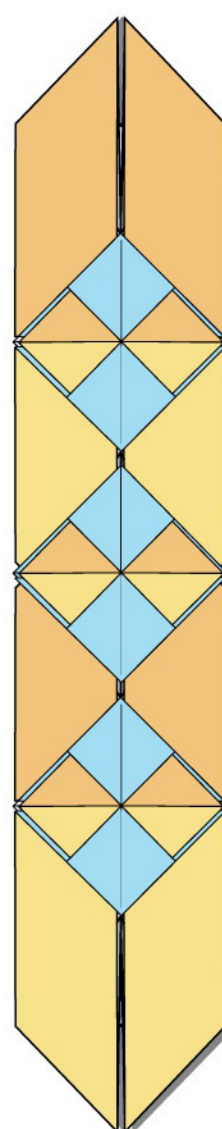

Nastro azteco formato da 3 moduli "A" e 4 moduli "B"



Bracciale formato da 5 moduli "A" e 5 moduli "B"

MODULO B 90°

Questo modulo consente una variazione di direzione di 90°. È formato da 2 elementi, che si uniscono tra loro prima di legarsi con il modulo "A"

ELEMENTO 1

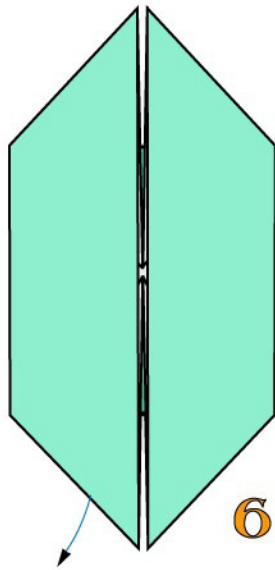

6
Partite da un modulo "B".
Estraete le superfici interne

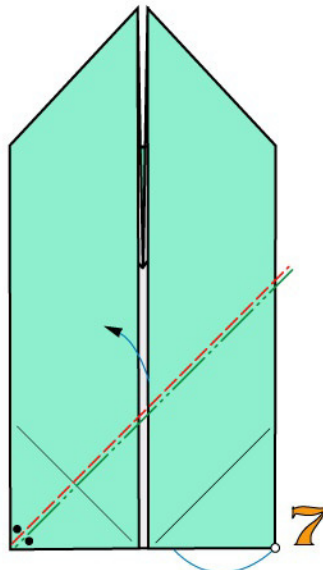

7
Eseguite una piega
rovescia interna

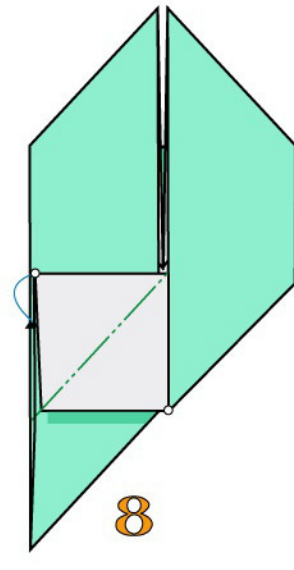

8
Una piega a monte e
ruotate all'interno

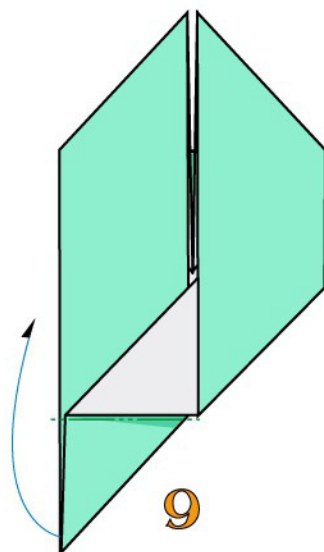

9
Una piega a monte e ruotate

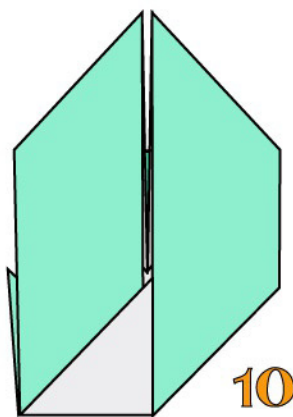

10
Elemento 1 ultimato

ELEMENTO 2

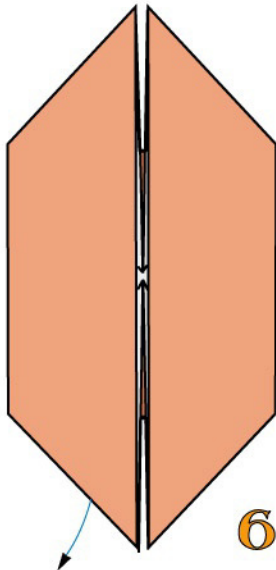

6

Partite da un modulo "B".
Estraete le superfici interne

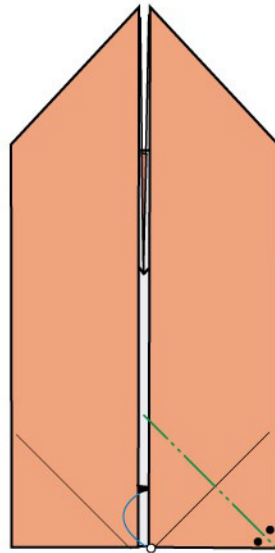

7

Una piega a monte e
ruotate all'interno

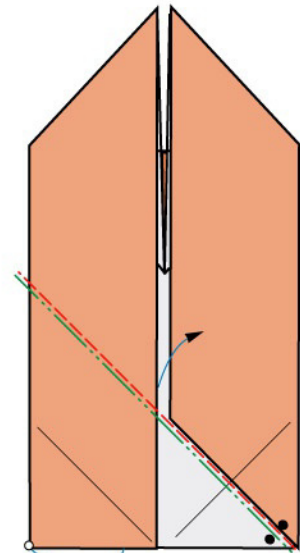

8

Una piega rovescia
interna

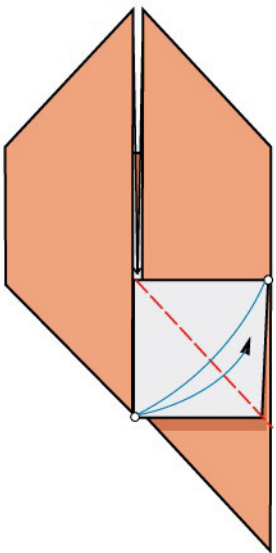

9

Una piega a monte

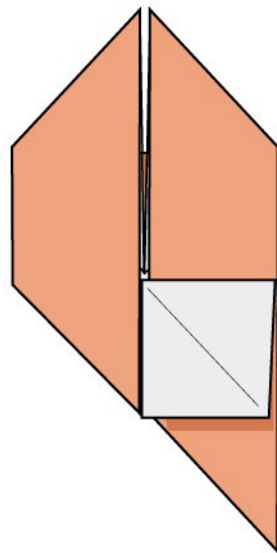

10

Elemento 2 ultimato

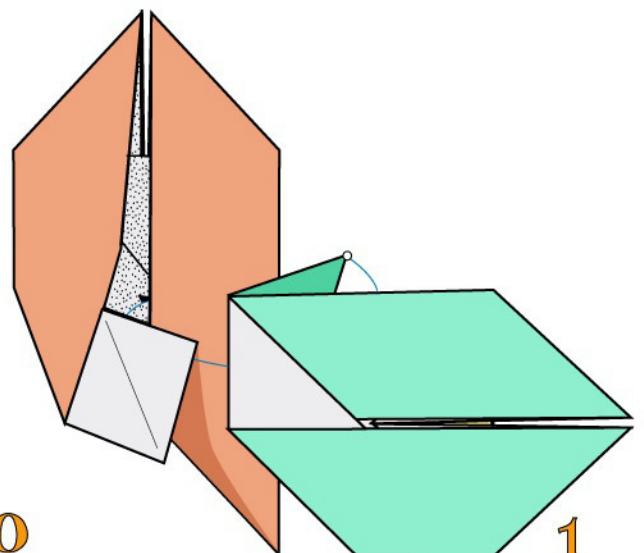

1

UNIONE DEI 2 ELEMENTI
Ruotate di 90' il modulo B ed
agganciatelo entro A

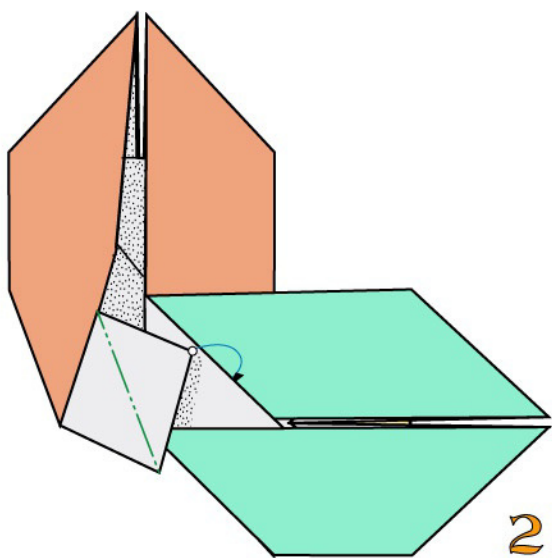

Bloccate l'unione intascando con piega a monte il vertice indicato dell'elemento 2

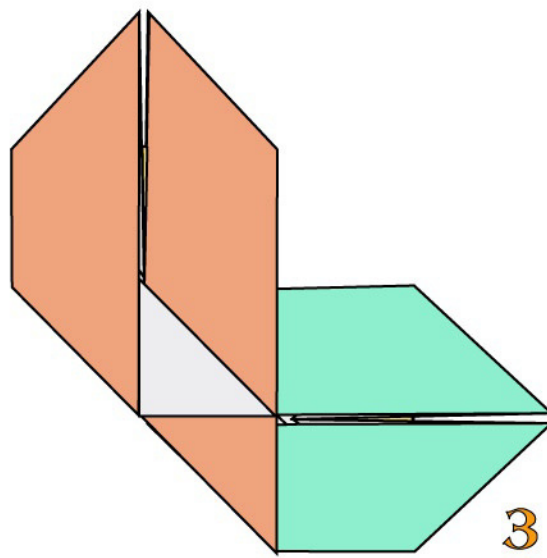

Modulo B 90° ultimato

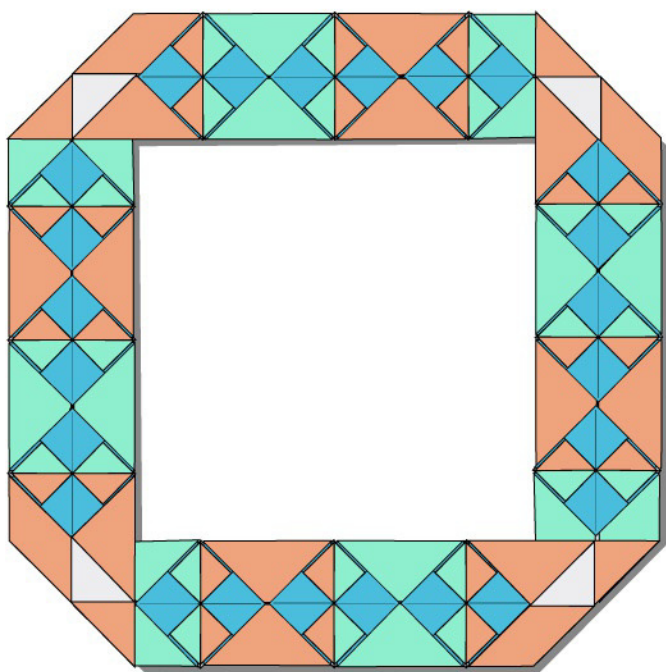

Cornice con 12 moduli A, 8 moduli B e 4 moduli B 90°

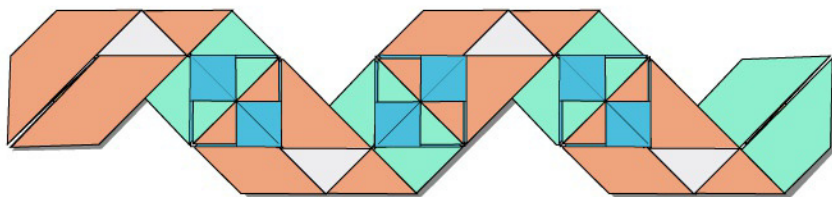

Nastro con 3 moduli A e 4 moduli B 90°



MODULO B 45° sin

Questo modulo consente una variazione di direzione di 45°. È formato da 2 elementi, che si uniscono tra loro prima di legarsi con il modulo "A"

ELEMENTO 1

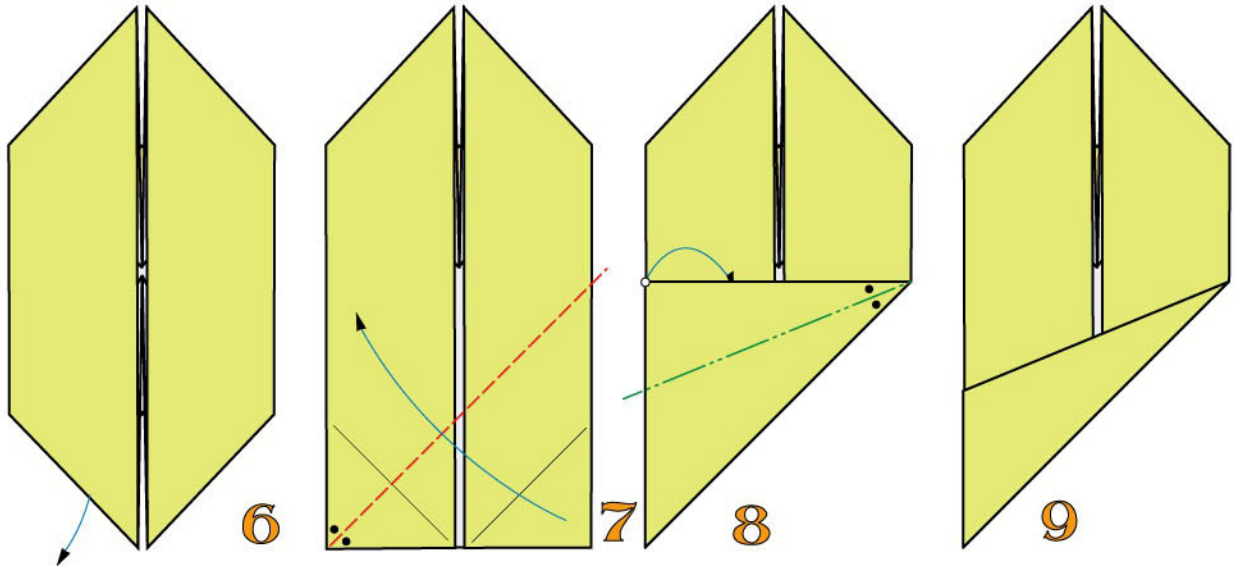

Partite da un modulo "B".
Estraete le superfici interne

Una piega bisettrice a valle e ruotate

Una piega bisettrice a monte e ruotate

Elemento 1 ultimato

ELEMENTO 2

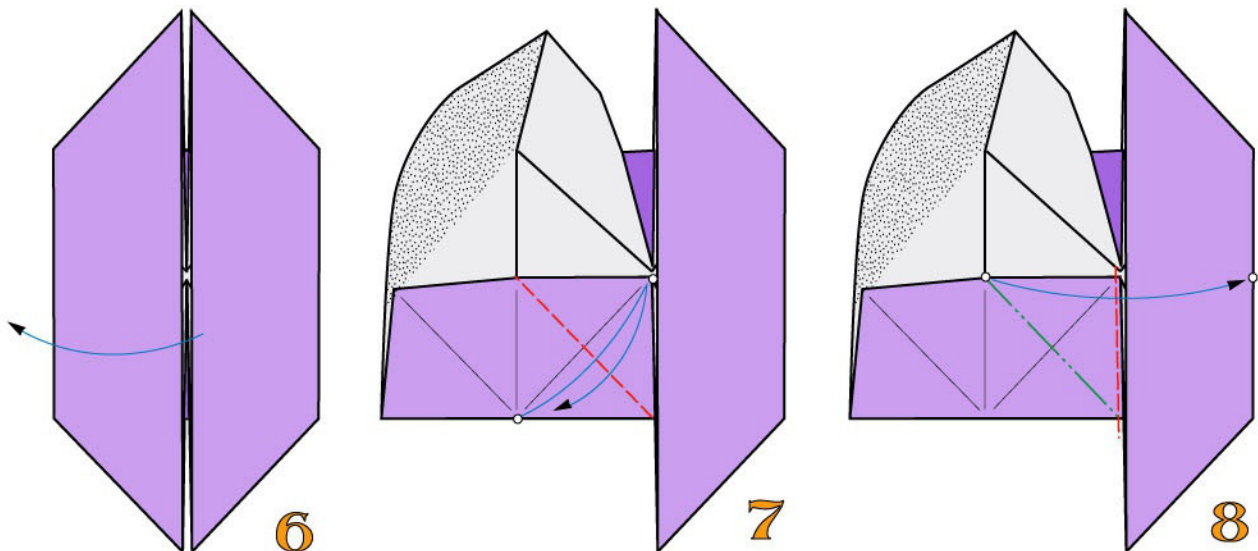

Partite da un modulo "B".
Aprite 3D la parte sinistra

1 piega a valle.

1 piega a valle, 1 a monte solo sulla sup. in vista e ruotate 3D

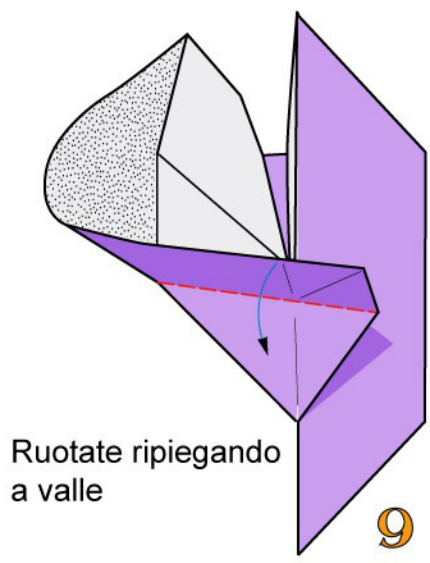

Ruotate ripiegando a valle

9

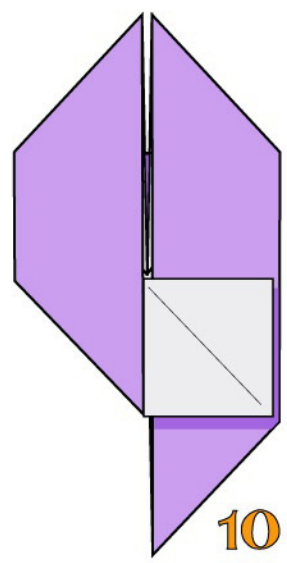

Elemento 2 ultimato

10



UNIONE DEI 2 ELEMENTI>
Inserite l'elemento 1 entro l'elemento 2

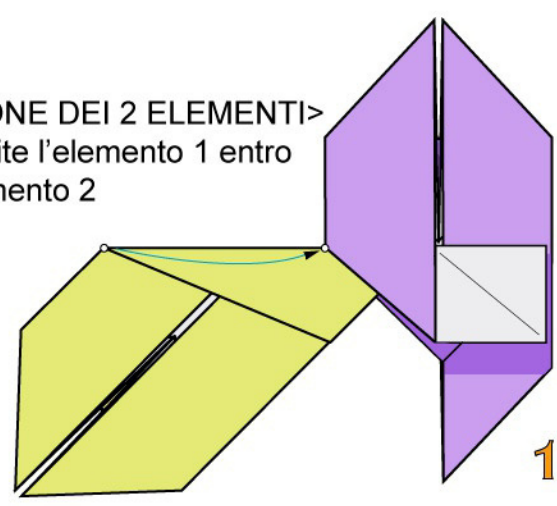

1

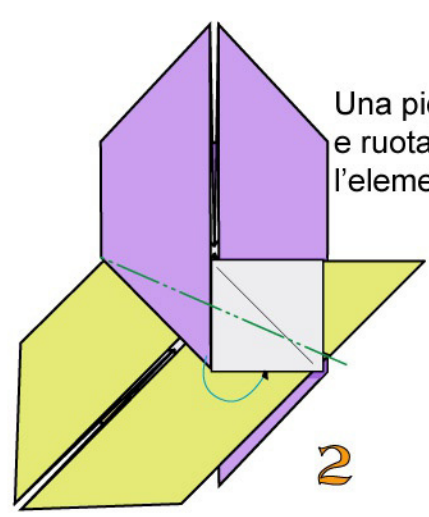

2

Una piega a monte e ruotate bloccando l'elemento 1

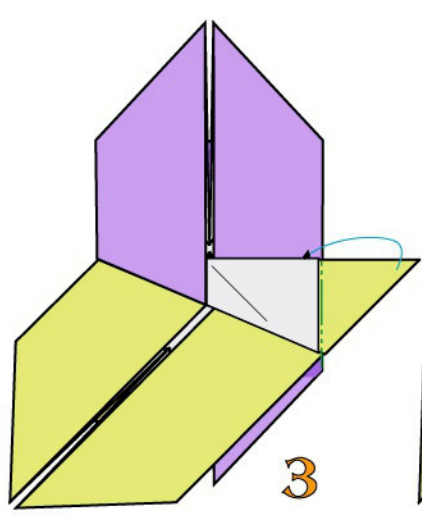

3

Una piega a monte e ruotate bloccando l'elemento 1

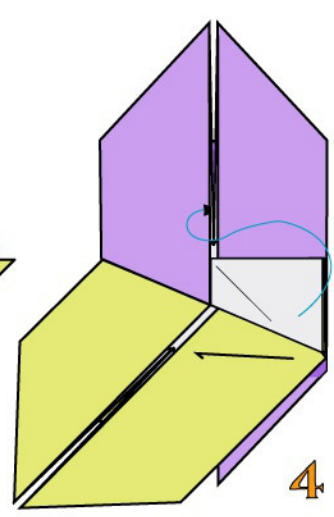

4

Inserite la superficie indicata all'interno della tasca sottostante

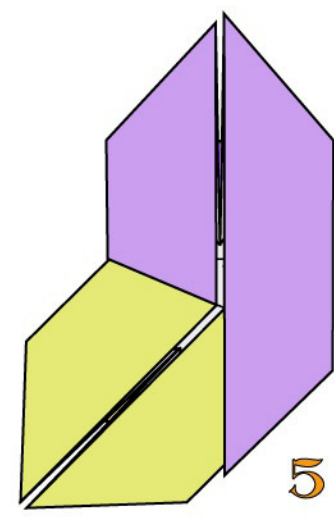

5

Modulo B 45° sin. ultimato

MODULO B 45° dest

Questo modulo consente una variazione di direzione di 45°. È formato da 2 elementi, che si uniscono tra loro prima di legarsi con il modulo "A"

ELEMENTO 1

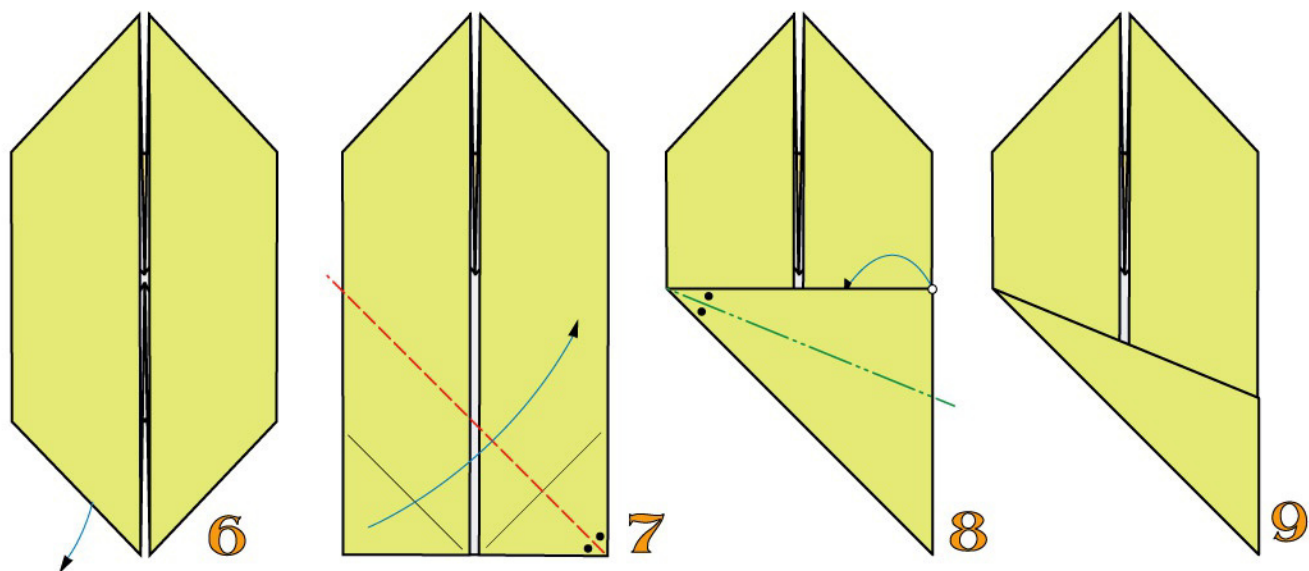

Partite da un modulo "B".
Estraete le superfici
interne

Una piega bisettrice
a valle e ruotate

Una piega bisettrice
a monte e ruotate

Elemento 1
ultimato

ELEMENTO 2

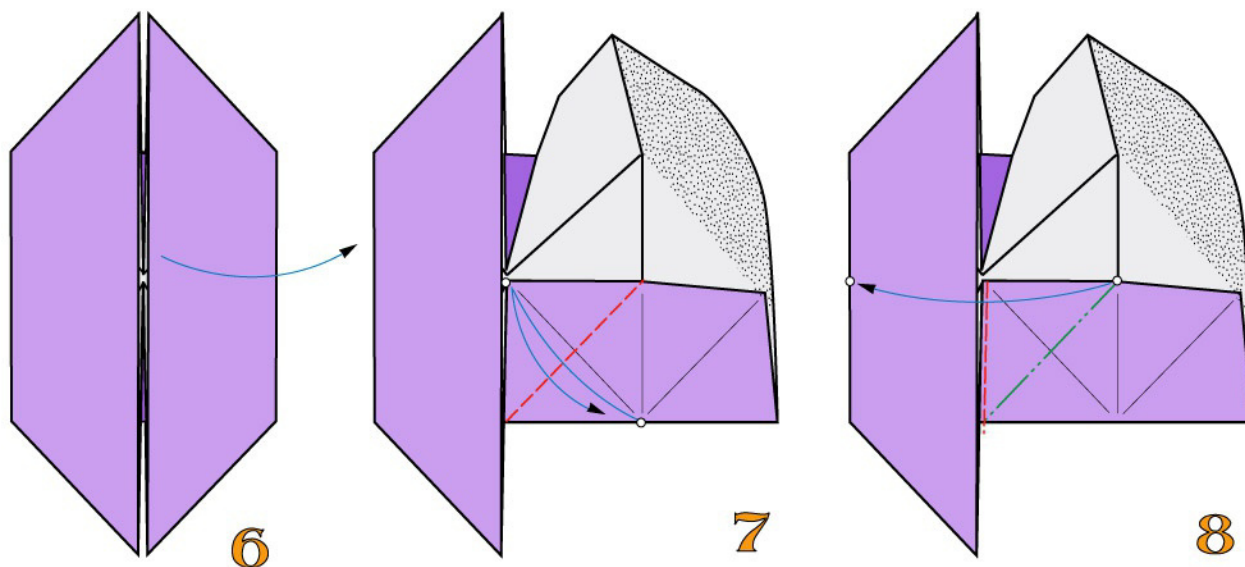

Partite da un modulo "B".
Aprite 3D la parte destra

1 piega a valle.

1 piega a valle, 1 a monte solo
sulla sup. in vista e ruotate 3D



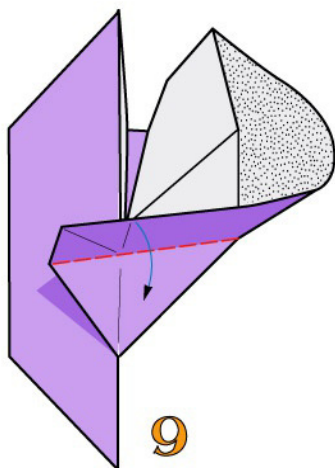

9

Ruotate ripiegando a valle

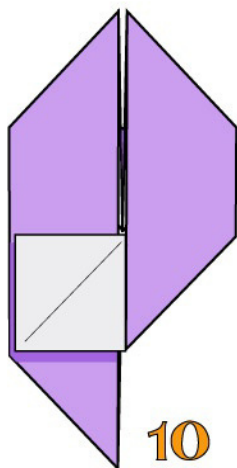

10

Elemento 2 ultimato

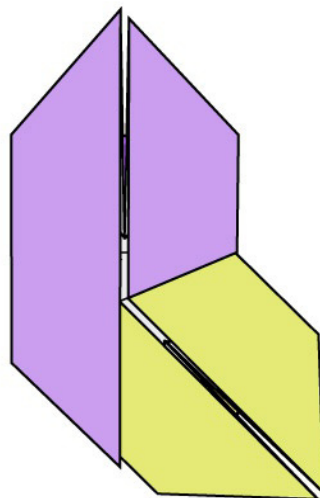

Unite i 2 elementi nel solito modo.
Modulo B 45° destro ultimato

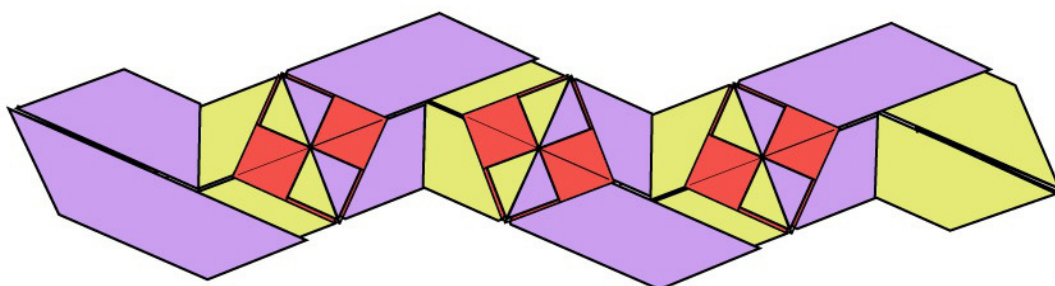

Nastro azteco realizzato con 3 moduli "A" e 4 moduli "B" 45°, totale 11 fogli



Cornice azteca realizzata con 8 moduli "A" e 8 moduli "B" 45°, totale 24 fogli

Tassellazione azteca

Per realizzare questa tassellazione occorre costruire uno specifico modulo formato da 3 fogli derivati da "B"

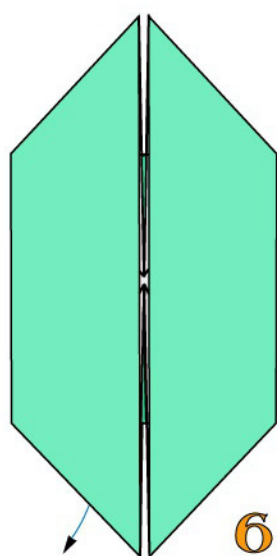

6

Partite da un modulo "B".
Estraete le superfici interne

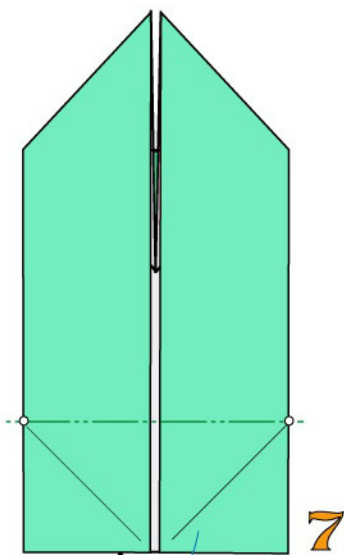

7

Una piega a monte e ruotate

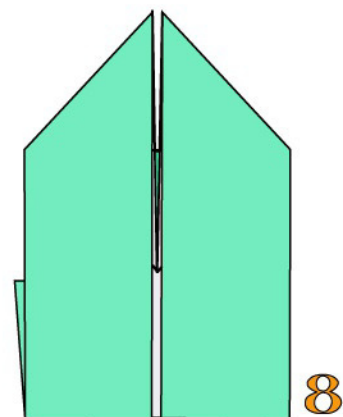

8

Elemento per tassellazione azteca ultimato

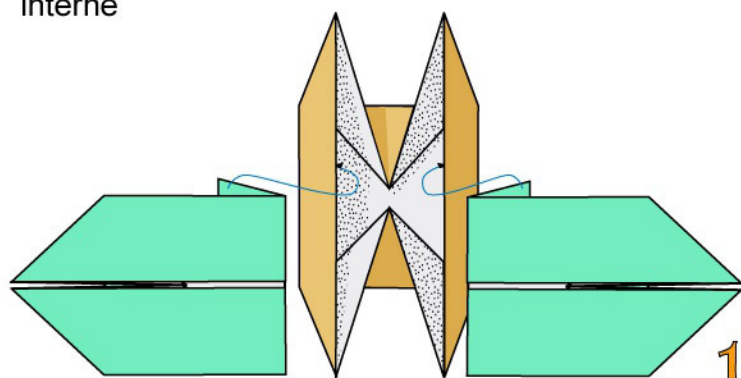

1

Costruite un modulo "B" con i bordi distanziati 1 mm.
Agganciate i 2 elementi nel modulo "B"

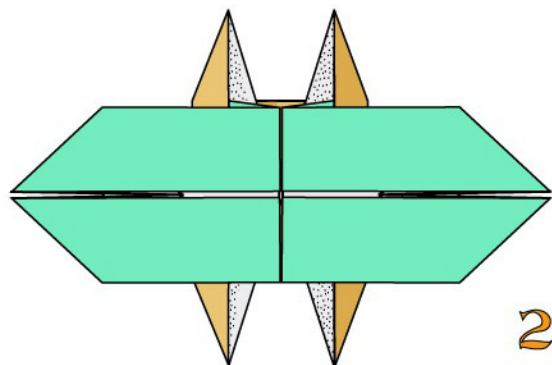

2

Chiudete il modulo "B" bloccando il tutto

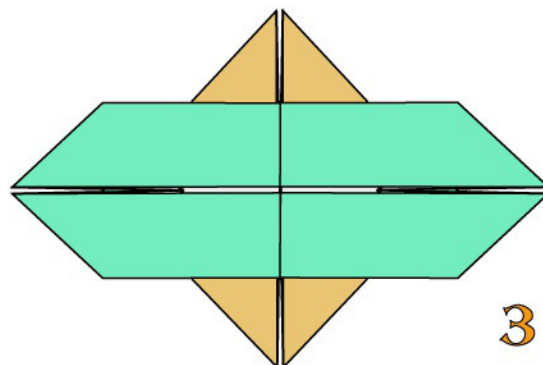

3

Modulo per tassellazione azteca ultimato

MONTAGGIO DELLA TASSELLAZIONE AZTECA

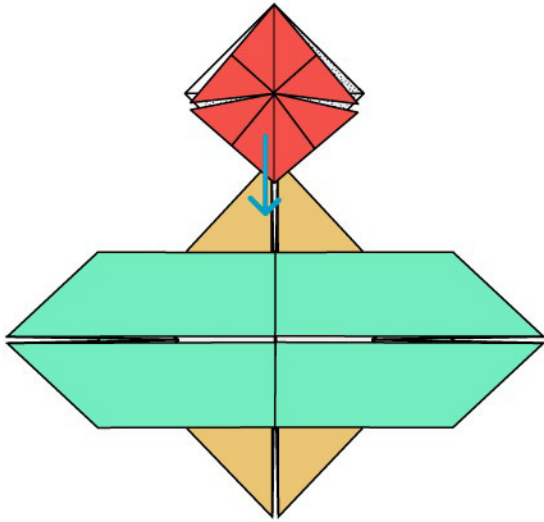

Inserite verticalmente e bloccate nel solito modo un modulo "A"

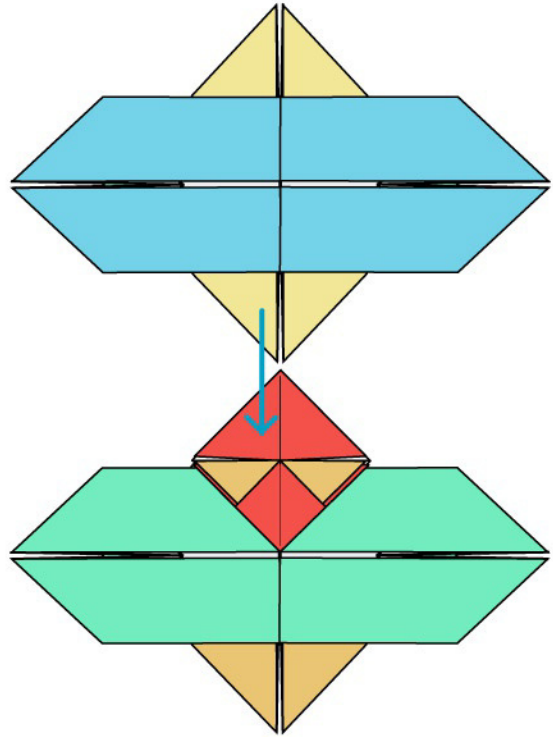

Inserite verticalmente e bloccate nel solito modo un modulo per tassellazione

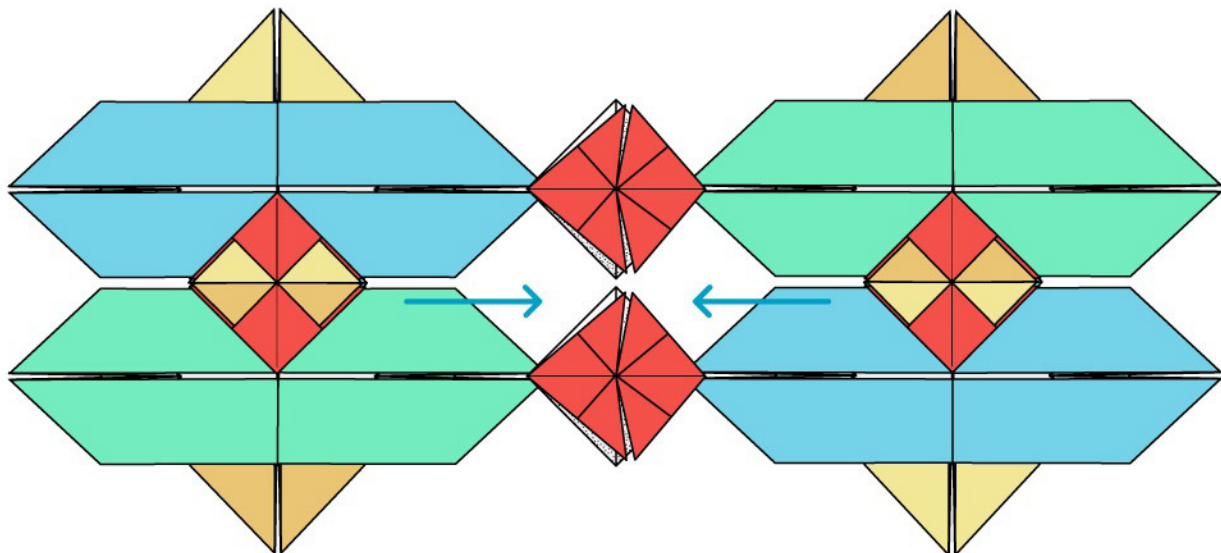

Inserite crizzionalmente e bloccate nel solito modo altri moduli per tassellazione e moduli "A"

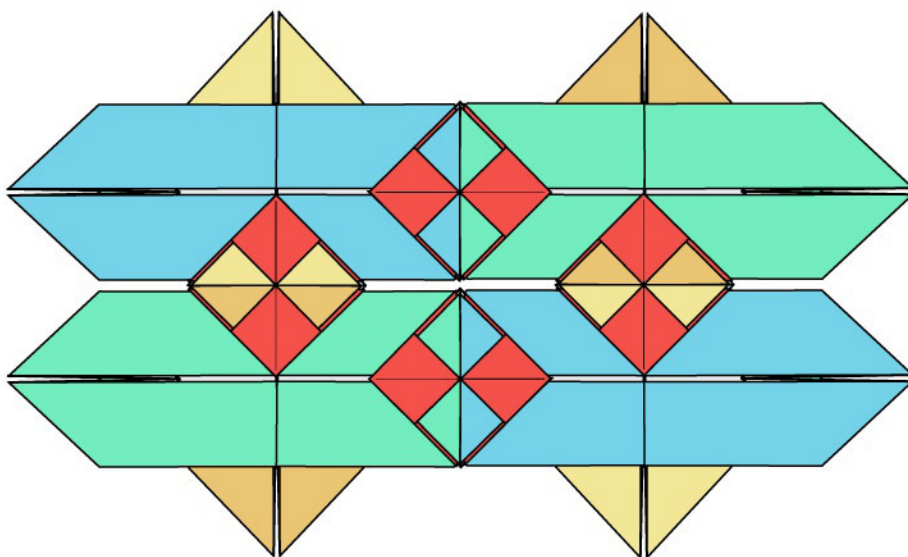

Tassellazione azteca formata da 4 moduli per tassellazione e 4 moduli "A", per un totale di 16 fogli

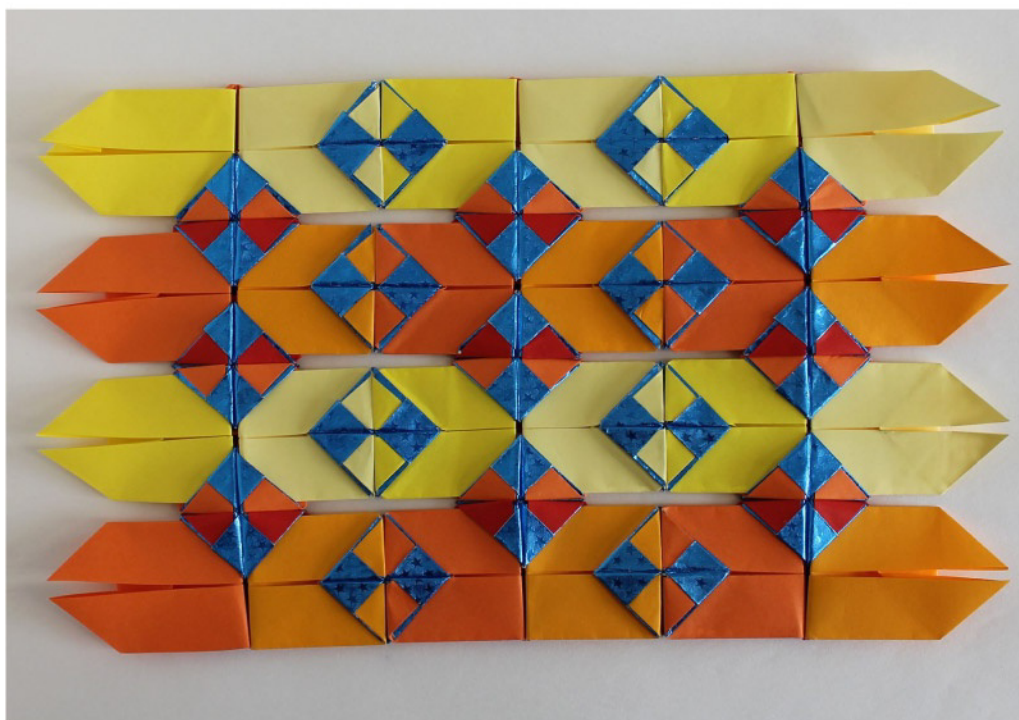

Tassellazione azteca formata da 12 moduli per tassellazione e 17 moduli "A", per un totale di 53 fogli



Tassellazione azteca prismatica formata da 12 moduli per tassellazione e 21 moduli "A", per un totale di 57 fogli

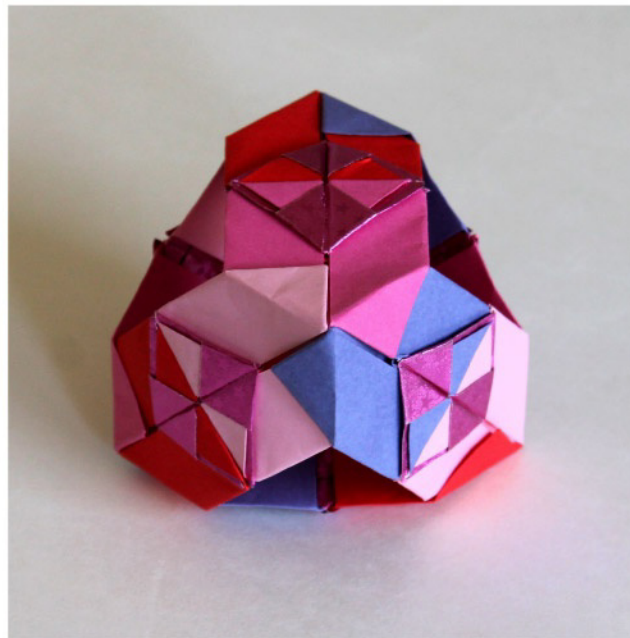

Cubo tronco formato da 4 moduli per tassellazione e 6 moduli "A", per un totale di 18 fogli

PUBBLICAZIONI DI FRANCO PAVARIN

Aerei , jet ed astronavi di carta volanti	IL CASTELLO	1986
Origami animati	“	1987
Origami maschere animate	”	1988
Decorazioni modulari con origami modulati	“	1989
Origami motoscafi navi barche e velieri	”	1990
Origami scatole e contenitori	“	1990
Pieghe forme e colori	”	1994
Aerei e navi di carta	FABBRI	1996
Fold and fly Paper airplanes	STERLING PUBLISHING	1998
Manuale rapido di aerei di carta volanti	FABBRI	2000
Aerei di carta 17 modelli volanti inediti	IL CASTELLO	2001
Aviones voladores	TUTOR S.A.	2003
17 modelos ineditos de aviones voladores	“	2004
Naves voladoras	”	2006
Quaderni Quadrato magico n.20 e 48	CDO	
Maschere, elmi e copricapi	web	2010
Maschere trasformabili	web	2011
21 nuovi aerei origami volanti	web	2014
Maschere origami 3D volume 1	web	2014
Maschere origami 3D volume 2	web	2015
Legorigami 1 -Q.Quadrato Magico n.56	CDO	2015
Composizione modulare 1	web	2016
Manuale dell'architetto origamista	web	2016
13 moduli origami aggregabili	web	2017
Alfabeti origami	web	2018
21 Elmi e strani copricapi origami	web	2019
Animalletti semplici origami	web	2020
Origami per giocare	web	2020
30 nuovi origami volanti	web	2021
Contenitori 1	web	2021
Contenitori 2	web	2021
Contenitori 3	web	2022
Contenitori 4	web	2022
Volti scolpiti origami 1	web	2018
Volti scolpiti origami 2	web	2019
Contenitori 5	web	2022

